

**VILLAGE OF DOWNERS GROVE  
REPORT FOR THE VILLAGE COUNCIL MEETING  
APRIL 10, 2012 AGENDA**

| <b>SUBJECT:</b>   | <b>TYPE:</b>  | <b>SUBMITTED BY:</b>                                   |
|---|---|--|
| Final Plat of Subdivision -<br>Resubdivision of Green Acres | <input checked="" type="checkbox"/> Resolution<br><input type="checkbox"/> Ordinance<br><input type="checkbox"/> Motion<br><input type="checkbox"/> Discussion Only | Tom Dabareiner, AICP<br>Community Development Director |

**SYNOPSIS**

A resolution for a Final Plat of Subdivision has been prepared to resubdivide three existing lots into two new lots. The property located at 401-403 Lynn Gremer Court and 6568 Fairview Avenue.

**STRATEGIC PLAN ALIGNMENT**

The goals for 2011-2018 identified *Exceptional Municipal Services*.

**FISCAL IMPACT**

N/A.

**UPDATE & RECOMMENDATION**

This item was discussed at the April 3, 2012 Village Council meeting. Staff recommends approval on the April 10, 2012 Active Agenda.

**BACKGROUND**

The petitioner is requesting approval of a final plat of subdivision to combine three existing lots into two new lots. These three lots were part of the Green Acres subdivision in 2004 and were designated for stormwater detention. However, because the on-site stormwater detention was modified and completed in an acceptable manner that does not require the use of all three lots, the petitioner is now requesting to combine three lots into two lots, with one becoming a buildable single family residential lot and the other containing all of the stormwater detention.

The three lots are part of the Green Acres Subdivision approved in 2004. The Green Acres Subdivision, zoned R-3 Single Family Residence, is located on the west side of Fairview Avenue just north of 66<sup>th</sup> Street. The original approval of the 14-lot subdivision included extension of Davane Lane and creation of Lynn Gremer Court.

In late 2011, the new owner of the Green Acres Subdivision completed on-site stormwater detention. The shape of the pond was modified so that it does not take up all of Lots 12, 13 and 14. As such, the petitioner is now proposing to resubdivide these three lots into two new lots. Lots 12, 13 and 14 would be renamed Lots One and Two. Lot One would become buildable single family residential lot, while Lot Two would

contain the entire stormwater detention basin. There would be no changes to Lots 1-11 of the original Green Acres Subdivision.

The developer is creating a new homeowners association for the Green Acres Subdivision. Lot Two and the detention facilities would be owned and maintained by this homeowners association. If the homeowners association fails to maintain the detention facility, a Special Service Area will allow the Village to levy a special tax on the property owners for the maintenance of the facility. The Village would then maintain the detention facilities. The SSA will appear on a future Council agenda.

The two proposed lots comply with Sections 28.1103(c) and 28.1104(c) of the Zoning Ordinance. The lots will meet the minimum lot dimension requirements for the R-3 zoning district and per Section 20.301 of the Subdivision Ordinance. The required five-foot wide public utility and drainage easements will be provided along the new side lot lines. A new blanket stormwater detention easement will be placed over Lot Two. All other required public utility and drainage easements already exist and adequately serve the subdivision. The lot dimensions are specified in the table below:

| <b>401-403 Lynn Gremer Ct &amp; 6568 Fairview Ave</b> | <b>Lot Width (req. 75 ft.)</b> | <b>Lot Depth (req. 140 ft.)</b> | <b>Frontage (req. 45 ft.)</b>    | <b>Lot Area (req. 10,500 sq. ft.)</b> |
|---|--------------------------------|---------------------------------|----------------------------------|---------------------------------------|
| Lot 1   | 75 ft.                         | 182 ft.                         | 47.17 ft.                        | 17,115 sq. ft.                        |
| Lot 2   | 90 ft.                         | 251 ft.                         | 98.1 ft. North<br>247.9 ft. East | 33,316 sq. ft.                        |

The majority of the required infrastructure has already been installed. The detention facility has been constructed and meets all requirements of the Village’s Stormwater Ordinance. The petitioner is in the process of installing remaining infrastructure originally approved in 2004. The petitioner will install the remaining seven trees on Lynn Gremer Ct and ten remaining trees along Davane Lane. One street light will be installed in Lynn Gremer Court. The petitioner will continue installation of public sidewalks at the time of construction of single family homes on individual lots.

All required park and school donations were paid by the original developer when the subdivision was approved. No additional payments are required at this time.

The consolidation is consistent with the Comprehensive Plan. The existing neighborhood is a single family residential neighborhood. The proposed resubdivision will allow for a new single family home which meets the Plan’s goal to ensure quality housing stock remains a staple of the community. The Residential Area Plan section of the Comprehensive Plan recommends residential areas provide a variety of housing and dwelling unit types and densities, generally organized by dwelling types and lot sizes as identified in the Land Use Plan. Additionally, the proposed lot sizes are consistent in width and area with other lots in the R-3 district.

The Plan Commission considered the petition at their March 5, 2012 meeting. One resident expressed concern the one additional home on the cul-de-sac would have a negative impact by increasing the density on Lynn Gremer Court. The Plan Commission determined the additional home is consistent with the original approval and the net impact was minimal.

The Commission found that the request met the standards of the Subdivision and Zoning Ordinances. Based on their findings, the Plan Commission recommended unanimous approval of the Final Plat of Subdivision. Staff concurs with the Plan Commission recommendation.

**ATTACHMENTS**

Aerial Map

Resolution

Staff Report with attachments dated March 5, 2012

Minutes of the Plan Commission Hearing dated March 5, 2012

**RESOLUTION \_\_\_\_\_**

**A RESOLUTION APPROVING THE FINAL PLAT FIRST RESUBDIVISION  
OF GREEN ACRES OF DOWNERS GROVE SUBDIVISION  
(401-403 LYNN GREMER COURT AND 6568 FAIRVIEW AVENUE)**

WHEREAS, application has been made pursuant to the provisions of Chapter 20 of the Downers Grove Municipal Code for the approval of the Final Plat of Subdivision to resubdivide three parcels into two lots for First Resubdivision of Green Acres of Downers Grove Subdivision, located at the southwest corner of Fairview Avenue and Lynn Gremer Court, commonly known as 401-03 Lynn Gremer Court and 6568 Fairview Avenue, Downers Grove, Illinois, legally described as follows:

Lots 12, 13, and 14 in Green Acres of Downers Grove Subdivision, being a subdivision in the northeast quarter of Section 20, Township 38 North, Range 11 East of the Third Principal Meridian, according to the plat thereof recorded June 1, 2004 as Document R2004-144920 and certificates of correction recorded May 27, 2005 as Document R2005-110474 and recorded February 2, 2006 as Document R2006-021295, in DuPage County, Illinois.

Commonly known as 403 and 401 Lynn Gremer Court and 6568 Fairview Avenue, Downers Grove, IL 60515 (PIN #'s 09-20-213-017, -018, -019)

WHEREAS, notice has been given and a public hearing held on March 5, 2012 regarding this plat application pursuant to the requirements of the Downers Grove Municipal Code; and,

WHEREAS, the Plan Commission has recommended approval of the Final Plat of Subdivision for the First Resubdivision of Green Acres of Downers Grove Subdivision, located at 401-403 Lynn Gremer Court and 6568 Fairview Avenue, as requested, subject to certain conditions.

NOW, THEREFORE, BE IT RESOLVED by the Village Council of the Village of Downers Grove that the Final Plat of Subdivision for the First Resubdivision of Green Acres of Downers Grove Subdivision, located at 401-403 Lynn Gremer Court and 6568 Fairview Avenue, be and is hereby approved subject to the following condition:

1. The final plat of subdivision shall substantially conform to Final Plat of First Resubdivision of Green Acres of Downers Grove Subdivision prepared by C. M. Lavoie & Associates. Inc., dated December 12, 2011, last revised February 7, 2012 except as such plat may be modified to conform to the Village Codes and Ordinances.
2. The Home Owners Association Declaration of Restrictive Covenants document for the subdivision shall be recorded with the plat of resubdivision.
3. Water service stubs for Lots 13 and 14 shall be disconnected at the main prior to issuance of the certificate of occupancy for Lot One.
4. Upon completion of all remaining public improvements for the entire Green Acres Subdivision, the petitioner shall submit record drawings for approval by the Village Council. Along with the record drawings, the petitioner shall submit a guarantee security in the amount of 20% of the total cost of the

public improvements, which shall expire no earlier than two years after acceptance of such public improvements by the Village Council.

BE IT FURTHER RESOLVED, that the Mayor and Village Clerk are authorized to sign the final plat.

BE IT FURTHER RESOLVED, that this resolution shall be in full force and effect from and after its adoption in the manner provided by law.

\_\_\_\_\_  
Mayor

Passed:

Attest: \_\_\_\_\_  
Village Clerk

# FINAL PLAT FIRST RESUBDIVISION OF GREEN ACRES OF DOWNERS GROVE SUBDIVISION

BEING A SUBDIVISION OF PART OF THE NORTHEAST QUARTER  
OF SECTION 20, TOWNSHIP 38 NORTH, RANGE 11 EAST OF THE  
THIRD PRINCIPAL MERIDIAN, IN DuPAGE COUNTY, ILLINOIS

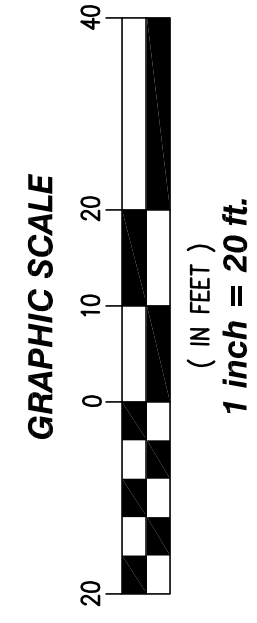

**LEGEND**

- 0.00' MEASURED & RECORDED DATA
- LIMIT OF SURVEY
- PROPOSED LOT LINE
- EXISTING LOT LINE
- SECTION LINE
- EXISTING RIGHT-OF-WAY LINE
- EXISTING EASEMENT LINE
- EXISTING SETBACK LINE
- PROPOSED EASEMENT LINE (HEREBY GRANTED)
- EXISTING EASEMENT LINE (HEREBY ABROGATED)
- EXISTING SETBACK LINE (HEREBY ABROGATED)
- SET 5/8" DIAMETER x 24" LENGTH FROM ROD AT CORNER
- SET 4" SQUARE x 24" LENGTH CONCRETE MONUMENT AT CORNER
- U&D UTILITY AND DRAINAGE EASEMENT
- RECORD LOT TO BE RE-SUBDIVIDED
- L1 N 44°54'37" E, 7.07'
- L2 S 44°54'37" W, 7.06'

\*NOTE: ALL U&D AND STORMWATER MANAGEMENT EASEMENTS WITHIN THIS SUBDIVISION ARE SUBJECT TO THE RULES AND REGULATIONS AS OUTLINED IN THE U&D AND STORMWATER MANAGEMENT CERTIFICATE AND RESUBDIVISION COMPLETION CONDITIONS, AND RESUBDIVISION FOR THE FIRST RESUBDIVISION OF GREEN ACRES OF DOWNERS GROVE SUBDIVISION.

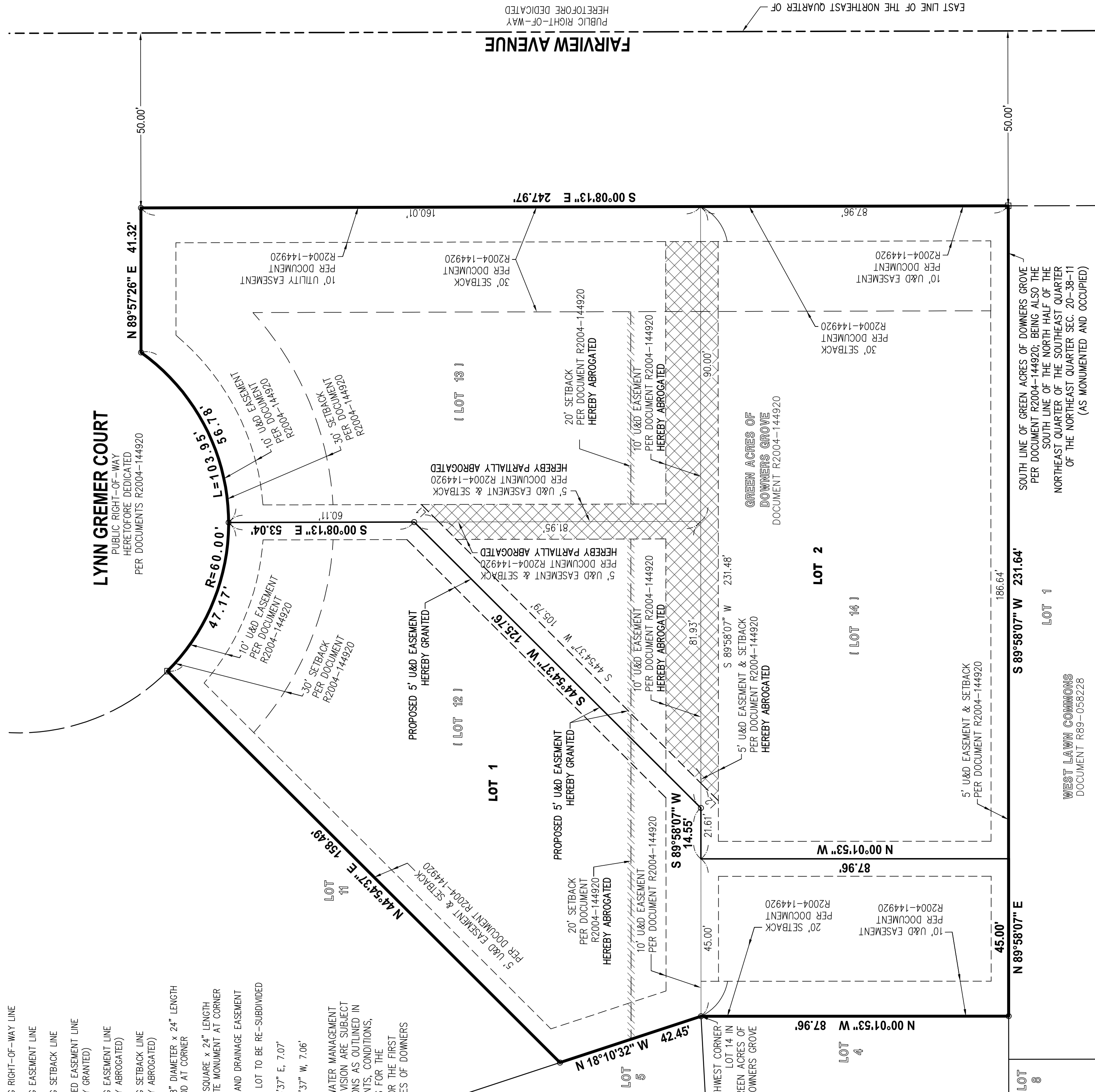

**SETBACK LINE OVER LOT 12**  
**IN GREEN ACRES OF DOWNERS GROVE SUBDIVISION**  
HEREBY ABROGATED AS FOLLOWS

20 FOOT REAR SETBACK LINE FOR LOT 12 IN GREEN ACRES OF DOWNERS GROVE SUBDIVISION PER DOCUMENT R2004-144920.

**U&D EASEMENT OVER LOT 12**  
**IN GREEN ACRES OF DOWNERS GROVE SUBDIVISION**  
HEREBY ABROGATED AS FOLLOWS

THAT PART OF THE SOUTH 10 FEET OF LOT 12 IN GREEN ACRES OF DOWNERS GROVE SUBDIVISION PER DOCUMENT R2004-144920, LYING EAST OF THE FOLLOWING DESCRIBED LINE:

COMMENCING AT THE NORTHEAST CORNER OF SAID LOT 12, THENCE SOUTH 00 DEGREES 08 MINUTES 13 SECONDS EAST, A DISTANCE OF 60.1 FEET; THENCE SOUTH 44 DEGREES 54 MINUTES 37 SECONDS WEST, A DISTANCE OF 105.79 FEET TO A POINT ON THE SOUTH LINE OF SAID LOT 12, SAID POINT BEING THE POINT OF TERMINATION OF THIS LINE.

AND ALSO THAT PART OF THE EAST 5 FEET OF LOT 12 IN GREEN ACRES OF DOWNERS GROVE SUBDIVISION PER DOCUMENT R2004-144920, LYING SOUTH OF THE FOLLOWING DESCRIBED LINE:

COMMENCING AT THE NORTHEAST CORNER OF SAID LOT 12, THENCE SOUTH 00 DEGREES 08 MINUTES 13 SECONDS EAST, A DISTANCE OF 60.1 FEET; THENCE SOUTH 44 DEGREES 54 MINUTES 37 SECONDS WEST, A DISTANCE OF 105.79 FEET TO A POINT ON THE SOUTH LINE OF SAID LOT 12, SAID POINT BEING THE POINT OF TERMINATION OF THIS LINE.

**SETBACK LINE OVER LOT 13**  
**IN GREEN ACRES OF DOWNERS GROVE SUBDIVISION**  
HEREBY ABROGATED AS FOLLOWS

20 FOOT REAR SETBACK LINE FOR LOT 13 IN GREEN ACRES OF DOWNERS GROVE SUBDIVISION PER DOCUMENT R2004-144920.

**U&D EASEMENT OVER LOT 13**  
**IN GREEN ACRES OF DOWNERS GROVE SUBDIVISION**  
HEREBY ABROGATED AS FOLLOWS

THE SOUTH 10 FEET (EXCEPT THE EAST 10 FEET THEREOF) OF LOT 13 IN GREEN ACRES OF DOWNERS GROVE SUBDIVISION PER DOCUMENT R2004-144920

AND ALSO THAT PART OF THE WEST 5 FEET OF LOT 13 IN GREEN ACRES OF DOWNERS GROVE SUBDIVISION PER DOCUMENT R2004-144920, LYING SOUTH OF THE FOLLOWING DESCRIBED LINE:

COMMENCING AT THE NORTHWEST CORNER OF SAID LOT 13, THENCE SOUTH 00 DEGREES 08 MINUTES 13 SECONDS EAST, A DISTANCE OF 60.1 FEET FOR A POINT OF BEGINNING; THENCE NORTH 44 DEGREES 54 MINUTES 37 SECONDS EAST, A DISTANCE OF 7.07 FEET FOR A POINT OF TERMINATION OF THIS LINE.

**SETBACK LINE OVER LOT 14**  
**IN GREEN ACRES OF DOWNERS GROVE SUBDIVISION**  
HEREBY ABROGATED AS FOLLOWS

20 FOOT REAR SETBACK LINE FOR LOT 14 IN GREEN ACRES OF DOWNERS GROVE SUBDIVISION PER DOCUMENT R2004-144920, LYING EAST OF THE FOLLOWING DESCRIBED LINE:

COMMENCING AT THE NORTHWEST CORNER OF SAID LOT 14, THENCE NORTH 89 DEGREES 58 MINUTES 07 SECONDS EAST, A DISTANCE OF 66.61 FEET FOR A POINT OF BEGINNING; THENCE SOUTH 44 DEGREES 54 MINUTES 37 SECONDS WEST, A DISTANCE OF 7.06 FEET FOR A POINT OF TERMINATION OF THIS LINE.

**U&D EASEMENT AND SETBACK LINE OVER LOT 14**  
**IN GREEN ACRES OF DOWNERS GROVE SUBDIVISION**  
HEREBY ABROGATED AS FOLLOWS

THAT PART OF THE NORTH 5 FEET OF LOT 14 IN GREEN ACRES OF DOWNERS GROVE SUBDIVISION PER DOCUMENT R2004-144920, LYING EAST OF THE FOLLOWING DESCRIBED LINE:

COMMENCING AT THE NORTHWEST CORNER OF SAID LOT 14, THENCE NORTH 89 DEGREES 58 MINUTES 07 SECONDS EAST, A DISTANCE OF 66.61 FEET FOR A POINT OF BEGINNING; THENCE SOUTH 44 DEGREES 54 MINUTES 37 SECONDS WEST, A DISTANCE OF 7.06 FEET FOR A POINT OF TERMINATION OF THIS LINE.

**DOWNERS GROVE VILLAGE ENGINEERS CERTIFICATE**  
**(FOR ABROGATION OF EASEMENT)**

ABROGATION OF THE EASEMENTS DESIGNATED TO BE ABROGATED HEREON APPROVED AND ACCEPTED THIS \_\_\_\_\_ DAY OF \_\_\_\_\_ 2012.

BY: \_\_\_\_\_ TITLE: \_\_\_\_\_

**DOWNERS GROVE PUBLIC WORKS CERTIFICATE**  
**(FOR ABROGATION OF EASEMENT)**

ABROGATION OF THE EASEMENTS DESIGNATED TO BE ABROGATED HEREON APPROVED AND ACCEPTED THIS \_\_\_\_\_ DAY OF \_\_\_\_\_ 2012.

BY: \_\_\_\_\_ TITLE: \_\_\_\_\_

**DOWNERS GROVE SANITARY DISTRICT CERTIFICATE**  
**(FOR ABROGATION OF EASEMENT)**

ABROGATION OF THE EASEMENTS DESIGNATED TO BE ABROGATED HEREON APPROVED AND ACCEPTED THIS \_\_\_\_\_ DAY OF \_\_\_\_\_ 2012.

BY: \_\_\_\_\_ TITLE: \_\_\_\_\_

**DOWNERS GROVE VILLAGE COUNCIL'S CERTIFICATE**  
**(FOR ABROGATION OF EASEMENT)**

ABROGATION OF THE EASEMENTS DESIGNATED TO BE ABROGATED HEREON APPROVED AND ACCEPTED THIS \_\_\_\_\_ DAY OF \_\_\_\_\_ 2012.

MAYOR: \_\_\_\_\_ VILLAGE CLERK: \_\_\_\_\_

**COMCAST'S CERTIFICATE**  
**(FOR ABROGATION OF EASEMENT)**

ABROGATION OF THE EASEMENTS DESIGNATED TO BE ABROGATED HEREON APPROVED AND ACCEPTED THIS \_\_\_\_\_ DAY OF \_\_\_\_\_ 2012.

BY: \_\_\_\_\_ TITLE: \_\_\_\_\_

**NICORS CERTIFICATE**  
**(FOR ABROGATION OF EASEMENT)**

ABROGATION OF THE EASEMENTS DESIGNATED TO BE ABROGATED HEREON APPROVED AND ACCEPTED THIS \_\_\_\_\_ DAY OF \_\_\_\_\_ 2012.

BY: \_\_\_\_\_ TITLE: \_\_\_\_\_

**COMED'S CERTIFICATE**  
**(FOR ABROGATION OF EASEMENT)**

ABROGATION OF THE EASEMENTS DESIGNATED TO BE ABROGATED HEREON APPROVED AND ACCEPTED THIS \_\_\_\_\_ DAY OF \_\_\_\_\_ 2012.

BY: \_\_\_\_\_ TITLE: \_\_\_\_\_

**AT&T'S CERTIFICATE**  
**(FOR ABROGATION OF EASEMENT)**

ABROGATION OF THE EASEMENTS DESIGNATED TO BE ABROGATED HEREON APPROVED AND ACCEPTED THIS \_\_\_\_\_ DAY OF \_\_\_\_\_ 2012.

BY: \_\_\_\_\_ TITLE: \_\_\_\_\_

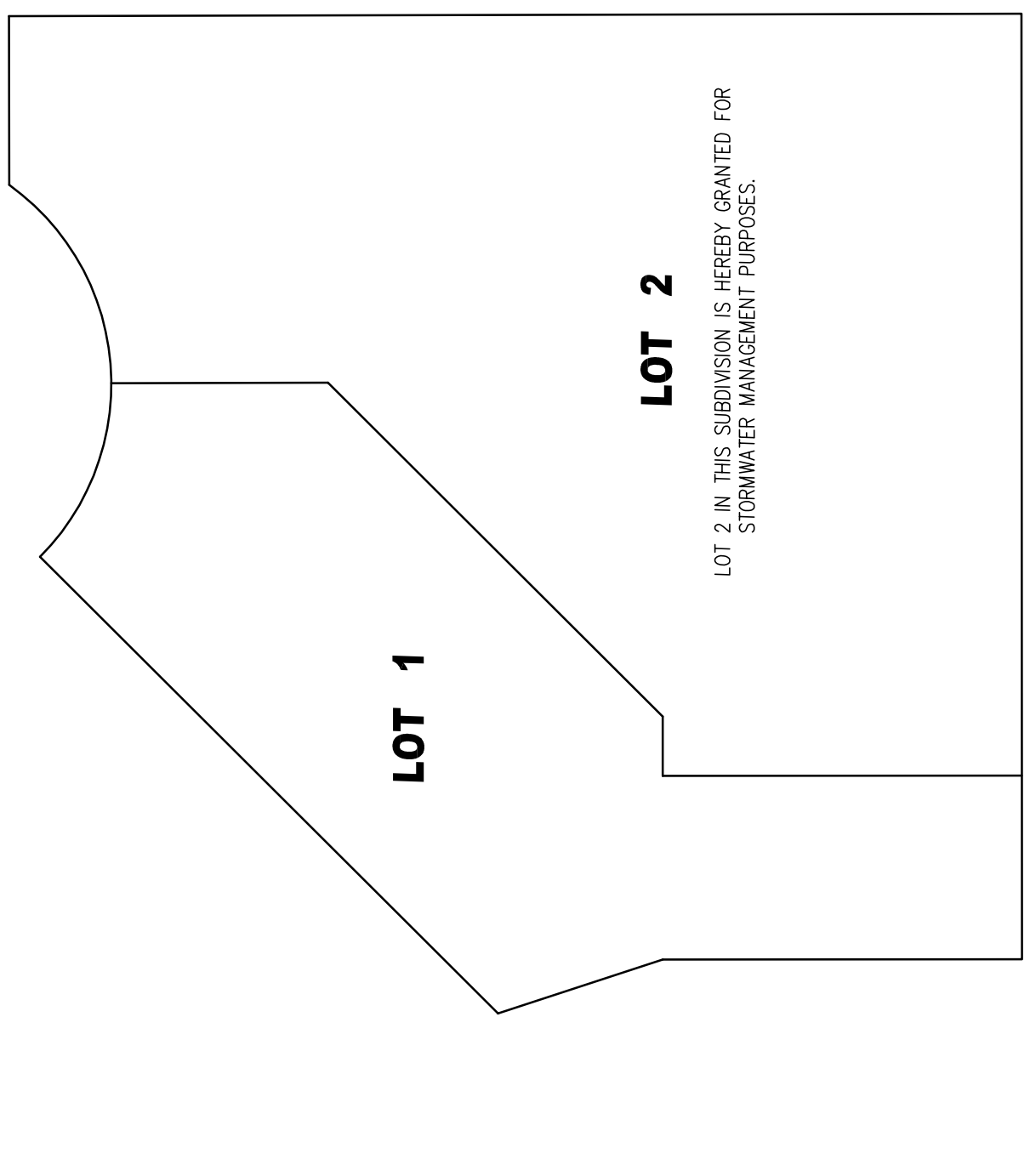

**LOT AREA**  
LOT 1 ~ 17.115 SQUARE FEET OR 0.393 ACRES +/-  
LOT 2 ~ 33.316 SQUARE FEET OR 0.765 ACRES +/-

**SURVEYOR'S NOTES**

1. DIMENSIONS SHOWN THUS: 50.25' ARE FEET AND DECIMAL PARTS THEREOF. ANGULAR DATA SHOWN THUS: 90°00'00" INDICATES DEGREES, MINUTES AND SECONDS.
2. A BLANKET EASEMENT FOR STORMWATER MANAGEMENT WAS GRANTED OVER ALL OF LOTS 12, 13 AND 14 IN GREEN ACRES OF DOWNERS GROVE SUBDIVISION IS HEREBY VACATED PER THIS DOCUMENT.
3. A BLANKET EASEMENT IS HEREBY GRANTED OVER ALL OF LOT 2 IN THIS SUBDIVISION FOR STORMWATER MANAGEMENT PURPOSES.

**GREENSCAPE HOMES, LLC**  
FAIRVIEW AVENUE & LYNN GREMER COURT  
DOWNERS GROVE, ILLINOIS

**PLAT OF RESUBDIVISION**

DRAWN BY: TOB CHECKED BY: KEB  
SCALE: 1"=20' DATE: 12/19/11  
JOB NUMBER: 11-157 SHEET: 1 OF 2

| # | DATE    | DESCRIPTION                      |
|---|---------|----------------------------------|
| 1 | 1/7/12  | REV. PER VILLAGE LIR DTD. 1/1/12 |
| 2 | 2/07/12 | REV. PER VILLAGE LIR DTD. 2/3/12 |
| 3 |         |                                  |
| 4 |         |                                  |
| 5 |         |                                  |
| 6 |         |                                  |
| 7 |         |                                  |
| 8 |         |                                  |

C.M. Lavoie & Associates, Inc.  
Consulting Civil Engineering  
Land Planning & Surveying  
1050 State Route 126  
Plainfield, Illinois 60544  
voice 815-254-0905  
for 815-436-5158

© Copyright, 2012, C.M. Lavoie & Associates, Inc.  
This plan is protected under the copyright laws of the United States of America and foreign countries, and is to be used solely at the discretion of the Owner and C.M. Lavoie & Associates, Inc. Any use of this plan without the permission of the Owner and/or C.M. Lavoie & Associates, Inc., constitutes a violation of C.M. Lavoie & Associates, Inc.'s copyright of this plan and is prohibited.



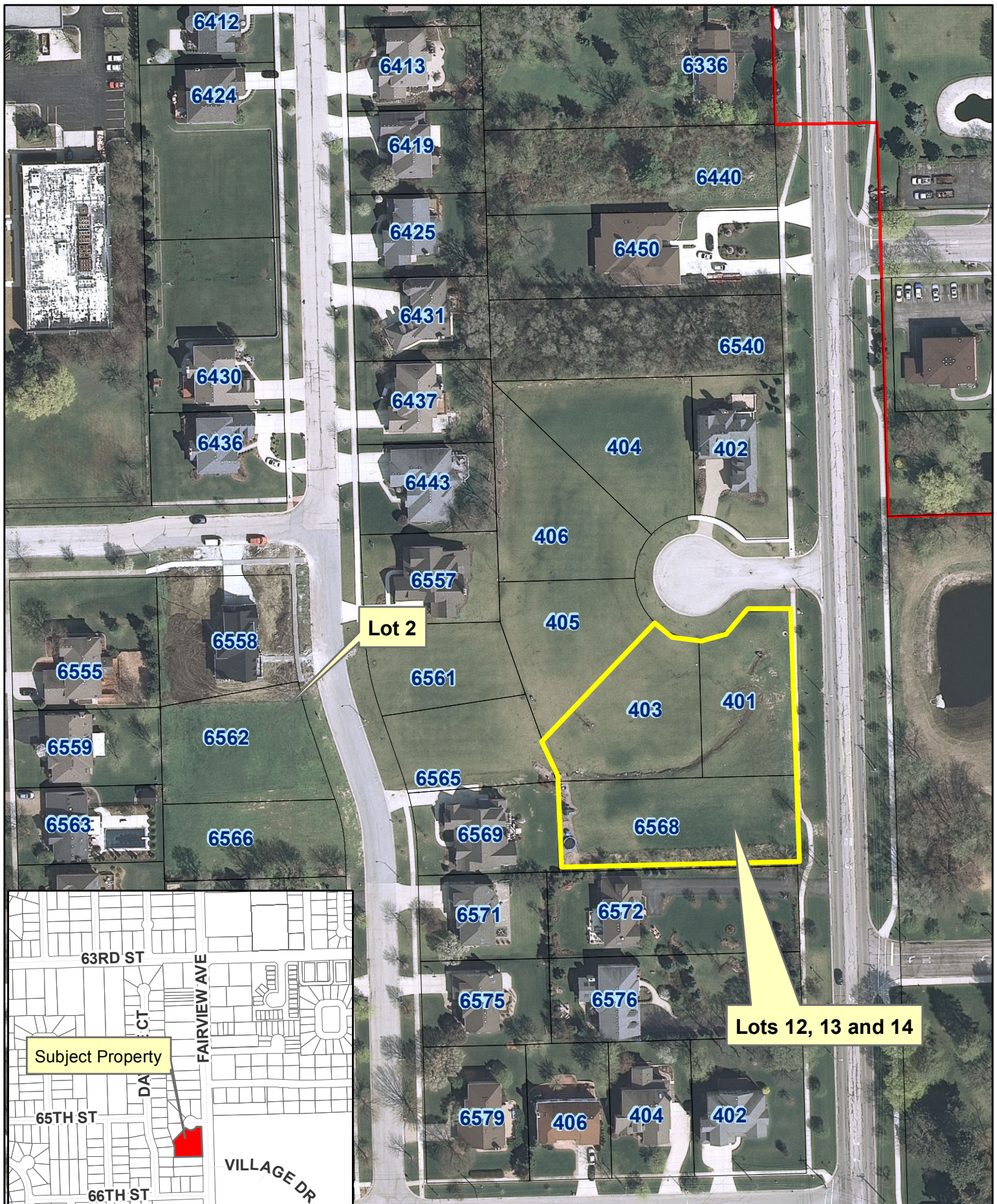

**Green Acres Re-subdivision  
403 and 401 Lynn Gremer Court &  
6568 Fairview Avenue**





**VILLAGE OF DOWNERS GROVE  
REPORT FOR THE PLAN COMMISSION  
MARCH 5, 2012 AGENDA**

| <b>SUBJECT:</b>   | <b>TYPE:</b>              | <b>SUBMITTED BY:</b>             |
|---|---------------------------|----------------------------------|
| PC-06-12<br>401-403 Lynn Gremer Court and<br>6568 Fairview Avenue | Final Plat of Subdivision | Damir Latinovic, AICP<br>Planner |

**REQUEST**

The petitioner is requesting approval of a final plat of subdivision to resubdivide three existing lots into two new lots.

**NOTICE**

The application has been filed in conformance with applicable procedural and public notice requirements.

**GENERAL INFORMATION**

---

**OWNER:** Greenscape Homes, LLC.  
4355 Weaver Parkway  
Warrenville, IL 60555

**APPLICANT:** Tim Hejny  
C. M. Lavoie & Associates, Inc.  
1050 West Route 126  
Plainfield, IL 60544

**PROPERTY INFORMATION**

---

**EXISTING ZONING:** R-3, Single Family Residential  
**EXISTING LAND USE:** Vacant  
**PROPERTY SIZE:** 1.15 acres (50,431 sq. ft.)  
**PINS:** 09-20-213-017, -018, -019

**SURROUNDING ZONING AND LAND USES**

**ZONING**

**NORTH:** R-3, Single Family Residence  
**SOUTH:** R-3, Single Family Residence  
**EAST:** R-5A, Townhouse Residence & PD #32  
**WEST:** R-3, Single Family Residence

**FUTURE LAND USE**

Single Family Residential  
Single Family Residential  
Multi-Family Residential  
Single Family Residential

**ANALYSIS**

---

**SUBMITTALS**

This report is based on the following documents, which are on file with the Department of Community Development:

1. Application/Petition for Public Hearing
2. Project Narrative
3. Plat of Survey
4. Plat of Subdivision
5. Detention Basin Exhibit

### **PROJECT DESCRIPTION**

The petitioner is requesting approval of a final plat of subdivision to resubdivide three existing lots into two new lots. The three lots are part of the Green Acres Subdivision approved in 2004. The lots have a total area of 50,431 sq. ft. The Green Acres Subdivision, zoned R-3 Single Family Residence, is located on the west side of Fairview Avenue just north of 66<sup>th</sup> Street. The approval of the 14-lot subdivision included extension of Davane Lane and creation of new Lynn Gremer Court. Lots 1-11 were designated for single family homes while lots 12, 13 and 14 located south of Lynn Gremer Court were designated for a stormwater detention facility.

The petitioner modified the detention facility so that it does not take up all of lots 12, 13 and 14. As such, the petitioner is proposing to resubdivide lots 12, 13 and 14 into two new lots. Lot One would become buildable single family residential lot while Lot Two would contain the entire stormwater detention basin.

Since 2004, four homes were completed and three more are currently under construction. The petitioner owns all other vacant lots in the subdivision and plans to construct single family homes on the remaining lots.

### **COMPLIANCE WITH COMPREHENSIVE PLAN**

The existing neighborhood is a single family residential neighborhood. The proposed resubdivision will allow for one more new single family home which meets the Plan's goal to ensure quality housing stock remains a staple of the community. The Residential Area Plan section of the Comprehensive Plan recommends residential areas provide a variety of housing and dwelling unit types and densities, generally organized by dwelling types and lot sizes as identified in the Land Use Plan. Additionally, the proposed lot sizes are consistent in width and area with other lots in the R-3 district. Staff believes the proposed resubdivision to create one more buildable lot is consistent with the Comprehensive Plan.

### **COMPLIANCE WITH ZONING ORDINANCE**

The property is zoned R-3 Single Family Residence District. The property is currently vacant. The two proposed lots comply with Sections 28.1103(c) and 28.1104(c) of the Zoning Ordinance. If the resubdivision is approved, the petitioner will be able to construct one additional single family home. The new home will meet all Zoning Ordinance bulk and setback requirements.

### **COMPLIANCE WITH THE SUBDIVISION ORDINANCE**

The two proposed lots will meet the minimum lot dimension requirements for the R-3 zoning district and per Section 20.301 of the Subdivision Ordinance. The lot dimensions are specified in the table below:

| 401-403<br>Lynn<br>Gremer Ct<br>& 6568<br>Fairview<br>Ave | Lot Width |          | Lot Depth |          | Frontage |                                      | Lot Area          |                   |
|---|-----------|----------|-----------|----------|----------|--------------------------------------|-------------------|-------------------|
|   | Required  | Proposed | Required  | Proposed | Required | Proposed                             | Required          | Proposed          |
| Lot 1   | 75 ft     | 75 ft    | 140 ft    | 182 ft   | 45 ft    | 47.17 ft                             | 10,500<br>sq. ft. | 17,115<br>sq. ft. |
| Lot 2   | 75 ft     | 90 ft    | 140 ft    | 251 ft   | 45 ft    | 98.1 ft<br>North<br>247.9 ft<br>East | 10,500<br>sq. ft. | 33,316<br>sq. ft. |

The petitioner has not requested any exceptions from the Subdivision Ordinance. The required five-foot wide public utility and drainage easements will be provided along the new side lot lines. A new blanket stormwater detention easement will be placed over the entire Lot Two designated for the stormwater detention area. All other required public utility and drainage easements already exist and adequately serve the subdivision.

All required park and school donations were paid by the developer when the original subdivision was approved. No additional payments are required at this time.

**ENGINEERING/PUBLIC IMPROVEMENTS**

The petitioner is in the process of finalizing the construction of all required stormwater facilities for the entire Green Acres subdivision. The stormwater detention facility was originally planned for lots 12, 13 and 14. The petitioner modified the shape of the detention to create one more buildable lot. The detention facility would be entirely located on the proposed Lot Two, while the proposed Lot One is designated as a buildable lot. The detention facility meets all requirements of the Village’s Stormwater Ordinance. The petitioner will create a home-owners association which will be responsible for maintenance of the detention facility.

The majority of the required infrastructure has already been installed. The petitioner is in the process of installing remaining infrastructure items originally approved in 2004. The petitioner will install the remaining seven trees on Lynn Gremer Ct and ten remaining trees along Davane Lane. One street light will be installed in Lynn Gremer Court. The petitioner will continue installation of public sidewalks at the time of construction of single family homes on individual lots. The petitioner will install the final layer of asphalt on Lynn Gremer Court upon completion of all single family homes on the cul-de-sac.

**NEIGHBORHOOD COMMENT**

Notice was provided to all property owners within 250 feet of the entire property. In addition, the notice was posted on the site and published in the Downers Grove Reporter. Staff has not received any neighborhood comment regarding the proposal at this time.

**FINDINGS OF FACT**

Staff believes the proposed Final Plat of Subdivision to consolidate the three existing lots into two new lots meets the standards of Sections 28.1103(c) and 28.1104(c) of the Zoning Ordinance and Sections 20.101 and 20.301(b) of the Subdivision Ordinance. Staff believes the request is consistent with the Comprehensive Plan and Zoning and Subdivision Ordinances of the Village.

## RECOMMENDATIONS

---

The proposed final plat of subdivision is compatible with the surrounding zoning and land use classifications. Based on the findings listed above, staff recommends that the Plan Commission make a motion recommending approval of the final plat of subdivision associated with PC-06-12 to the Village Council subject to the following conditions:

1. The final plat of subdivision shall substantially conform to Final Plat of First Resubdivision of Green Acres of Downers Grove Subdivision prepared by C. M. Lavoie & Associates. Inc., dated December 12, 2011, last revised February 7, 2012 except as such plat may be modified to conform to the Village Codes and Ordinances.
2. The Home Owners Association Declaration of Restrictive Covenants document for the subdivision shall be recorded with the plat of resubdivision.
3. Water service stubs for Lots 13 and 14 shall be disconnect at the main prior to issuance of the certificate of occupancy for Lot One.
4. Upon completion of all remaining public improvements for the entire Green Acres Subdivision, the petitioner shall submit record drawings for approval by the Village Council. Along with the record drawings, the petitioner shall submit a guarantee security in the amount of 20% of the total cost of the public improvements, which shall expire no earlier than two years after acceptance of such public improvements by the Village Council.

Staff Report Approved By:

---

Tom Dabareiner, AICP  
Director of Community Development

TD:dl  
-att

P:\P&CD\PROJECTS\PLAN COMMISSION\2012 PC Petition Files\PC 06-12 Green Acres Resubdivision\Staff Report PC-36-12.doc

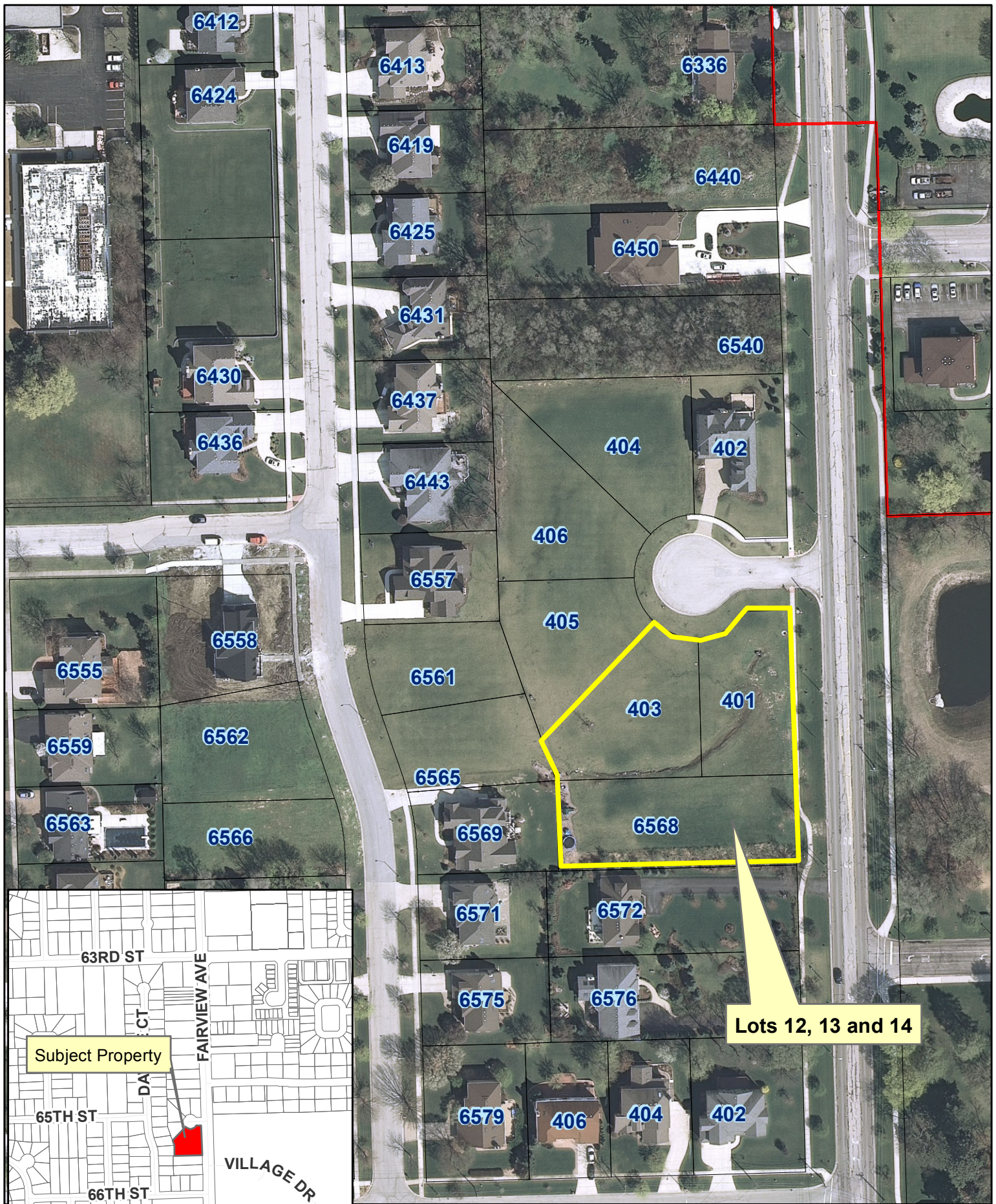

Lots 12, 13 and 14

**Green Acres Re-subdivision  
403 and 401 Lynn Gremer Court &  
6568 Fairview Avenue**



**GREENSCAPE  
HOMES, LLC**

December 16, 2011

Mr. Jeff O'Brien  
Village of Downers Grove  
Department of Community Development  
801 Burlington Avenue  
Downers Grove, IL 60515

Dear Mr. O'Brien:

Subject: Authorization for Owner's designated agent – Greenscape Homes

Please accept this letter of authorization appointing CM Lavoie & Associates to act as Greenscape Homes' designated agent for the subdivision process for the Village of Downers Grove for the following property:

Property Located at Fairview Avenue and Lynn Gremer Court  
PIN(s) #09-20-213-017; 09-20-213-018, 09-20-213-019

If you have any questions or need additional information, please don't hesitate to contact me at 630/281-2039.

Sincerely,

Kathleen Washko  
Chief Financial Officer

cc: Ken Neumann



**C. M. Lavoie & Associates, Inc.**

**Consulting Civil Engineering  
Land Planning & Surveying**

1050 State Route 126 • Plainfield, IL 60544  
815.254.0505 • Fax: 815.436.5158

December 13, 2011

Village of Downers Grove  
Department of Community Development  
801 Burlington Avenue  
Downers Grove, Illinois 60515  
Attn: Jeff O'Brien, Planning Manager

RE: Green Acres of Downers Grove  
Fairview Avenue at 65<sup>th</sup> Street

Dear Mr. O'Brien,

On behalf of Greenscape Ventures, LLC, C.M. Lavoie & Associates, Inc. is pleased to submit 6 copies of the *Final Plat for the First Resubdivision of Green Acres of Downers Grove*. We would like to resubdivide Lots 12, 13 and 14 of the existing subdivision into 2 lots, one of which will be a single family residential lot with the same zoning and the other being a lot solely for stormwater management purposes. In addition to subdividing the existing lots, we would also like to vacate a blanket stormwater management easement that was granted for lots 12, 13 and 14.

We request to be put on the earliest available Plan Commission agenda.

If you have any questions, please do not hesitate to contact our office.

Sincerely yours,

C.M. Lavoie & Associates, Inc.

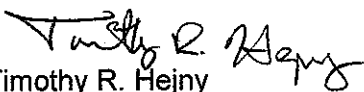
  
Timothy R. Hejny  
Project Manager

cc: Ken Neumann – Greenscape Ventures, LLC

Q:\2011 Projects\11-157\Correspondence to\North\11-1213 ltr to Village (resub plat submittal).docx



## **C. M. Lavoie & Associates, Inc.**

**Consulting Civil Engineering  
Land Planning & Surveying**

1050 State Route 126 • Plainfield, IL 60544  
815.254.0505 • Fax: 815.436.5158

December 16, 2011

### **FIRST RESUBDIVISION OF GREEN ACRES OF DOWNERS GROVE PROJECT SUMMARY**

The proposed First Resubdivision of Green Acres of Downers Grove consists of Lots 12, 13 and 14 of Green Acres of Downers Grove Subdivision which was recorded June 1, 2004 (Document Number R2004-144920). As part of the Green Acres of Downers Grove Subdivision, calculations were prepared to provide stormwater detention for the proposed subdivision at an off-site location. Roadway, watermain, sanitary and storm sewer were installed in the proposed subdivision as permitted. The off-site stormwater detention was not constructed. Four of the fourteen lots had single family houses constructed on them.

Since these homes were constructed, the remaining lots have changed ownership. The current owner/developer wishes to continue construction of homes on the remaining lots. Prior to constructing any homes in the subdivision, the developer is required by the Village of Downers Grove to construct a stormwater detention system. The developer has begun construction of a detention pond (please see drawing *EX-03 – Detention Basin Exhibit* by C.M. Lavoie & Associates, Inc. for construction drawing of the proposed detention pond) which is located on portions of lots 12 and 13 and all of lot 14.

The purpose of the First Resubdivision of Green Acres of Downers Grove is to resubdivide lots 12, 13 and 14 into two separate lots. Lot One will be a single family residential lot and Lot 2 will be used exclusively for stormwater management purposes.

Lot One conforms to all of the Village of Downers Grove zoning requirements for R-3 zoning including square footage, width, depth and setbacks as stipulated in the current Zoning Ordinance.

In addition to resubdividing Lots 12, 13 and 14, we are requesting that the existing Conservation Easement located on Lot 2 of the Green Acres of Downers Grove to be abrogated. The Conservation Easement was originally granted to the Lot to conserve the existing wetland. The wetlands have since been removed, resulting in no longer needing the easement.



# ALTA/ACSM LAND TITLE SURVEY

OF  
PART OF SECTION 20, TOWNSHIP 38 NORTH, RANGE 11 EAST OF  
THE THIRD PRINCIPAL MERIDIAN, IN DUPAGE COUNTY, ILLINOIS.

## TITLE COMMITMENT INFORMATION

REFERENCE: COMMITMENT FOR TITLE INSURANCE PREPARED BY FIRST AMERICAN TITLE INSURANCE COMPANY, ORDER NO.: 2193946

| TITLE COMMITMENT REFERENCE NUMBER (SCHEDULE B) | RECORDING REFERENCE | DESCRIPTION  | STATUS ON PLAT    |
|--|---------------------|--|-------------------|
| EXCEPTION 42                                   | R2004-144920        | BUILDING LINES AND UTILITY/DRAINAGE EASEMENTS AS CONTAINED IN THE PLAT OF SUBDIVISION AND CERTIFICATE OF CORRECTIONS | AS SHOWN          |
| EXCEPTION 43                                   | R2004-144920        | UTILITY EASEMENTS AS SHOWN ON THE PLAT OF SUBDIVISION  | AS SHOWN          |
| EXCEPTION 44                                   | R2004-144920        | EASEMENT FOR STORMWATER MANAGEMENT OVER ALL OF LOTS 12, 13 AND 14.   | BLANKET IN NATURE |
| EXCEPTION 45                                   | R2004-144920        | CONSERVATION EASEMENT AS CONTAINED IN THE PLAT OF SUBDIVISION AND CERTIFICATE OF CORRECTIONS OVER ALL OF LOT 2.      | BLANKET IN NATURE |

SCHEDULE B ITEMS 1, 2, 3, 4, 5, 6, 7, 8, 9, 10, 11, 12, 13, 14, 15, 16, 17, 18, 19, 20, 21, 22, 23, 24, 25, 26, 27, 28, 29, 30, 31, 32, 33, 34, 35, 36, 37, 38, 39, 40, 41 and 46 REFER TO ITEMS SUCH AS TAXES, MORTGAGES, LEASES, DOCUMENT RECORDING REQUIREMENTS, SIMILAR TITLE INSURANCE CONCERNS WHICH ARE NOT MATTERS OF SURVEY AND OTHER LAND MATTERS NOT AFFECTED BY THIS SURVEY. THE SURVEYOR HAS NOT EXAMINED OR ADDRESSED THESE ITEMS AND MAKES NO STATEMENT CONCERNING THEM.

THIS SURVEY DOES NOT CONSTITUTE AN INDEPENDENT TITLE SEARCH BY THE SURVEYOR. ALL INFORMATION SHOWN REGARDING RECORD EASEMENTS, AGREEMENTS AND OTHER DOCUMENTS WHICH MIGHT AFFECT THE QUALITY OF TITLE TO THE SUBJECT PROPERTY WAS GAINED FROM THE ABOVE REFERENCED TITLE COMMITMENT.

## LEGEND

|                                   |         |                                    |
|-----------------------------------|---------|------------------------------------|
| ● EXISTING MONUMENTATION          | 0.00'   | MEASURED DATA                      |
| ○ SET MONUMENTATION               | (0.00') | RECORD DATA                        |
| ⊗ EXISTING B-BOX                  | —       | LIMIT OF SURVEY                    |
| ○ EXISTING CATCH BASIN            | —       | EXISTING RIGHT-OF-WAY LINE         |
| ○ EXISTING FIRE HYDRANT           | ---     | EXISTING EASEMENT LINE             |
| ◁ EXISTING FLARED END SECTION     | ---     | EXISTING SETBACK LINE              |
| ⊞ EXISTING INLET                  | ---     | EXISTING CONTOUR LINE              |
| ⊞ EXISTING LIGHT STANDARD         | ---     | EXISTING UNDERGROUND SANITARY LINE |
| ⊞ EXISTING MAILBOX                | ---     | EXISTING UNDERGROUND STORM LINE    |
| ⊞ EXISTING POWER POLE             | ---     | EXISTING UNDERGROUND WATER LINE    |
| ⊞ EXISTING SANITARY MANHOLE W/ ID |         |                                    |
| ⊞ EXISTING STORM MANHOLE W/ ID    |         |                                    |
| ⊞ EXISTING TRAFFIC PEDESTAL       |         |                                    |
| ⊞ EXISTING UTILITY PEDESTAL       |         |                                    |
| ⊞ EXISTING VALVE BOX              |         |                                    |
| ⊞ EXISTING VALVE VAULT            |         |                                    |
| ⊞ EXISTING WATER VALVE            |         |                                    |

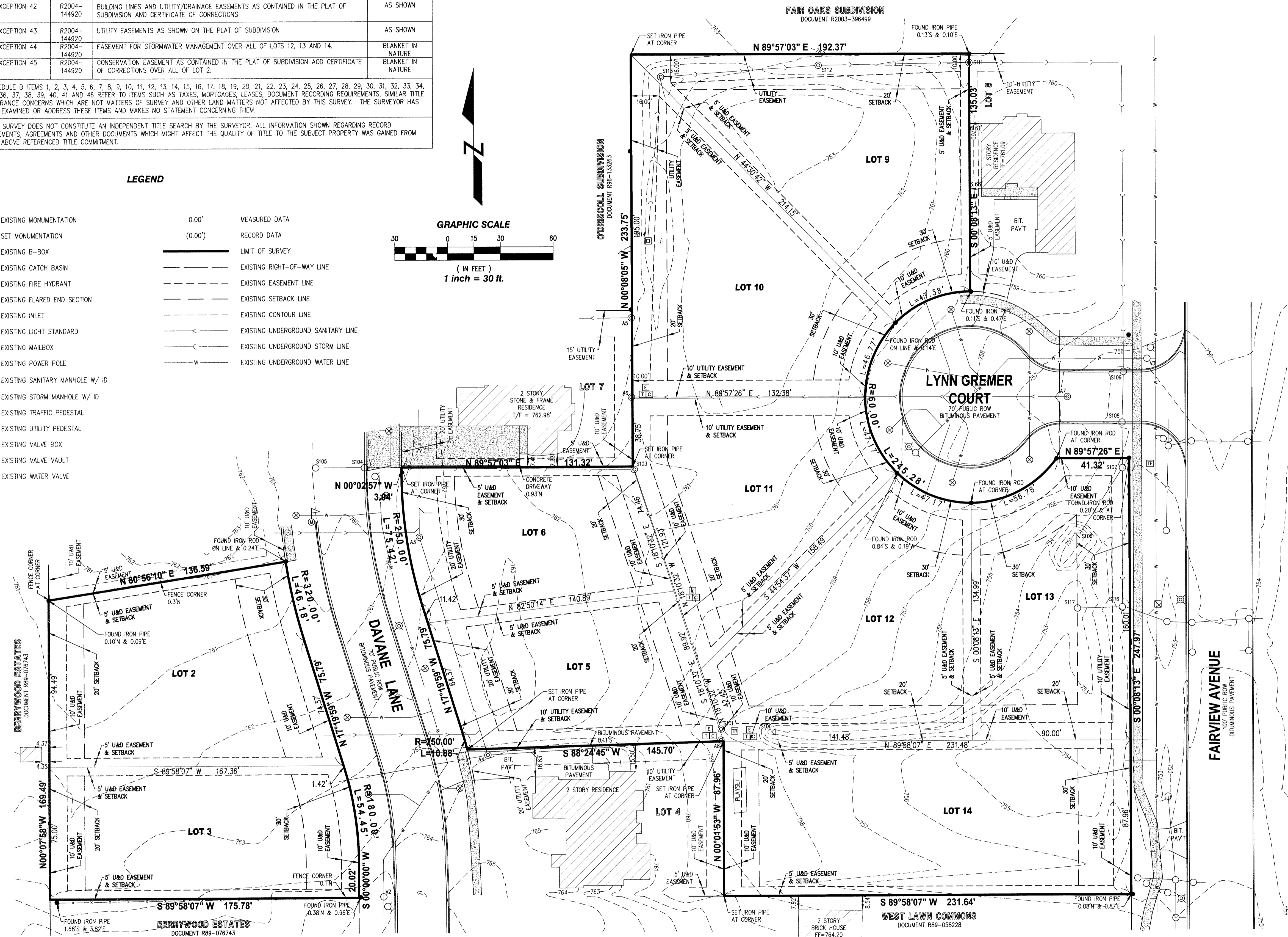
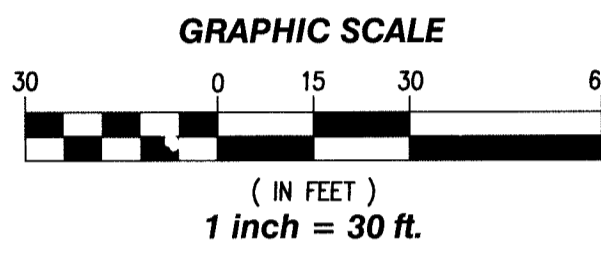

STORM STRUCTURE TABLE

| STR. ID | TYPE       | RIM    | NORTH  | SOUTH  | EAST   | WEST   |
|---------|------------|--------|--------|--------|--------|--------|
| S100    | FES        |        |        |        |        | 753.04 |
| S101    | MH, TYA    | 758.13 | 753.53 |        |        | 753.53 |
| S103    | MH, TYA    | 760.81 |        |        | 754.31 | 754.31 |
| S104    | CB, TYA    | 759.53 |        |        | 754.88 | 754.88 |
| S105    | CB, TYA    | 759.77 |        |        | 755.67 | 755.67 |
| S106    | 18" RCFCES |        |        |        | 749.99 | 749.99 |
| S107    | CB, TYA    | 754.24 | 750.44 |        |        | 750.34 |
| S108    | CB, TYA    | 754.58 | 750.73 | 750.73 |        |        |

STORM STRUCTURE TABLE

| STR. ID | TYPE    | RIM    | NORTH  | SOUTH  | EAST   | WEST   |
|---------|---------|--------|--------|--------|--------|--------|
| S109    | CB, TYA | 754.58 | 750.73 | 750.73 |        |        |
| S111    | MH, TYA | 759.05 |        |        | 753.05 | 753.05 |
| S112    | MH, TYA | 759.90 |        |        | 753.40 | 753.40 |
| S113    | MH, TYA | 759.74 |        |        | 754.24 | 754.24 |
| S114    | MH, TYA | 759.99 |        |        | 749.99 | 749.99 |
| S115    | MH, TYA | 752.50 | 748.30 | 748.30 | 748.55 | 748.55 |
| S116    | CB, TYA | 755.57 | 749.54 |        |        | 749.44 |
| S117    | CB, TYA | 752.42 |        |        |        | 749.49 |

SANITARY STRUCTURE TABLE

| ID | TYPE    | RIM   | NORTH  | SOUTH  | EAST   | WEST   |
|----|---------|-------|--------|--------|--------|--------|
| A3 | MH, TYA | 761.2 | 749.65 | 749.55 |        |        |
| A4 | MH, TYA | 763.8 | 750.10 |        |        | 750.00 |
| A5 | MH, TYA | 762.9 |        |        | 749.40 | 749.50 |
| A6 | MH, TYA | 760.6 | 749.50 |        |        | 749.35 |
| A7 | MH, TYA | 756.2 |        |        |        | 750.70 |
| A8 | MH, TYA | 758.2 |        |        | 750.70 | 750.80 |

| VALVE VAULTS | STRUCTURE ID | SIZE | RIM   |
|--------------|--------------|------|-------|
|              | V2           | 8 IN | 765.4 |
|              | V3           | 8 IN | 755.6 |

## LEGAL DESCRIPTION

LOTS 2, 3, 5, 6, 9, 10, 11, 12, 13 AND 14 IN GREEN ACRES OF DOWNERS GROVE IN THE NORTHEAST QUARTER OF SECTION 20, TOWNSHIP 38 NORTH, RANGE 11 EAST OF THE THIRD PRINCIPAL MERIDIAN, ACCORDING TO THE PLAT THEREOF RECORDED JUNE 1, 2004 AS DOCUMENT R2004-144920 AND CERTIFICATES OF CORRECTION RECORDED MAY 27, 2005 AS DOCUMENT R2005-110474 AND RECORDED FEBRUARY 2, 2006 AS DOCUMENT R2006-021295, IN DUPAGE COUNTY, ILLINOIS

SAID PARCEL OF LAND CONTAINING 150,934 SQUARE FEET OR 3.465 ACRES, MORE OR LESS.

## ADDRESSES

LOT 2 = 6562 DAVANE LANE, DOWNERS GROVE, IL  
LOT 3 = 6566 DAVANE LANE, DOWNERS GROVE, IL  
LOT 5 = 6565 DAVANE LANE, DOWNERS GROVE, IL  
LOT 6 = 6561 DAVANE LANE, DOWNERS GROVE, IL  
LOT 9 = 404 LYNN GREMER COURT, DOWNERS GROVE, IL  
LOT 10 = 406 LYNN GREMER COURT, DOWNERS GROVE, IL  
LOT 11 = 405 LYNN GREMER COURT, DOWNERS GROVE, IL  
LOT 12 = 403 LYNN GREMER COURT, DOWNERS GROVE, IL  
LOT 13 = 401 LYNN GREMER COURT, DOWNERS GROVE, IL  
LOT 14 = 6568 FAIRVIEW AVENUE, DOWNERS GROVE, IL

## BENCHMARKS

DUPAGE COUNTY BENCHMARK:  
DGN07001 - BRONZE DISK IN CONCRETE BASE OF TRAFFIC CONTROL BOX AT THE NORTHWEST CORNER OF MAPLE AVENUE AND 52TH STREET.  
ELEVATION: 743.51' NGVD29

ON-SITE BENCHMARK:  
18 - SET CUT CROSS ON THE SOUTHWESTERLY SIDE OF LYNN GREMER COURT BETWEEN LOTS 11 AND 12 APPROXIMATELY 8.85' S21.1° E OF A LIGHT POLE AND 4.89' NELY OF A FIRE HYDRANT.  
ELEVATION: 758.31' NGVD29

## ZONING NOTE

THE FOLLOWING BULK ZONING REGULATIONS ARE BASED ON THE CURRENT ZONING ORDINANCE OF THE VILLAGE OF DOWNERS GROVE. THE BULK ZONING REGULATIONS LISTED BELOW ARE OUR INTERPRETATION OF THE ABOVE DOCUMENTS TO THE BEST OF OUR ABILITY. ANYONE MAKING DETERMINATIONS AS TO COMPLIANCE WITH APPLICABLE ZONING REGULATIONS SHOULD ALWAYS REFER TO THE ACTUAL DOCUMENTS AS WELL AS SEEK VERIFICATION FROM APPROPRIATE VILLAGE STAFF AND/OR LEGAL COUNCIL.

LOCATION: DAVANE CT., LYNN GREMER CT. AND FAIRVIEW AVENUE

ZONE: R3

## R3 ZONING - AREA REGULATIONS PER VILLAGE DOWNERS GROVE ORDINANCE

SETBACKS:  
FRONT YARD: 30 FEET  
SIDE YARD: 6 FEET OR 10% OF LOT WIDTH, WHICHEVER IS GREATER  
REAR YARD: 20 FEET  
MAXIMUM BUILDING HEIGHT: NOT TO EXCEED 33 FEET  
FLOOR AREA RATIO: NOT TO EXCEED 0.8%

## SURVEYOR'S NOTES

- DIMENSIONS SHOWN THUS: 50.25' ARE FEET AND DECIMAL PARTS THEREOF. ANGULAR DATA SHOWN THUS: 90°00'00" INDICATES DEGREES, MINUTES AND SECONDS.
- NORTH ARROW AND BEARINGS BASED ON THE WEST RIGHT-OF-WAY LINE OF FAIRVIEW AVENUE TO BE NORTH 00 DEGREES 08 MINUTES 13 SECONDS WEST.
- THIS SURVEY WAS PREPARED UTILIZING A COMMITMENT FOR TITLE INSURANCE PREPARED BY FIRST AMERICAN TITLE INSURANCE COMPANY, FILE NUMBER 2193946 WITH AN EFFECTIVE DATE OF JULY 28, 2011.
- COMPARE YOUR POINTS BEFORE USING SAME AND REPORT ANY DIFFERENCES IMMEDIATELY.
- CHECK LEGAL DESCRIPTION WITH DEED OR TITLE POLICY AND REPORT ANY DISCREPANCY IMMEDIATELY. BUILDING LINES AND EASEMENTS, IF ANY, SHOWN HEREON ARE AS SHOWN ON THE RECORDED SUBDIVISION OR AS INDICATED.
- THE LOCATION OF UNDERGROUND UTILITIES SHOWN HEREON ARE APPROXIMATE AND COMPILED FROM FIELD SURFACE OBSERVATIONS, UTILITY MARKINGS LOCATED IN THE FIELD AND UTILITY ATLASSES. SOME OF THE PROVIDED ATLASSES INDICATE LOCATIONS BY GRAPHIC REPRESENTATION ONLY AND THESE ARE SHOWN TO THE BEST OF OUR ABILITY. UNDERGROUND UTILITIES SHOWN ARE FOR INFORMATIONAL PURPOSES ONLY. ANY CONTRACTOR CONTEMPLATING WORK ON THIS SITE SHOULD CONFIRM THE LOCATION OF ALL UTILITIES PRIOR TO THE COMMENCEMENT OF EXCAVATION.
- THE SUBJECT PROPERTY IS SITUATED WITHIN "ZONE X" (AREAS OF MINIMAL FLOODING) AS PER FEMA FLOOD INSURANCE RATE MAPS, MAP NUMBER 17043C 0904H, WITH AN EFFECTIVE DATE OF DECEMBER 16, 2004.
- THERE WAS NO OBSERVABLE EVIDENCE OF THE SUBJECT PROPERTY BEING USED AS A SOLID WASTE DUMP, SUMP OR SANITARY LANDFILL.

STATE OF ILLINOIS )

COUNTY OF KENDALL )

THIS IS TO CERTIFY THAT THIS MAP OR PLAT AND THE SURVEY ON WHICH IT IS BASED WERE MADE IN ACCORDANCE WITH THE 2011 MINIMUM STANDARD DETAIL REQUIREMENTS FOR ALTA/ACSM LAND TITLE SURVEYS, JOINTLY ESTABLISHED AND ADOPTED BY ALTA AND NPS, AND INCLUDES ITEMS 1-5, 6(A)(B), 11(A)(B) AND 18-20 OF TABLE A THEREOF. THE FIELD WORK WAS COMPLETED ON AUGUST 16th, 2011.

THIS PROFESSIONAL SERVICE CONFORMS TO THE CURRENT ILLINOIS MINIMUM STANDARDS FOR BOUNDARY SURVEYS.

DATED AT PLAINFIELD, ILLINOIS THIS 19th DAY OF AUGUST, 2011.

KEITH E. BOLLINGER  
LAWSON & ASSOCIATES, INC.  
ILLINOIS PROFESSIONAL DESIGN FIRM NO. 184-003041  
KEITH E. BOLLINGER (P.S. NO. 35-3592)  
LICENSE EXPIRES 11-30-2012



## GREENSCAPE HOMES, LLC

GREEN ACRES OF DOWNERS GROVE  
DOWNERS GROVE, ILLINOIS

|                             |                             |                 |
|-----------------------------|-----------------------------|-----------------|
| ALTA/ACSM LAND TITLE SURVEY | DRAWN BY: TCB               | CHECKED BY: KEB |
|                             | SCALE: 1"=30'               | DATE: 08/17/11  |
|                             | JOB NUMBER: 11-157 (03-164) | SHEET: 1 OF 1   |



Consulting Civil Engineering  
Land Planning & Surveying  
1050 State Route 126  
Plainfield, Illinois 60544  
voice 815-254-0505  
fax 815-436-5158

© Copyright, 2011 C. M. Lavoie & Associates, Inc.  
This plan is protected under the copyright laws of the United States of America and foreign countries, and is to be used solely at the discretion of the Owner and C.M. Lavoie & Associates, Inc. Any use of this plan without the permission of the Owner and/or C.M. Lavoie & Associates, Inc., constitutes a violation of C.M. Lavoie & Associates, Inc.'s copyright of this plan and is prohibited.

# AS-BUILT WALL EXHIBIT

OF  
 LOTS 12, 13 AND 14 IN GREEN ACRES OF DOWNERS GROVE IN THE NORTHEAST QUARTER OF SECTION 20,  
 TOWNSHIP 38 NORTH, RANGE 11 EAST OF THE THIRD PRINCIPAL MERIDIAN, ACCORDING TO THE PLAT THEREOF  
 RECORDED JUNE 1, 2004 AS DOCUMENT R2004-144920 AND CERTIFICATES OF CORRECTION RECORDED MAY  
 27, 2005 AS DOCUMENT R2005-110474 AND RECORDED FEBRUARY 2, 2006 AS DOCUMENT R2006-021295, IN  
 DUPAGE COUNTY, ILLINOIS

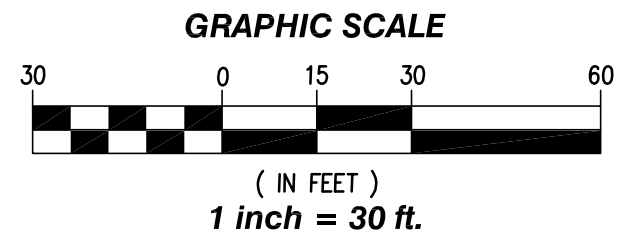
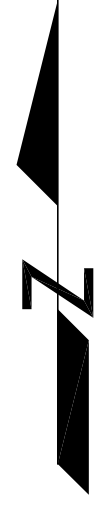

## LEGEND

- 0.00' MEASURED DATA
- (0.00') RECORD DATA
- LIMIT OF SURVEY
- AS-BUILT WALL
- T/W TOP OF WALL
- B/W BOTTOM OF WALL
- 756.1 PROPOSED GRADE
- 756.1 AS-BUILT GRADE
- xxx- AS-BUILT CONTOUR
- xxx PROPOSED CONTOUR

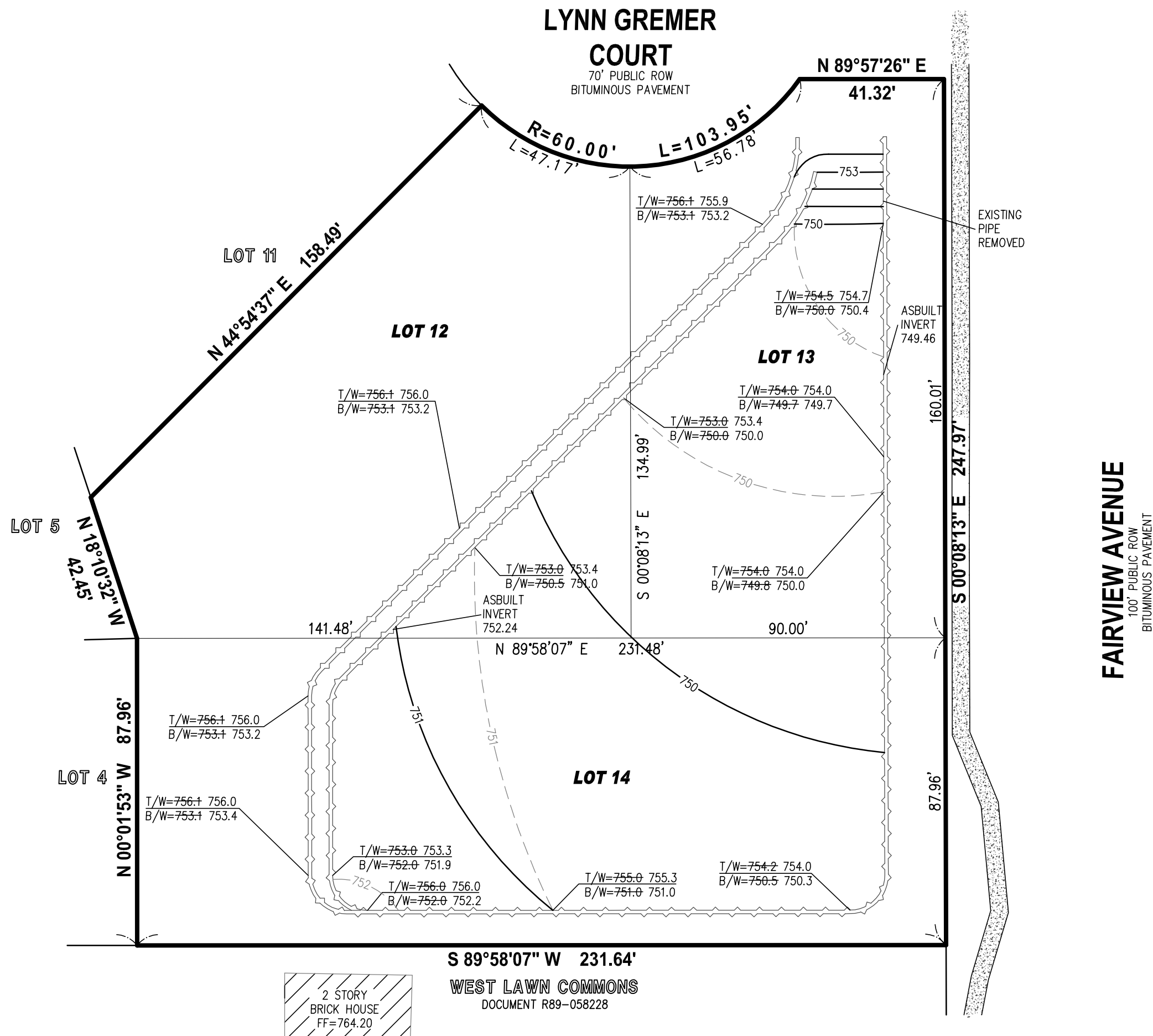

## NOTES

- DIMENSIONS SHOWN THUS: 50.25' ARE FEET AND DECIMAL PARTS THEREOF. ANGULAR DATA SHOWN THUS: 90°00'00" INDICATES DEGREES, MINUTES AND SECONDS.
- NORTH ARROW AND BEARINGS BASED ON THE WEST RIGHT-OF-WAY LINE OF FAIRVIEW AVENUE TO BE SOUTH 00 DEGREES 08 MINUTES 13 SECONDS EAST.
- IMPROVEMENT LOCATIONS ARE BASED ON A FIELD SURVEY BY C.M. LAVOIE AND ASSOCIATES, INC. ON DECEMBER 16, 2011. THERE MAY BE OTHER IMPROVEMENTS DONE TO THE SUBJECT PROPERTY THAT ARE NOT SHOWN.
- COMPARE YOUR POINTS BEFORE USING SAME AND REPORT ANY DIFFERENCES IMMEDIATELY.

## PROPOSED DETENTION VOLUME (LOT 12, 13, 14)

| ELEVATION (FT)             | AREA (Square Feet) | A1+A2+Sqrt (A1*A2) (Acres) | VOLUME (AC - FT) | VOLUME SUM (AC - FT) | DISCHARGE* (cfs) |
|----------------------------|--------------------|----------------------------|------------------|----------------------|------------------|
| 749.40                     | 0                  | 0.00                       | 0.00             | 0.00                 | 0                |
| 750.00                     | 10017              | 0.23                       | 0.05             | 0.05                 | 0.04             |
| 751.00                     | 19883              | 1.01                       | 0.34             | 0.38                 | 0.21             |
| 752.00                     | 22335              | 1.45                       | 0.48             | 0.87                 | 0.28             |
| 753.00                     | 22431              | 1.54                       | 0.51             | 1.38                 | 0.31             |
| 754.00                     | 24149              | 1.60                       | 0.53             | 1.92                 | 0.34             |
| <b>PROPOSED DETENTION=</b> |                    |                            | <b>1.92</b>      |                      |                  |

\*DISCHARGE RATES TAKEN FROM PONDPACK OUTPUT

VOLUME = (1/3) \* (EL2 - EL1) \* (A1 + A2 + Sqrt (A1 \* A2))  
 EL1, EL2 = Lower and upper elevations of the increment  
 A1, A2 = Areas computed for EL1 and EL2  
 Volume = Incremental volume between EL1 and EL2

## AS-BUILT DETENTION VOLUME (LOT 12, 13, 14)

| ELEVATION (FT)             | AREA (Square Feet) | A1+A2+Sqrt (A1*A2) (Acres) | VOLUME (AC - FT) | VOLUME SUM (AC - FT) |
|----------------------------|--------------------|----------------------------|------------------|----------------------|
| 749.70                     | 3                  | 0.00                       | 0.00             | 0.00                 |
| 750.00                     | 3322               | 0.08                       | 0.01             | 0.01                 |
| 751.00                     | 18159              | 0.67                       | 0.22             | 0.23                 |
| 752.00                     | 22226              | 1.39                       | 0.46             | 0.69                 |
| 753.00                     | 22430              | 1.54                       | 0.51             | 1.21                 |
| 753.35                     | 22430              | 1.54                       | 0.18             | 1.39                 |
| 753.40                     | 24081              | 1.60                       | 0.03             | 1.41                 |
| 754.00                     | 24149              | 1.66                       | 0.33             | 1.75                 |
| <b>AS-BUILT DETENTION=</b> |                    |                            | <b>1.75</b>      |                      |

VOLUME = (1/3) \* (EL2 - EL1) \* (A1 + A2 + Sqrt (A1 \* A2))  
 EL1, EL2 = Lower and upper elevations of the increment  
 A1, A2 = Areas computed for EL1 and EL2  
 Volume = Incremental volume between EL1 and EL2

## GREENSCAPE HOMES, LLC

FAIRVIEW AVENUE & LYNN GREMER COURT  
 DOWNERS GROVE, ILLINOIS

### AS-BUILT WALL EXHIBIT

DRAWN BY: TCB CHECKED BY: KEB

SCALE: 1"=30' DATE: 12/20/11

JOB NUMBER: 11-157 SHEET: 1 OF 1



Consulting Civil Engineering  
 Land Planning & Surveying  
 1050 W. Route 126  
 Plainfield, Illinois 60544  
 voice 815-454-0505  
 fax 815-436-5158

C.M. Lavoie  
 & Associates, Inc.

| # | DATE       | DESCRIPTION          |
|---|------------|----------------------|
| 1 | 02/06/2012 | REVISED PER ENGINEER |

P.I.Nos  
09-20-213-017  
09-20-213-018  
09-20-213-019

# FINAL PLAT FIRST RESUBDIVISION OF GREEN ACRES OF DOWNERS GROVE SUBDIVISION

BEING A SUBDIVISION OF PART OF THE NORTHEAST QUARTER  
OF SECTION 20, TOWNSHIP 38 NORTH, RANGE 11 EAST OF THE  
THIRD PRINCIPAL MERIDIAN, IN DuPAGE COUNTY, ILLINOIS

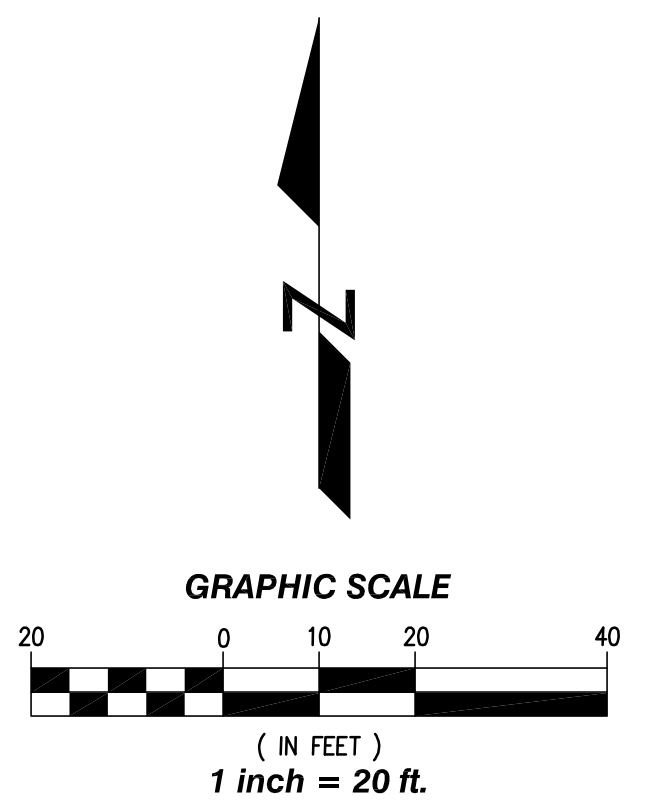

**LEGEND**

- 0.00' MEASURED & RECORDED DATA
- LIMIT OF SURVEY
- PROPOSED LOT LINE
- EXISTING LOT LINE
- SECTION LINE
- EXISTING RIGHT-OF-WAY LINE
- EXISTING EASEMENT LINE
- EXISTING SETBACK LINE
- PROPOSED EASEMENT LINE (HEREBY GRANTED)
- EXISTING EASEMENT LINE (HEREBY ABROGATED)
- EXISTING SETBACK LINE (HEREBY ABROGATED)
- SET 5/8" DIAMETER x 24" LENGTH IRON ROD AT CORNER
- SET 4" SQUARE x 24" LENGTH CONCRETE MONUMENT AT CORNER
- U&D UTILITY AND DRAINAGE EASEMENT
- ( LOT 12 ) RECORD LOT TO BE RE-SUBDIVIDED
- L1 N 44°54'37" E, 7.07'
- L2 S 44°54'37" W, 7.06'

\*NOTE\* ALL U&D AND STORMWATER MANAGEMENT EASEMENTS WITHIN THIS SUBDIVISION ARE SUBJECT TO THE RULES AND REGULATIONS AS OUTLINED IN THE DECLARATION OF COVENANTS, CONDITIONS, EASEMENTS AND RESTRICTIONS FOR THE HOMEOWNERS' ASSOCIATION FOR THE FIRST RESUBDIVISION OF GREEN ACRES OF DOWNERS GROVE SUBDIVISION.

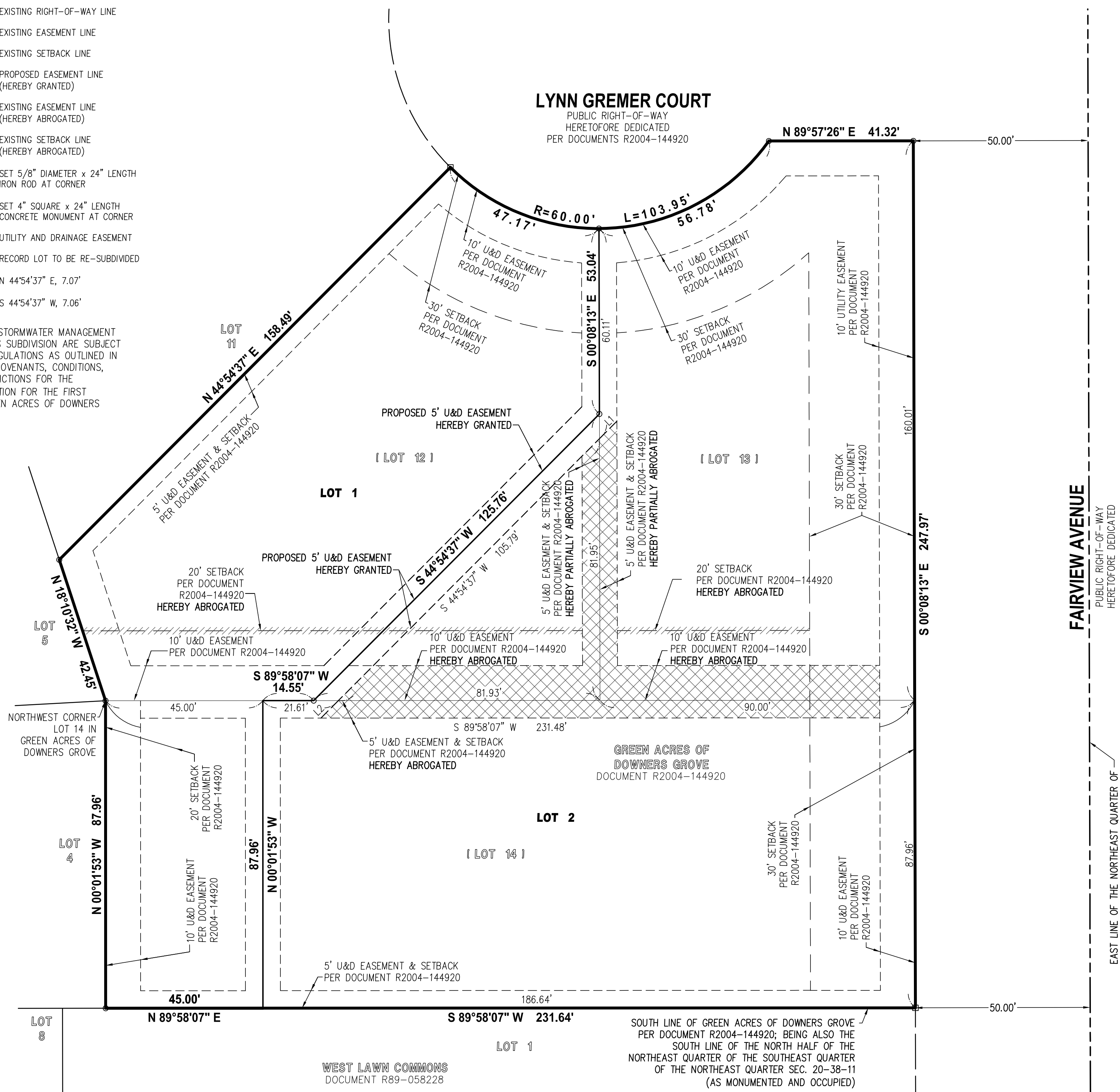

**SETBACK LINE OVER LOT 12  
IN GREEN ACRES OF DOWNERS GROVE SUBDIVISION  
HEREBY ABROGATED AS FOLLOWS**

20 FOOT REAR SETBACK LINE FOR LOT 12 IN GREEN ACRES OF DOWNERS GROVE SUBDIVISION PER DOCUMENT R2004-144920.

**U&D EASEMENT OVER LOT 12  
IN GREEN ACRES OF DOWNERS GROVE SUBDIVISION  
HEREBY ABROGATED AS FOLLOWS**

THAT PART OF THE SOUTH 10 FEET OF LOT 12 IN GREEN ACRES OF DOWNERS GROVE SUBDIVISION PER DOCUMENT R2004-144920, LYING EAST OF THE FOLLOWING DESCRIBED LINE:

COMMENCING AT THE NORTHEAST CORNER OF SAID LOT 12, THENCE SOUTH 00 DEGREES 08 MINUTES 13 SECONDS EAST ALONG THE EAST LINE OF SAID LOT 12, A DISTANCE OF 60.11 FEET; THENCE SOUTH 44 DEGREES 54 MINUTES 37 SECONDS WEST, A DISTANCE OF 105.79 FEET TO A POINT ON THE SOUTH LINE OF SAID LOT 12, SAID POINT BEING THE POINT OF TERMINATION OF THIS LINE.

AND ALSO THAT PART OF THE EAST 5 FEET OF LOT 12 IN GREEN ACRES OF DOWNERS GROVE SUBDIVISION PER DOCUMENT R2004-144920, LYING SOUTH OF THE FOLLOWING DESCRIBED LINE:

COMMENCING AT THE NORTHEAST CORNER OF SAID LOT 12, THENCE SOUTH 00 DEGREES 08 MINUTES 13 SECONDS EAST ALONG THE EAST LINE OF SAID LOT 12, A DISTANCE OF 60.11 FEET; THENCE SOUTH 44 DEGREES 54 MINUTES 37 SECONDS WEST, A DISTANCE OF 105.79 FEET TO A POINT ON THE SOUTH LINE OF SAID LOT 12, SAID POINT BEING THE POINT OF TERMINATION OF THIS LINE.

**SETBACK LINE OVER LOT 13  
IN GREEN ACRES OF DOWNERS GROVE SUBDIVISION  
HEREBY ABROGATED AS FOLLOWS**

20 FOOT REAR SETBACK LINE FOR LOT 13 IN GREEN ACRES OF DOWNERS GROVE SUBDIVISION PER DOCUMENT R2004-144920.

**U&D EASEMENT OVER LOT 13  
IN GREEN ACRES OF DOWNERS GROVE SUBDIVISION  
HEREBY ABROGATED AS FOLLOWS**

THE SOUTH 10 FEET (EXCEPT THE EAST 10 FEET THEREOF) OF LOT 13 IN GREEN ACRES OF DOWNERS GROVE SUBDIVISION PER DOCUMENT R2004-144920

AND ALSO THAT PART OF THE WEST 5 FEET OF LOT 13 IN GREEN ACRES OF DOWNERS GROVE SUBDIVISION PER DOCUMENT R2004-144920, LYING SOUTH OF THE FOLLOWING DESCRIBED LINE:

COMMENCING AT THE NORTHWEST CORNER OF SAID LOT 13, THENCE SOUTH 00 DEGREES 08 MINUTES 13 SECONDS EAST ALONG THE WEST LINE OF SAID LOT 13, A DISTANCE OF 60.11 FEET FOR A POINT OF BEGINNING; THENCE NORTH 44 DEGREES 54 MINUTES 37 SECONDS EAST, A DISTANCE OF 7.07 FEET FOR A POINT OF TERMINATION OF THIS LINE.

**U&D EASEMENT AND SETBACK LINE OVER LOT 14  
IN GREEN ACRES OF DOWNERS GROVE SUBDIVISION  
HEREBY ABROGATED AS FOLLOWS**

THAT PART OF THE NORTH 5 FEET OF LOT 14 IN GREEN ACRES OF DOWNERS GROVE SUBDIVISION PER DOCUMENT R2004-144920, LYING EAST OF THE FOLLOWING DESCRIBED LINE:

COMMENCING AT THE NORTHWEST CORNER OF SAID LOT 14, THENCE NORTH 89 DEGREES 58 MINUTES 07 SECONDS EAST, A DISTANCE OF 66.61 FEET FOR A POINT OF BEGINNING; THENCE SOUTH 44 DEGREES 54 MINUTES 37 SECONDS WEST, A DISTANCE OF 7.06 FEET FOR A POINT OF TERMINATION OF THIS LINE.

**DOWNERS GROVE VILLAGE ENGINEER'S CERTIFICATE  
(FOR ABROGATION OF EASEMENT)**

ABROGATION OF THE EASEMENTS DESIGNATED TO BE ABROGATED HEREON APPROVED AND ACCEPTED THIS \_\_\_\_\_ DAY OF \_\_\_\_\_, 2012.

BY: \_\_\_\_\_ TITLE: \_\_\_\_\_

**DOWNERS GROVE PUBLIC WORKS CERTIFICATE  
(FOR ABROGATION OF EASEMENT)**

ABROGATION OF THE EASEMENTS DESIGNATED TO BE ABROGATED HEREON APPROVED AND ACCEPTED THIS \_\_\_\_\_ DAY OF \_\_\_\_\_, 2012.

BY: \_\_\_\_\_ TITLE: \_\_\_\_\_

**DOWNERS GROVE SANITARY DISTRICT CERTIFICATE  
(FOR ABROGATION OF EASEMENT)**

ABROGATION OF THE EASEMENTS DESIGNATED TO BE ABROGATED HEREON APPROVED AND ACCEPTED THIS \_\_\_\_\_ DAY OF \_\_\_\_\_, 2012.

BY: \_\_\_\_\_ TITLE: \_\_\_\_\_

**DOWNERS GROVE VILLAGE COUNCIL'S CERTIFICATE  
(FOR ABROGATION OF EASEMENT)**

ABROGATION OF THE EASEMENTS DESIGNATED TO BE ABROGATED HEREON APPROVED AND ACCEPTED THIS \_\_\_\_\_ DAY OF \_\_\_\_\_, 2012.

MAYOR: \_\_\_\_\_ VILLAGE CLERK: \_\_\_\_\_

**COMCAST'S CERTIFICATE  
(FOR ABROGATION OF EASEMENT)**

ABROGATION OF THE EASEMENTS DESIGNATED TO BE ABROGATED HEREON APPROVED AND ACCEPTED THIS \_\_\_\_\_ DAY OF \_\_\_\_\_, 2012.

BY: \_\_\_\_\_ TITLE: \_\_\_\_\_

**NICOR'S CERTIFICATE  
(FOR ABROGATION OF EASEMENT)**

ABROGATION OF THE EASEMENTS DESIGNATED TO BE ABROGATED HEREON APPROVED AND ACCEPTED THIS \_\_\_\_\_ DAY OF \_\_\_\_\_, 2012.

BY: \_\_\_\_\_ TITLE: \_\_\_\_\_

**COMED'S CERTIFICATE  
(FOR ABROGATION OF EASEMENT)**

ABROGATION OF THE EASEMENTS DESIGNATED TO BE ABROGATED HEREON APPROVED AND ACCEPTED THIS \_\_\_\_\_ DAY OF \_\_\_\_\_, 2012.

BY: \_\_\_\_\_ TITLE: \_\_\_\_\_

**AT&T'S CERTIFICATE  
(FOR ABROGATION OF EASEMENT)**

ABROGATION OF THE EASEMENTS DESIGNATED TO BE ABROGATED HEREON APPROVED AND ACCEPTED THIS \_\_\_\_\_ DAY OF \_\_\_\_\_, 2012.

BY: \_\_\_\_\_ TITLE: \_\_\_\_\_

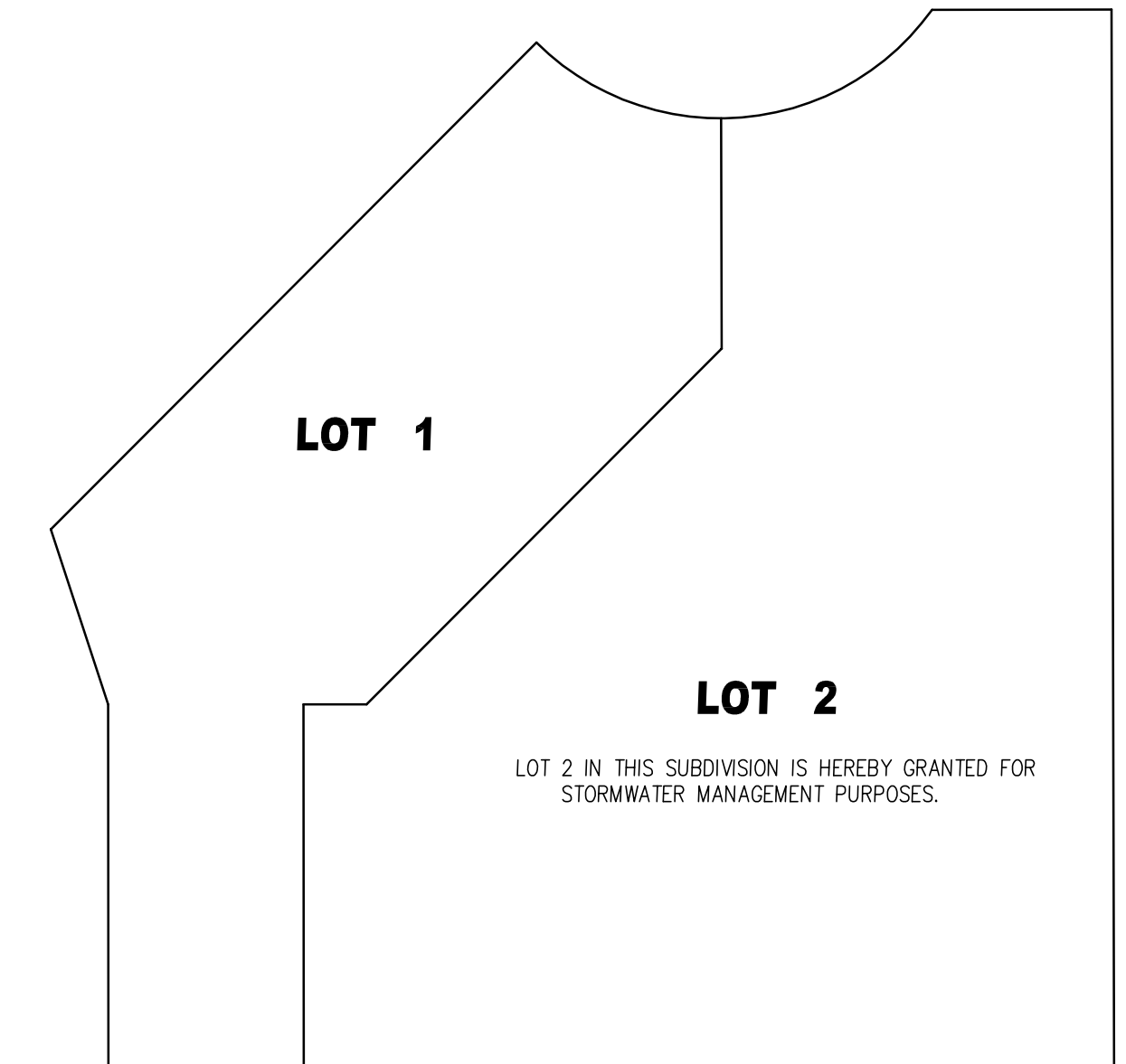

**LOT 1**

**LOT 2**

LOT 2 IN THIS SUBDIVISION IS HEREBY GRANTED FOR STORMWATER MANAGEMENT PURPOSES.

**LOT AREA**  
LOT 1 ~ 17,115 SQUARE FEET OR 0.393 ACRES +/-  
LOT 2 ~ 33,316 SQUARE FEET OR 0.765 ACRES +/-

**SURVEYOR'S NOTES**

1. DIMENSIONS SHOWN THUS: 50.25' ARE FEET AND DECIMAL PARTS THEREOF. ANGULAR DATA SHOWN THUS: 90°00'00" INDICATES DEGREES, MINUTES AND SECONDS.
2. A BLANKET EASEMENT FOR STORMWATER MANAGEMENT WAS GRANTED OVER ALL OF LOTS 12, 13 AND 14 IN GREEN ACRES OF DOWNERS GROVE SUBDIVISION IS HEREBY VACATED PER THIS DOCUMENT.
3. A BLANKET EASEMENT IS HEREBY GRANTED OVER ALL OF LOT 2 IN THIS SUBDIVISION FOR STORMWATER MANAGEMENT PURPOSES.

**GREENSCAPE HOMES, LLC**  
FAIRVIEW AVENUE & LYNN GREMER COURT  
DOWNERS GROVE, ILLINOIS

|   |   |                |                                  |
|---|---|----------------|----------------------------------|
| <b>PLAT OF RESUBDIVISION</b>  |   | DRAWN BY: TCB  | CHECKED BY: KEB                  |
| SCALE: 1"=20'   |   | DATE: 12/12/11 |                                  |
| JOB NUMBER: 11-157  |   | SHEET: 1 OF 2  |                                  |
| <p><b>C.M. Lavoie &amp; Associates, Inc.</b><br/>Consulting Civil Engineering<br/>Land Planning &amp; Surveying<br/>1050 State Route 126<br/>Plainfield, Illinois 60544<br/>voice 815-254-0505<br/>fax 815-436-5158</p> | # | DATE           | DESCRIPTION                      |
|   | 1 | 1/17/12        | REV. PER VILLAGE LTR DTD 1/11/12 |
|   | 2 | 2/07/12        | REV. PER VILLAGE LTR DTD 2/3/12  |
|   | 3 |                |                                  |
|   | 4 |                |                                  |
|   | 5 |                |                                  |
|   | 6 |                |                                  |
|   | 7 |                |                                  |

© Copyright, 2012 C. M. Lavoie & Associates, Inc.  
This plan is protected under the copyright laws of the United States of America and foreign countries, and is to be used solely at the discretion of the Owner and C.M. Lavoie & Associates, Inc. Any use of this plan without the permission of the Owner and/or C.M. Lavoie & Associates, Inc., constitutes a violation of C.M. Lavoie & Associates, Inc.'s copyright of this plan and is prohibited.



| TASK   | WEEK 1 | WEEK 2 | WEEK 3 | WEEK 4 | WEEK 5 |
|--|--------|--------|--------|--------|--------|
| INSTALLATION OF PERIMETER CONTROLS, STABILIZED CONSTRUCTION ENTRANCE, INLET PROTECTION DITCH CHECKS AND SILT FENCE |        |        |        |        |        |
| MASS GRADING AND STABILIZATION OF DETENTION POND   |        |        |        |        |        |
| STORM SEWER & INSTALLATION & REMOVAL   |        |        |        |        |        |
| RETAINING WALL CONSTRUCTION  |        |        |        |        |        |
| FINE GRADING   |        |        |        |        |        |
| SODDING, SEEDING & FINAL STABILIZATION   |        |        |        |        |        |

PROVIDED DETENTION VOLUME (LOT 12, 13, 14)

| ELEVATION (FT)      | AREA (Square Feet) | AHAD-Sqft (A*H) | VOLUME (AC-FT) | VOLUME SUM (AC-FT) | DISCHARGE (cfs) |
|---------------------|--------------------|-----------------|----------------|--------------------|-----------------|
| 748.41              | 0                  | 0.00            | 0.00           | 0.00               | 0               |
| 750.00              | 15017              | 0.23            | 0.23           | 0.23               | 0.06            |
| 751.00              | 19883              | 1.91            | 0.34           | 0.38               | 0.21            |
| 752.00              | 22335              | 1.45            | 0.48           | 0.87               | 0.28            |
| 753.00              | 28431              | 1.54            | 0.51           | 1.38               | 0.31            |
| 754.00              | 24149              | 1.60            | 0.31           | 1.69               | 0.34            |
| PROVIDED DETENTION: |                    |                 |                | 1.92               | 0.34            |

\*DISCHARGE RATES TAKEN FROM PONDPACK OUTPUT

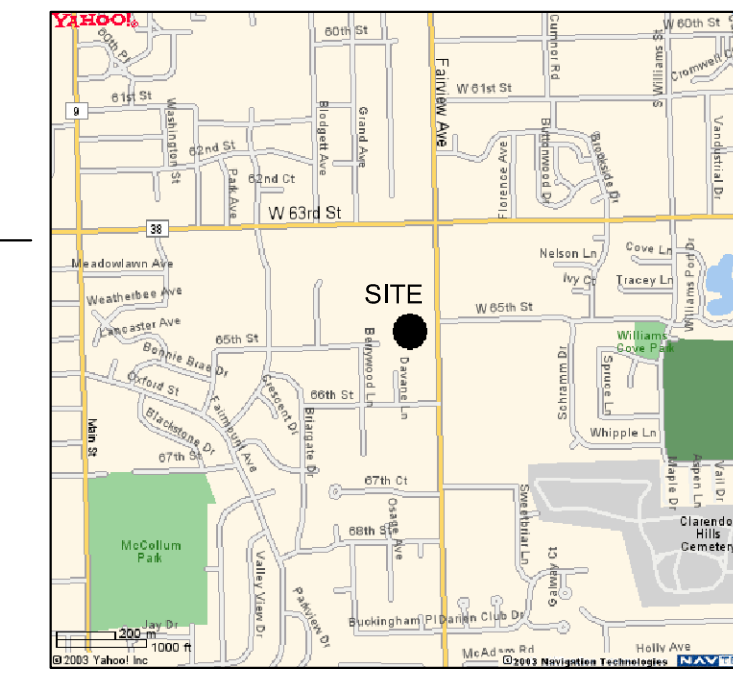

SITE LOCATION

SILT FENCE PLAN

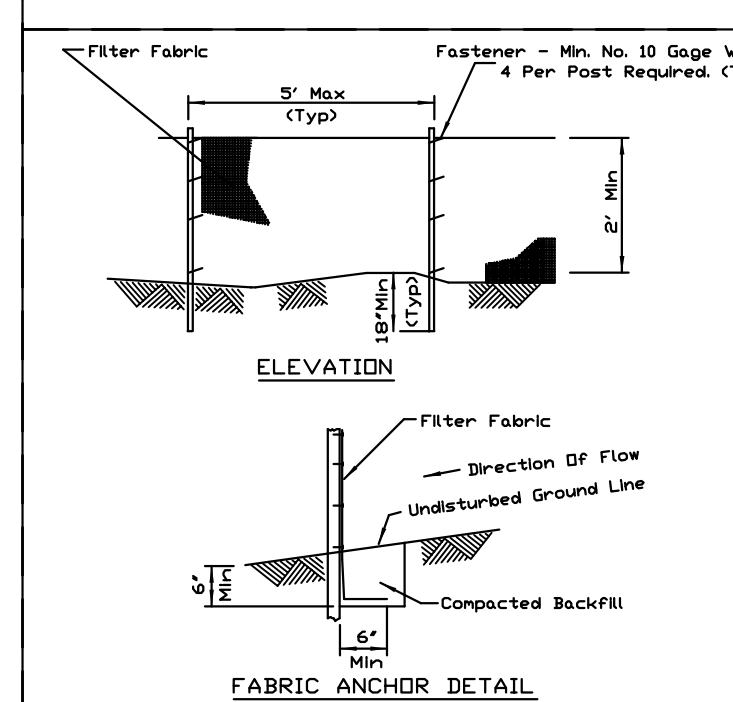

- NOTES:
- Temporary sediment fence shall be installed prior to any grading work in the area to be protected. They shall be maintained throughout the construction period and removed in conjunction with the final grading and site stabilization.
  - Filter fabric shall meet the requirements of material specification 300 Geotextile Fabric 1 or 2, Class 1 with equivalent opening size of at least 30 for nonwoven and 50 for woven.
  - Fence posts shall be either standard steel post or wood post with a minimum cross-sectional area of 3.0 sq. in.

Project: EX03 - Detention Basin Exhibit  
 Design: [Signature]  
 Date: [Date]

**NRCS**  
 National Resource Conservation Service

STANDARD DRAWING NO. 11-420  
 SHEET 1 OF 4  
 DATE: 11-15-11

APPROXIMATE INSTALLATION SCHEDULE

- NOTES:
- THE LOCATIONS OF EXISTING UNDERGROUND UTILITIES, SUCH AS WATER MAINS, SEWERS, GAS LINES, ELECTRIC LINES, TELEPHONE LINES, ETC., AS SHOWN ON THE PLANS HAVE BEEN DETERMINED FROM THE BEST AVAILABLE INFORMATION AND IS GIVEN FOR THE CONVENIENCE OF THE CONTRACTOR. HOWEVER, THE ENGINEER AND OWNER DO NOT ASSUME RESPONSIBILITY FOR THE ACCURACY OF THE LOCATIONS SHOWN. IT SHALL BE THE CONTRACTOR'S RESPONSIBILITY TO CONTACT ALL UTILITY COMPANIES AND THEIR FACILITIES SHALL BE LOCATED PRIOR TO ANY WORK.
  - EXISTING GRADES AND IMPROVEMENTS ARE SHOWN FROM THE BEST INFORMATION AVAILABLE AND MUST BE VERIFIED IN THE FIELD BY THE CONTRACTOR PRIOR TO THE START OF CONSTRUCTION. ANY DISCREPANCY WITH THE PLAN SHALL BE IMMEDIATELY REPORTED TO THE ENGINEER.
  - PRIOR TO THE START OF CONSTRUCTION, THE CONTRACTOR SHALL EXPOSE ANY UTILITIES OR OTHER OBSTRUCTIONS TO BE CROSSED BY THE PROPOSED SEWER, AND SHALL NOTIFY THE ENGINEER IMMEDIATELY IF THERE ARE ANY CONFLICTS WITH THE PROPOSED SEWER GRADE.
  - STABILIZED CONSTRUCTION ENTRANCE SHALL CONSIST OF CA-3 STONE BASE 12" DEPTH MINIMUM.
  - ACCESS TO THE SITE SHALL BE LIMITED TO THE STABILIZED CONSTRUCTION ENTRANCE, UNLESS PRIOR APPROVAL FROM THE VILLAGE OF DOWNERS GROVE.
  - EROSION CONTROL MEASURES SHALL CONFORM TO "PROCEDURES AND STANDARDS FOR URBAN SOIL EROSION AND SEDIMENTATION CONTROL IN ILLINOIS" LATEST EDITION, AND FURTHER MEASURES AS DEEMED NECESSARY.
  - TEMPORARY VEGETATION OR, WHEN APPROPRIATE, MULCHING OR OTHER NONVARIABLE COVER SHALL BE USED TO PROTECT AREAS EXPOSED DURING DEVELOPMENT.
  - PERMANENT SEEDING AREAS SHALL RECEIVE 16 LBS/ACRE CREEPING RED FESCUE AND 68 LBS/ACRE KENTUCKY BLUEGRASS OR SEEDING RATE AS NOTED.
  - STRAW BALES SHALL BE SPREAD AT A RATE OF TWO BALES/ACRE IN ALL PERMANENT SEEDING AREAS.
  - FERTILIZER SHOULD BE APPLIED PRIOR TO SEEDING AT THE FOLLOWING RATES:  
 NITROGEN 130 LBS/ACRE  
 PHOSPHORUS 130 LBS/ACRE  
 POTASSIUM 130 LBS/ACRE
  - CONTRACTOR TO CLEAN FAIRVIEW AVENUE DAILY DURING CONSTRUCTION OR AS DIRECTED BY ENGINEER.
  - ALL AREAS BETWEEN THE CURB AND THE WALK ARE TO BE SODDED.
  - PROTECTIVE GRATES ARE REQUIRED FOR ALL FLARED END SECTIONS.
  - PLACE MIRAFI 14 ON GEOTEXTILE FABRIC OR APPROVED EQUAL UNDER RIP-RAP AT BOTH OUTLETS OF FLARED END SECTIONS AND AT OVERFLOW WEIR. INSTALL PER MANUFACTURERS SPECIFICATIONS.
  - RESTORE PARKWAY WITH 6 INCH TOP SOIL AND SOD.
  - ALL SILT FENCE SHALL BE ERECTED AND APPROVED BY THE VILLAGE OF DOWNERS GROVE PRIOR TO CONSTRUCTION.
  - ALL MAINTENANCE AND INSPECTION OF DESCRIBED EROSION CONTROL MEASURES SHOWN ON THIS PLAN SHALL BE IN ACCORDANCE WITH CHAPTER 6 OF "PROCEDURES AND STANDARDS FOR URBAN SOIL EROSION AND SEDIMENTATION CONTROL IN ILLINOIS."
  - ALL EXCESS CLAY EXCAVATED FROM DETENTION POND TO BE HAULED OFFSITE.
  - CONTRACTOR TO INSTALL FINAL LIFT OF SURFACE COURSE ON LYNN GREMER COURT.
  - CONTRACTOR IS RESPONSIBLE TO ADJUST UTILITY STRUCTURES TO FINAL GRADE ON LYNN GREMER COURT TO THE SATISFACTION OF THE VILLAGE OF DOWNERS GROVE.
  - ALL PARKWAYS DISTURBED DURING CONSTRUCTION TO BE RESTORED TO VILLAGE SPECIFICATIONS.
  - ALL CRACKED AND/OR SPALLED CURBS ON LYNN GREMER COURT SHALL BE REPAIRED TO THE SATISFACTION OF THE VILLAGE OF DOWNERS GROVE.
  - SEVEN (7) PARKWAY TREES ON LYNN GREMER COURT AND TEN (10) PARKWAY TREES ON DAVANE LANE TO BE INSTALLED TO THE SATISFACTION OF THE VILLAGE OF DOWNERS GROVE. VILLAGE FORESTER SHALL APPROVE SPECIES OF PARKWAY TREES. TREES SHALL HAVE A MINIMUM TRUNK SIZE OF 2" IN DIAMETER, AS MEASURED 6" ABOVE ESTABLISHED GROUND.
  - ALL STORM SEWER, CONSTRUCTED AS PART OF THIS PROJECT, TO BE CLEANED, INSPECTED AND TELEVIEWED AFTER CONSTRUCTION IS COMPLETED TO ENSURE THEY ARE PROPERLY FUNCTIONING.
  - STOCKPILE AREA IN DETENTION POND IS FOR TEMPORARY USE ONLY. ONLY REQUIRED AMOUNT OF TOPSOIL NEEDED TO RESPREAD IN POND SHALL BE STOCKPILED. CONTRACTOR SHALL HAVE ALL STOCKPILE MATERIAL REMOVED FROM SITE PRIOR TO COMPLETION OF JOB.
  - TOTAL DISTURBED AREA FOR DETENTION POND CONSTRUCTION IS 0.861 ACRES.
  - SANITARY SEWER SERVICE ABANDONMENT WORK MUST BE INSPECTED AND APPROVED BY DOWNERS GROVE SANITARY SEWER DISTRICT INSPECTORS.
  - EXISTING WATER SERVICES FOR LOTS 13 AND 14 SHALL BE DISCONNECTED AT THE WATERMAIN PER VILLAGE REQUIREMENTS.

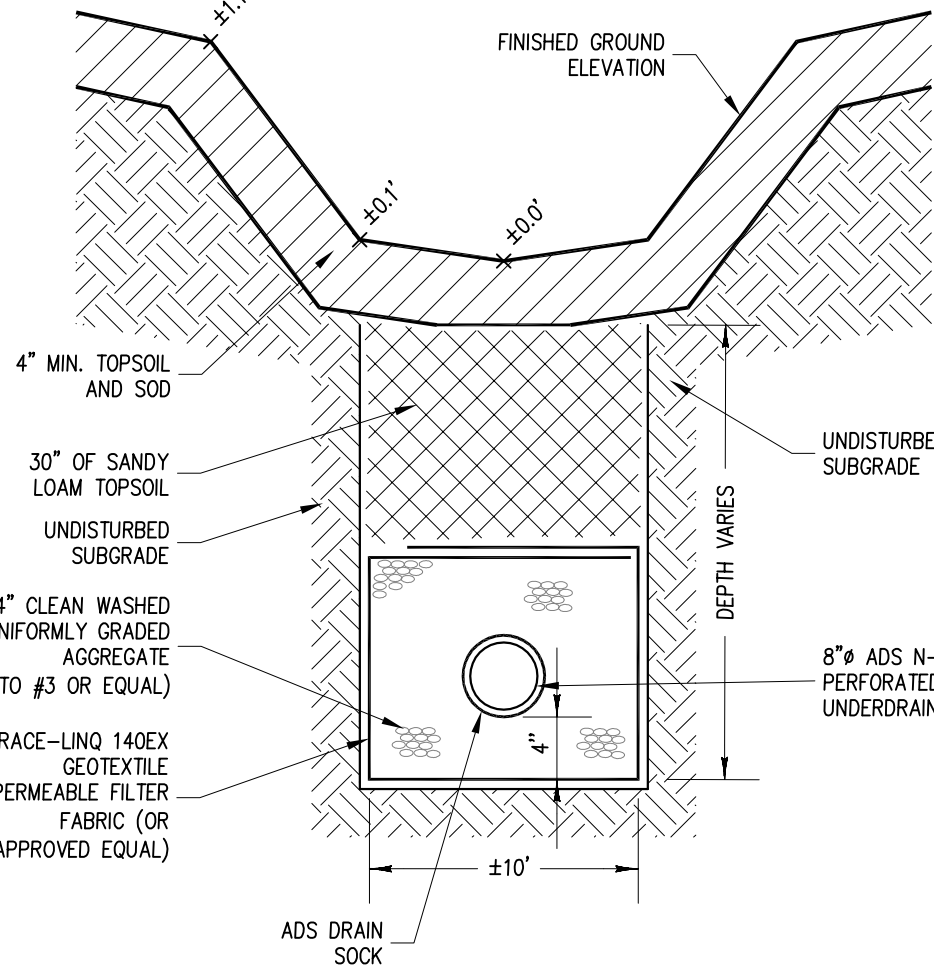

INFILTRATION SWALE DETAIL

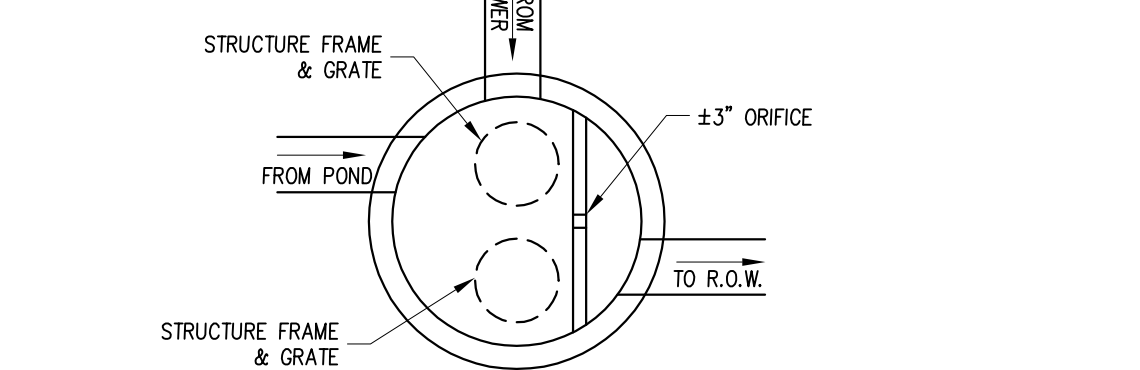

EXISTING OUTLET STRUCTURE DETAIL

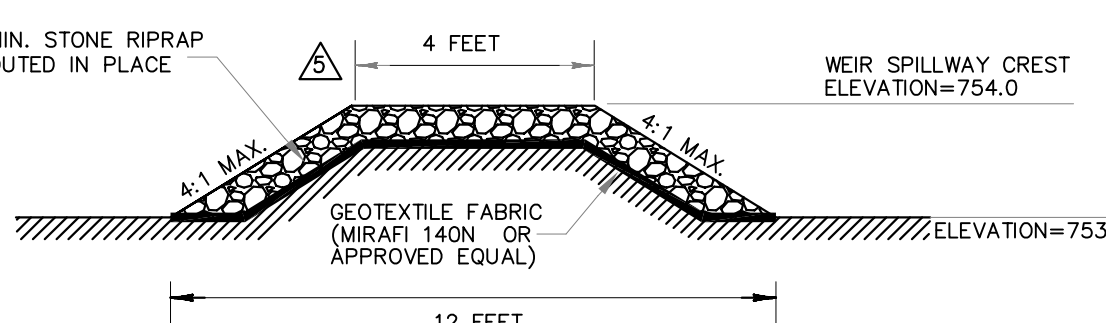

OVERFLOW WEIR

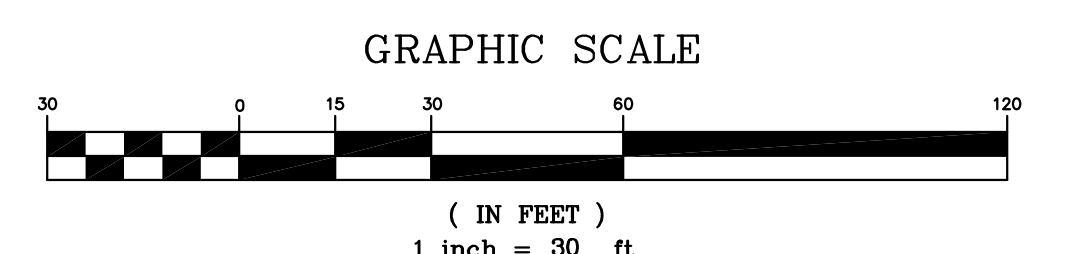
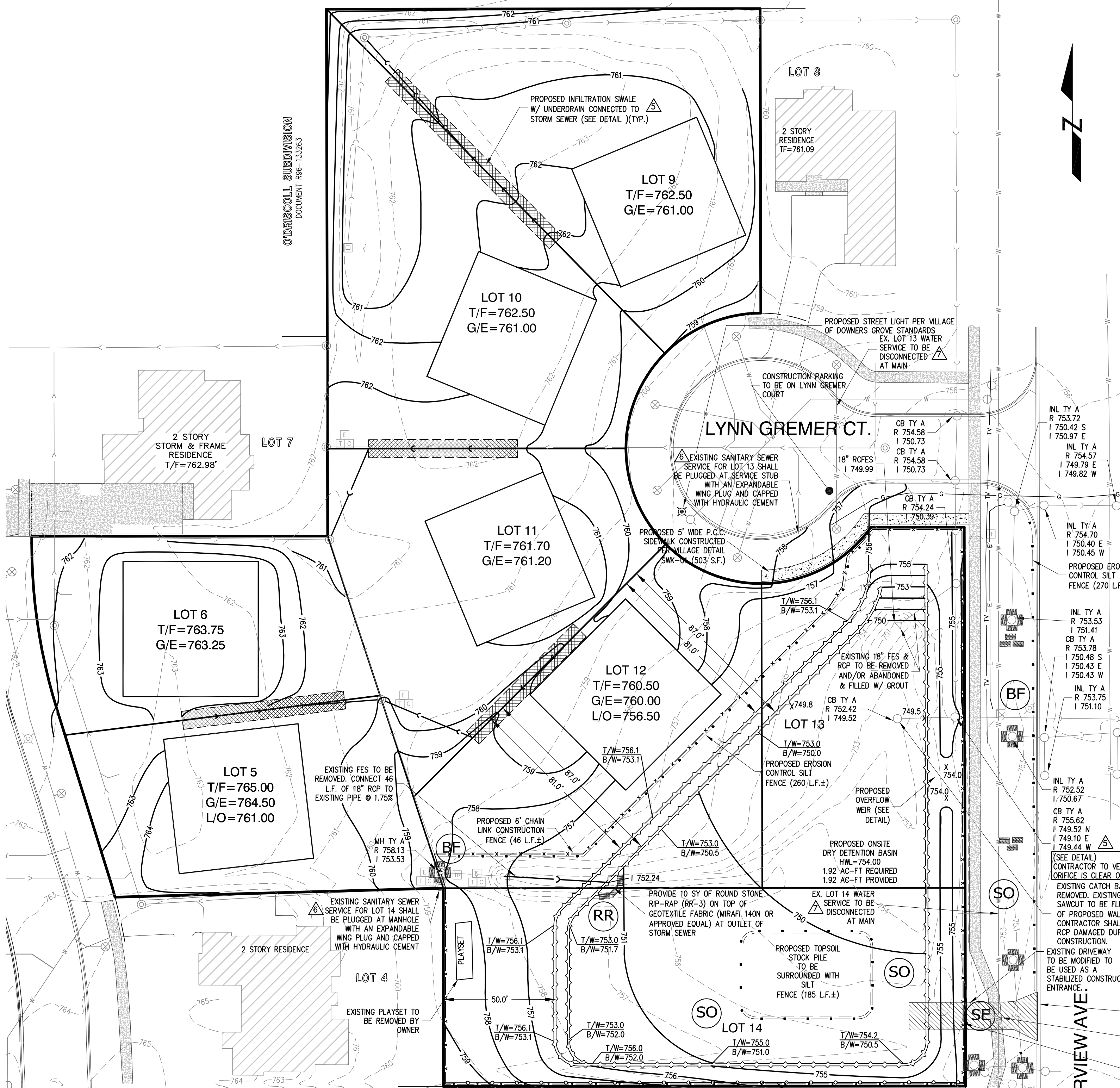
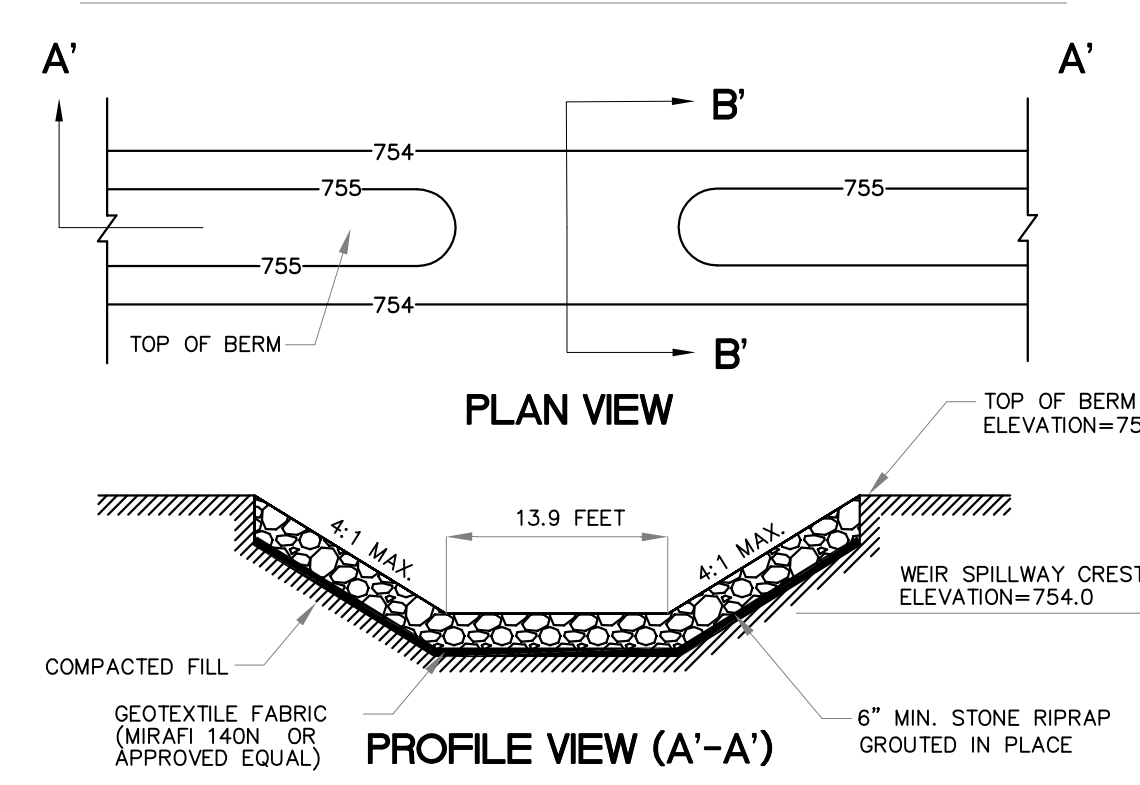

**CALL JULIE**  
 48 Hours (2 working days) Before You Dig.  
 1-800-892-0123

© Copyright, 2012 C. M. Lavoie & Associates, Inc.  
 These plans are protected under the copyright laws of the United States and foreign countries, and are to be used only for the construction and/or repair of the Site Improvements as defined in the contract between the Engineer and the Owner. Any use of these plans, including details and specifications, to construct and/or repair additional items not described in these plans, constitutes a violation of the Engineer's copyright of these plans and is prohibited.

- LEGEND**
- BF BARRIER FILTER
  - SO SODDING
  - SE STABILIZED ENTRANCE
  - SP SHORELINE PROTECTION
  - TS TOPSOIL STOCKPILE
  - RR RIP RAP
  - STRAW BALES
  - AREA OF INFILTRATION SWALE

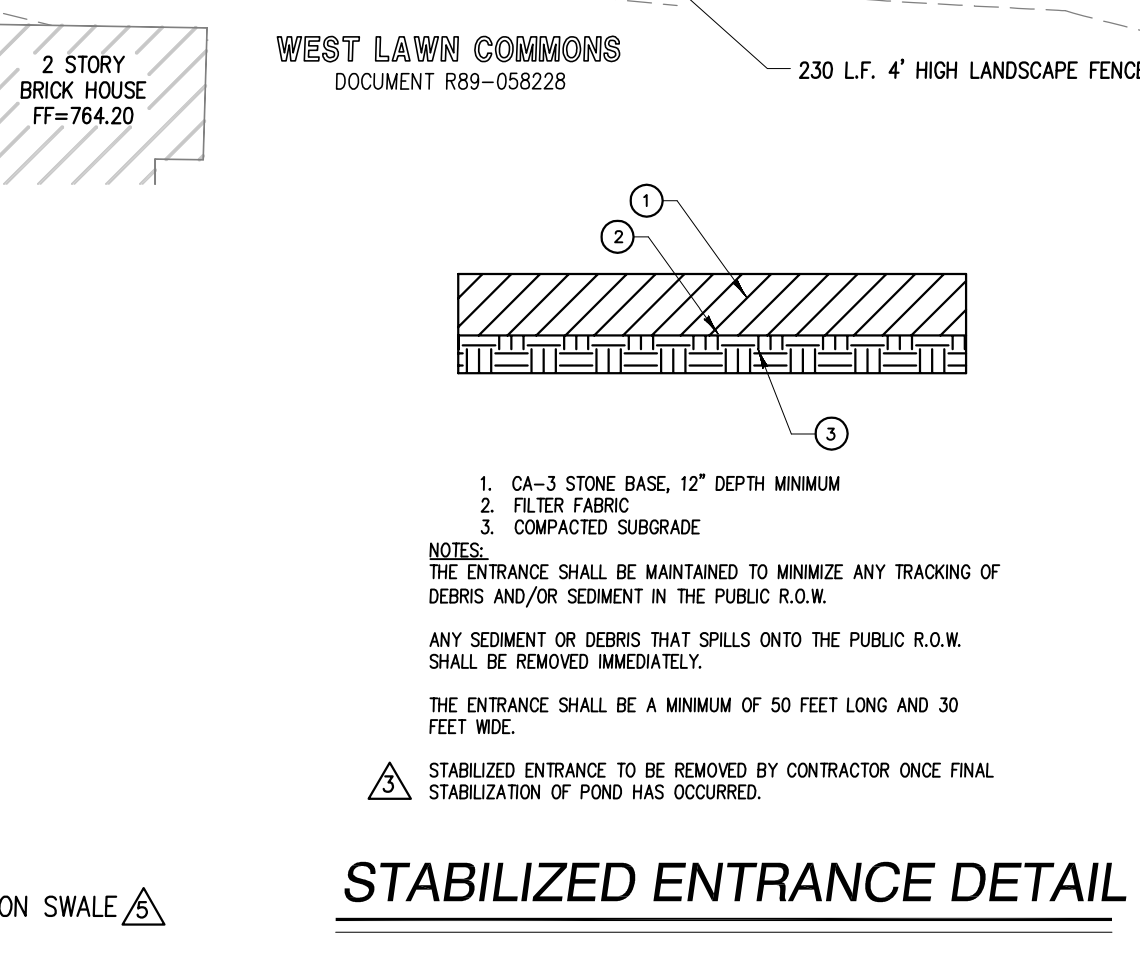

STABILIZED ENTRANCE DETAIL

**GREEN ACRES OF DOWNERS GROVE**  
 FAIRVIEW AVENUE & LYNN GREMER COURT  
 DOWNERS GROVE, ILLINOIS

EX03 - DETENTION BASIN EXHIBIT

DRAWN BY: CNW  
 SCALE: 1"=30'  
 JOB NUMBER: 11-1517

CHECKED BY: TRH  
 DATE: 09-14-11  
 SHEET: 1 OF 1

Consulting Civil Engineering  
 Land Planning & Surveying  
 1050 State Route 126  
 Plainfield, Illinois 60544  
 voice 815-254-0505  
 fax 815-436-5158

| # | DATE       | DESCRIPTION                   |
|---|------------|-------------------------------|
| 1 | 9/16/2011  | REVISED PER ENGINEER          |
| 2 | 9/28/2011  | REVISED PER DEVELOPER         |
| 3 | 10/5/2011  | REVISED PER DEVELOPER         |
| 4 | 10/20/2011 | REVISED PER VILLAGE           |
| 5 | 11/16/2011 | REVISED PER VILLAGE           |
| 6 | 01/04/2012 | REVISED PER SANITARY DISTRICT |
| 7 | 01/14/2012 | REVISED PER VILLAGE           |
| 8 | 02/07/2012 | REVISED PER VILLAGE           |

**C.M. Lavoie & Associates, Inc.**

**PC-06-12** A petition seeking final plat of subdivision approval to re-subdivide three existing lots into two new lots. The property is located at the southwest corner of Fairview Avenue and Lynn Gremer Court, commonly known as 403 and 401 Lynn Gremer Court and 6568 Fairview Avenue Downers Grove, IL (PINs 09-20-213-017, -018, -019) C.M. Lavoie and Associates, Inc., Petitioner; Greenscape Homes, LLC., Owner.

Chairman Jirik swore in those individuals who would be speaking on this petition.

Mr. Latinovic described the petition and location of the project, referring to an aerial photo on the overhead. The proposal was re-subdivide three lots into two new lots. The property was part of the larger Green Acre subdivision originally approved in 2004. He explained the original development included an extension of Davane Lane and the creation of Lynn Gremer Court. Lots 12, 13, and 14, were originally designated for stormwater detention. The current owner purchased the remaining ten lots and redesigned the shape of the detention. Mr. Latinovic noted the redesign of the pond allowed the petitioner to gain another buildable lot. He noted the petition is building three homes around the cul-de-sac. He indicated the petitioner was requesting a final plat of subdivision to create two new lots: Lot 1 and 2. Lot 1 would become a buildable lot while Lot 2 would become stormwater detention.

Mr. Latinovic stated all requirements of the Subdivision and Zoning Ordinances would be met. He noted the owner was not seeking any exceptions. Mr. Latinovic explained where public utility easements would be located on Lot 1. He stated a homeowners association would be created for the subdivision. He explained the applicant was currently completing the public improvements that were required as part of the original development.

Mr. Latinovic stated the proposal was consistent with the Comprehensive Plan; the lots were compatible in size to other surrounding properties. He noted staff recommended that the Plan Commission forward a positive recommendation to the Village Council subject to the conditions listed on page 4 of staff's report.

Regarding the detention area, Mr. Matejczyk asked for clarification for the height of the retaining wall. Mr. Latinovic explained a retaining wall was installed to allow for a deeper basin. Mr. Matejczyk expressed concern about the wall's height. Mr. Latinovic explained the Building Code required a fence or barrier if the drop was more than three feet. In this case, there was a double wall with five feet between walls and a fence would be installed along the south side of the pond, where the grade difference was more than three feet.

Mr. Hose inquired about a previous conservation agreement with regard to a wetland that was removed. Mr. Latinovic stated the wetland was located in another part of the Green Acres subdivision and did not affect this petition. Chairman Jirik noted the Commission should avoid discussing this matter because it did affect the subject properties.

Mr. Ken Neuman, owner of Greenscape Homes, LLC explained the retaining wall mentioned earlier was in place and was a two-step wall. He noted it was located next to the new lot as well as designed to act as a buffer to Lot 6 (to the west), which was part of the original Green Acres subdivision. Mr. Neuman explained the height of the wall would be five feet along the southwest corner. A fence would surround this area. He was working with the current property owner of Lot 6 regarding the installation of that fence. For the record, he stated that Lot 2 of the original Green Acres development contained no wetlands and the designation was subsequently removed.

Mr. Chris Lavoie, CM Lavoie & Associates, stated his office did the design for the original development. He proceeded to explain the history behind the conservation easement when Rosol Construction was the developer. Mr. Lavoie explained that when he did the original design for the development, the detention area (Lots 12, 13 & 14) was originally proposed to go to the pond on the property on the east side of Fairview Avenue (Fairview Ministries property). The Village required stormwater easements on Lots 12, 13 and 14 in the event the developer and Fairview Ministries could not come to an agreement for use of the pond. Mr. Lavoie provided details for the current detention area.

Mrs. Rabatah asked if a cross-section for the retaining wall existed, Mr. Neuman said it was not included in the plans. He indicated the horizontal differential between the two walls was six feet face-to-face. Mr. Tim Hejny clarified the separation was five to six feet. Mrs. Rabatah, however, read the plans differently, looking at the drop, and was not sure how high the concrete was protruding above the grade at the west wall. She indicated she was concerned with safety.

Mr. O'Brien clarified the walls were already installed. He stated staff reviewed the plans for the pond and both walls met the Village's Building Code. Mr. O'Brien stated he thought a fence would be installed to provide additional safety once the basin was complete. He stated the area adjacent to Lot 1 has a two and one-half foot maximum drop, which is acceptable per the Village's codes.

Chairman Jirik opened up the meeting to public comment.

Mr. William Wax, 402 Lynn Gremer Court, opposed "cramming" another house on an irregularly shaped lot next to a detention pond. He voiced safety concerns for the children with regard to the proximity and depth of the detention basin. He said the homes being constructed were smaller than the existing homes and the shape of the lot would not allow for a very large home.

Mr. Latinovic explained the dimensions of the lot, noting they met the subdivision requirements. He noted the building envelope was 60 feet by 132 feet.

Mr. Beggs noted that the original subdivision would have allowed three homes to be built; now only one home was proposed on two lots.

There being no further public comment, Chairman Jirik closed public comment. No Commissioner questions to the public.

Mr. Ken Newman called attention to the fact that the new Lot 1 was the largest lot on Lynn Gremer Court. He noted the home sizes for the other homes under construction on the street. He also indicated the proposed building materials were consistent with the neighboring properties.

**WITH RESPECT TO FILE PC-06-12, MRS. RABATAH MADE A MOTION THAT THE PLAN COMMISSION FORWARD A POSITIVE RECOMMENDATION TO THE VILLAGE COUNCIL, SUBJECT TO STAFF FOLLOWING CONDITIONS:**

- 1. THE FINAL PLAT OF SUBDIVISION SHALL SUBSTANTIALLY CONFORM TO FINAL PLAT OF FIRST RESUBDIVISION OF GREEN ACRES OF DOWNERS GROVE SUBDIVISION PREPARED BY C. M. LAVOIE & ASSOCIATES. INC., DATED DECEMBER 12, 2011, LAST REVISED FEBRUARY 7, 2012 EXCEPT AS SUCH PLAT MAY BE MODIFIED TO CONFORM TO THE VILLAGE CODES AND ORDINANCES.**
- 2. THE HOMEOWNERS ASSOCIATION DECLARATION OF RESTRICTIVE COVENANTS DOCUMENT FOR THE SUBDIVISION SHALL BE RECORDED WITH THE PLAT OF RESUBDIVISION.**
- 3. WATER SERVICE STUBS FOR LOTS 13 AND 14 SHALL BE DISCONNECTED AT THE MAIN PRIOR TO ISSUANCE OF THE CERTIFICATE OF OCCUPANCY FOR LOT 1.**
- 4. UPON COMPLETION OF ALL REMAINING PUBLIC IMPROVEMENTS FOR THE ENTIRE GREEN ACRES SUBDIVISION, THE PETITIONER SHALL SUBMIT RECORD DRAWINGS FOR APPROVAL BY THE VILLAGE COUNCIL. ALONG WITH THE RECORD DRAWINGS, THE PETITIONER SHALL SUBMIT A GUARANTEE SECURITY IN THE AMOUNT OF 20% OF THE TOTAL COST OF THE PUBLIC IMPROVEMENTS, WHICH SHALL EXPIRE NO EARLIER THAN TWO YEARS AFTER ACCEPTANCE OF SUCH PUBLIC IMPROVEMENTS BY THE VILLAGE COUNCIL.**

**SECONDED BY MR. QUIRK. ROLL CALL:**

**AYE: MRS. RABATAH, MR. QUIRK, MR. BEGGS, MR. HOSE, MR. MATEJCZYK, CHAIRMAN JIRIK**

**NAY: NONE**

**MOTION CARRIED. VOTE: 6-0**