

**VILLAGE OF DOWNERS GROVE
REPORT FOR THE VILLAGE COUNCIL MEETING
JUNE 5, 2012 AGENDA**

SUBJECT:	TYPE:	SUBMITTED BY:
Bid: 2012 Sidewalk Maintenance Program (S-006-12 & S-006-13)	Resolution Ordinance ✓ Motion Discussion Only	Nan Newlon, P.E. Director of Public Works

SYNOPSIS

A motion is requested to authorize award of the following contracts for sidewalk maintenance:

- 2012 Replacement Sidewalk Program (CIP Project S-006-12) to Mondri Construction, Inc. of Roselle, Illinois in the amount of \$130,522.50.
- 2012 Sidewalk Rehabilitation Project (S-006-12) to Safe Step LLC of Hortonville, Wisconsin in the amount of \$48,300.00.

The total project cost is \$178,822.50.

STRATEGIC PLAN ALIGNMENT

The goals for 2011-2018 identified *Top Quality Infrastructure*.

FISCAL IMPACT

The FY12 budget includes \$174,325.00 in the Capital Projects Fund for this project. The combined low bids for this project are \$4,497.50 more than the budgeted amount. Sufficient budget authority is available in the Capital Projects Fund for this project.

RECOMMENDATION

Approval on the June 12, 2012 consent agenda.

BACKGROUND

These projects provide for the replacement or rehabilitation of sidewalks with a grade difference of 1-1/8” or more (tripping hazards). This year’s Replacement Sidewalk Program will include approximately 20,000 square-feet of sidewalk replacement, intermittent curb replacement, and existing sidewalk ramps upgraded to comply with ADA standards.

This year’s program will again include a second contract which allows for costs savings by rehabilitating sidewalks instead of replacement to eliminate trip hazards. This involves cutting concrete with a special horizontal concrete saw. This work typically costs \$50 per location instead of \$150 for removal and replacement. This method of trip hazard removal exceeds ADA compliance, is cost effective, clean, and efficient. This year’s project will include approximately 900 or more locations within the village.

Bids were received on Wednesday, May 16, 2012 for each of the contracts. A synopsis of each contract bid is as follows:

S-006-12 Replacement Sidewalk Program

Contractor	Total Bid	
MONDI CONSTRUCTION	\$130,522.50	low bid
GLOBE CONSTRUCTION	\$151,617.50	

S-006-13 Sidewalk Rehabilitation Project

Contractor	Total Bid	
SAFE STEP LLC	\$48,300.00	only bid

The low bidder for the Replacement Sidewalk Program has satisfactorily performed work of similar scope for the communities of Streamwood and Evanston and has received positive references.

Safe Step LLC performed the 2011 Rehabilitation Sidewalk Program. Staff reviewed and evaluated the vendor's past performance and determined the completed work was satisfactory.

ATTACHMENTS

Contract Signature Forms

Campaign Disclosure Certificates

Contractors Evaluation Form (S-006-11)

CIP Sheet

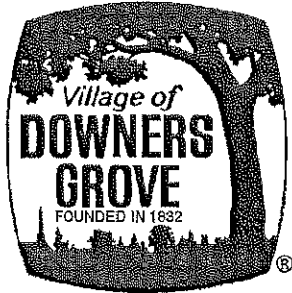

CALL FOR BIDS – FIXED WORKS PROJECT

- I. Name of Company Bidding: Mandi Construction Inc
- II. Instructions and Specifications:
- A. Bid No.: S-006-12
 - B. For: 2012 REPLACEMENT SIDEWALK PROGRAM
 - C. Bid Opening Date/Time: WEDNESDAY, MAY 16, 2012 @ 11:00 AM
 - D. Pre-Bid Conference Date/Time: N/A
 - E. Specifications available for pickup at the Public Works Facility, 5101 Walnut Downers Grove, IL. 60515.
- III. Required of All Bidders:
- A. Bid Deposit: 5%
 - B. Letter of Capability of Acquiring Performance Bond: YES
- IV. Required of Awarded Contractor(s)
- A. Performance Bond or Letter of Credit: YES
 - B. Certificate of Insurance: YES

Legal Advertisement Published: WEDNESDAY, MAY 2, 2012

This document comprises 75 pages

RETURN ORIGINAL BID IN SEALED ENVELOPE MARKED WITH THE BID NUMBER AS NOTED ABOVE TO:

BRIAN PARKS
VILLAGE OF DOWNERS GROVE
5101 WALNUT AVENUE
DOWNERS GROVE, IL 60515
PHONE: 630/434-5460
FAX: 630/434-5495
www.downers.us

CALL FOR BIDS – FIXED WORKS PROJECT

Bid No.: S-006-12

The VILLAGE OF DOWNERS GROVE will receive bids Monday thru Friday, 8:00 A.M. to 5:00 P.M. at the Public Works Building, 5101 Walnut Avenue, Downers Grove, IL 60515.

The Village Council reserves the right to accept or reject any and all bids, to waive technicalities and to accept or reject any item of any Bid.

The documents constituting component parts of this Contract are the following:

- I. CALL FOR BIDS
- II. TERMS & CONDITIONS
- III. GENERAL PROVISIONS
- IV. SPECIAL PROVISIONS
- V. BID & CONTRACT FORM

All Bidders MUST submit the entire bid package, with one original Bid Form. Upon formal Award, the successful Bid will automatically convert to a Contract, and the successful Bidder will receive a copy of the executed contract upon formal award of the Bid with the Notice of Award.

DO NOT DETACH ANY PORTION OF THIS DOCUMENT. INVALIDATION COULD RESULT.

I. CALL FOR BIDS and INSTRUCTIONS TO BIDDERS

1. GENERAL

- 1.1 Notice is hereby given that Village of Downers Grove will receive sealed bids up to:
WEDNESDAY, MAY 16, 2012 @ 11:00 AM
 - 1.2 Defined Terms:
 - 1.2.1 Village – the Village of Downers Grove acting through its officers or agents.
 - 1.2.2 Contract Documents – this document plus any drawings issued therewith, any addenda and the Bidder's completed proposal, bonds and all required certifications.
 - 1.2.3 Bid – this document completed by an individual or entity and submitted to the Village.
 - 1.2.4 Bidder – the individual or entity who submits or intends to submit a bid proposal to the Village.
 - 1.2.5 Contractor – the individual or entity whose bid is selected by the Village and who enters into a contract with the Village.
 - 1.2.6 Work – the construction or service defined herein.
 - 1.2.7 Day – unless otherwise stated all references to day "Day" "Days", "day" or "days" shall refer to calendar days.
 - 1.2.8 Proposal Guaranty – the required bid deposit.
 - 1.3 Bids must be received at the Village by the time and date specified. Bids received after the specified time and date will not be accepted and will be returned unopened to the Bidder.
 - 1.4 Bids shall be sent to the Village of Downers Grove, in a sealed envelope marked "SEALED BID". The envelope shall be marked with the name of the project, date, and time set for receipt of Bids. The bid package may be submitted any time prior to the time set for receipt of Bids.
 - 1.5 All Bids must be submitted on the forms supplied by the Village and signed by a proper official of the company submitting the Bid. Telephone, email and fax Bids will not be accepted.
 - 1.6 Under penalty of perjury, the Bidder certifies by submitting this Bid that he has not acted in collusion with any other Bidder or potential Bidder.
- ### **2. BID PREPARATION**
- 2.1 It is the responsibility of the Bidder to carefully examine the Contract Documents and to be familiar with all of the requirements, stipulations, provisions, and conditions surrounding the proposed Work.

- 2.2 The Bidder shall inspect the site of the proposed Work in detail, investigate and become familiar with all the local conditions affecting the Work and become fully acquainted with the detailed requirements of the Work. Submitting a Bid shall be a conclusive assurance and warranty that the Bidder has made these examinations and that the Bidder understands all requirements for the performance of the Work. If the Bid is accepted, the Bidder will be responsible for all errors in the Bid resulting from his willing or neglectful failure to comply with these instructions. IN NO CASE WILL THE VILLAGE BE RESPONSIBLE FOR ANY COSTS, EXPENSES, LOSSES OR CHANGES IN ANTICIPATED MARGINS OF PROFIT RESULTING FROM THE WILLING OR NEGLECTFUL FAILURE OF THE BIDDER TO MAKE THESE EXAMINATIONS. THE VILLAGE WILL NOT BE RESPONSIBLE FOR ANY COSTS, EXPENSES, LOSSES OR CHANGES IN ANTICIPATED MARGINS OF PROFIT RESULTING FROM THE WILLING OR NEGLECTFUL FAILURE OF THE CONTRACTOR TO PROVIDE THE KNOWLEDGE, EXPERIENCE AND ABILITY TO PERFORM THE WORK REQUIRED BY THIS CONTRACT. No changes in the prices, quantities or contract provisions shall be made to accommodate the inadequacies of the Bidder, which might be discovered subsequent to award of contract. The Bidder shall take no advantage of any error or omission in the Contract Documents nor shall any error or omission in the Contract Documents serve as the basis for an adjustment of the amounts paid to the Bidder.
- 2.3 When the Contract Documents include information pertaining to subsurface explorations, borings, test pits, and other preliminary investigations, such information is included solely for the convenience of the Bidder. *The Village assumes no responsibility whatsoever with respect to the sufficiency of the information, and does not warrant, neither expressly nor by implication, that the conditions indicated represent those existing throughout the Work, or that unanticipated developments may not occur.*
- 2.4 Any information shown in the Contract Documents regarding the locations of underground utility facilities is included solely for the convenience of the Bidder. The Village assumes no responsibility whatsoever with respect to the sufficiency, accuracy or inadequacy of such information. It shall be the Bidder's responsibility to obtain detailed information from the respective utility companies relating to the location of their facilities and the work schedules of the utility companies for removing or adjusting them. Utilities whose facilities may be affected by the work include, but may not be limited to, the following: Nicor, ComEd, SBC, Comcast Cable, Downers Grove Sanitary District, and Village water, storm sewer, and street lighting systems.
- 2.5 No oral or telephone interpretations of specifications shall be binding upon the Village. All requests for interpretations or clarifications shall be made in writing and received by the Village at least five (5) business days prior to the date set for receipt of Bids or the pre-bid conference, if offered. The Village shall make all changes or interpretations of the Contract Documents in a written addendum and shall provide an addendum to any Bidder of record. Any and all changes to the Contract Documents are valid only if they are included by written addendum to all Bidders. Each Bidder must acknowledge receipt of any addenda by indicating same on the Bid Form. Each Bidder, by acknowledging receipt of any addenda, is responsible for the contents of the addenda and any changes to the Bid therein. Failure to acknowledge any addenda may cause the Bid to be rejected. The Village will not assume responsibility for receipt of any addenda. In all cases, it will be the Bidder's responsibility to obtain all addenda issued. Bidders will provide written acknowledgement of receipt of each addendum issued with the bid submission.

- 2.6 An estimate of the quantities of Work to be performed and the materials to be furnished is shown in the Bid Form. It is given as a basis for comparing the properly submitted Bids, and shall be used by the Village in awarding the Contract. The Village does not expressly warrant nor imply that the estimated quantities shown will correspond with those quantities required to perform the Work. No Bidder shall plead misunderstanding or deception because of such an estimate of quantities, or because of the character, location or other conditions pertaining to the Work. Payment shall be based on the actual quantities of work properly performed in accordance with the Contract, at the Contract unit prices specified. The Village reserves the right to increase, decrease or omit entirely, any or all items. No allowance will be made for any change in anticipated profits due to an increase or decrease in the original estimate of quantities.
- 2.7 The Bidder must submit his Bid on the form furnished by the Village. The Bid shall be executed properly, and Bids shall be made for all items indicated in the Bid Form. The Bidder shall indicate, in figures, a unit price or lump sum price for each of the separate items called for in the Bid Form. The Bidder shall show the products of the respective quantities and unit prices in the column provided for that purpose. The gross sum shown in the place indicated in the Bid Form shall be the summation of said products. All writing shall be with ink or typewriter, except the signature of the Bidder, which shall be written with ink.
- 2.8 In case of error in the extension of prices in the Bid, the hourly rate or unit price will govern. In case of discrepancy in the price between the written and numerical amounts, the written amount will govern.
- 2.9 All costs incurred in the preparation, submission, and/or presentation of any Bid including the Bidder's travel or personal expenses shall be the sole responsibility of the Bidder and will not be reimbursed by the Village.
- 2.10 The Bidder hereby affirms and states that the prices quoted herein constitute the total cost to the Village for all work involved in the respective items, as well as the materials to be furnished in accordance with the collective requirements of the Contract Documents. The Bidder also affirms that this cost includes all insurance, bonds, royalties, transportation charges, use of all tools and equipment, superintendence, overhead expense, profits and other work, services and conditions necessarily involved in the work to be done.
- 2.11 The Bidder shall complete and submit with the Bid an "Affidavit" (IDOT Form BC-57, or similar) listing all uncompleted contracts, including subcontract work; all pending low bids not yet awarded or rejected, and equipment available.
- 2.12 The Bidder shall complete and submit with the Bid a "Municipal Reference List" indicating other municipalities for which the Bidder has successfully performed similar work.
- 3. PRE-BID CONFERENCE**
- 3.1 A pre-bid conference may be offered to provide additional information, inspection or review of current facilities or equipment, and to provide an open forum for questions from Bidders. This pre-bid conference is not mandatory (unless stated "Required" on the cover of this document), but attendance by Bidders is strongly advised as this will be the last opportunity to ask questions concerning the Bid.

- 3.2 Questions may be posed in writing to the Village (faxed and emailed questions are acceptable), but must be received by the Village prior to the scheduled time for the pre-bid conference. Questions received will be considered at the conference. An addendum may be issued as a result of the pre-bid conference. Such an addendum is subject to the provisions for issuance of an addendum as set forth in Section 2.5 above.
- 3.3 No Contract Documents will be issued after the pre-bid conference except to attendees.

4. BID SUBMISSION

- 4.1 An original copy of the sealed bid marked as indicated in Section 1 shall be submitted to the Village.
- 4.2 A bid deposit will be required, which shall not exceed five percent (5%) of the estimated cost of the work to be furnished. Such bid deposit shall be in the form of a bid bond, certified check, cash or money order. Checks shall be drawn upon a bank of good standing payable to the order of the Village and said deposit shall be forfeited to the Village in the event the Bidder neglects or refuses to enter into a contract and bond when required, with approved sureties, to execute the Work or furnish the material for the price mentioned in his Bid and according to the plans and specifications in case the contract shall be awarded to him.
- 4.3 Bids shall be publicly opened at the hour and place indicated above.

5. BID MODIFICATION OR WITHDRAWAL

- 5.1 A Bid that is in the possession of the Village may be altered by a letter bearing the signature or name of the person authorized for submitting a Bid, provided that it is received prior to the time and date set for the bid opening. Telephone, email or verbal alterations of a Bid will not be accepted.
- 5.2 A Bid that is in the possession of the Village may be withdrawn by the Bidder, up to the time set for the bid opening, by a letter bearing the signature or name of the person authorized for submitting Bids. Bids may not be withdrawn after the bid opening and shall remain valid for a period of ninety (90) days from the date set for the bid opening, unless otherwise specified.
- 5.3 Any Bidder who does not submit a Bid is requested to return the enclosed Statement of "No Bid" postcard. Bidders not submitting Bids or "No Bid Statement" may otherwise be removed from the Village's bid mailing list.

6. BID REJECTION

- 6.1 Bids that contain omissions, erasures, alterations, additions not called for, conditional bids or alternate bids not called for, or irregularities of any kind, shall be rejected as informal or insufficient. Bids otherwise acceptable, which are not accompanied by the proper Proposal Guaranty, shall also be rejected as informal or insufficient. The Village reserves the right however, to reject any or all Bids and to waive such technical error as may be deemed best for the interest of the Village.

7. BIDDER COMPETENCY

7.1 No Bid will be accepted from or contract awarded to any person, firm or corporation that is in arrears or is in default upon any debt or contract. The Bidder, if requested, must present evidence to the Village of ability and possession of necessary facilities, and financial resources to comply with the terms of the Contract Documents. Evidence must be presented within three (3) business days.

8. BIDDER DISQUALIFICATION

8.1 Any one or more of the following causes may be considered as sufficient for the disqualification of a Bidder and the rejection of their Bid.

8.1.1 More than one Bid for the same Work from an individual, firm partnership, or corporation under the same or different names.

8.1.2 Evidence of collusion among Bidders.

8.1.3 Unbalanced Bids in which the prices for some items are substantially out of proportion to the prices for other items.

8.1.4 Failure to submit a unit price for each item of Work listed in the Bid Form.

8.1.5 Lack of competency as revealed by financial statement or experience questionnaire.

8.1.6 Unsatisfactory performance record as shown by past work, judged from the standpoint of workmanship and progress.

8.1.7 Uncompleted work which, in the judgment of the Village, might hinder or prevent the prompt completion of this Work.

8.1.8 Failure to submit a signed Bidder's Certificate stating the following:

8.1.8.1 That the Bidder is not barred from bidding on this Contract as a result of a violation of Sections 720 ILCS 5/33-E3 and 720 ILCS 5/33-E4 of the Illinois Compiled Statutes; and

8.1.8.2 The Bidder is not delinquent in the payment of any tax administered by the Illinois Department of Revenue; and

8.1.8.3 The Bidder will maintain the types and levels of insurance required by the terms of this contract; and

8.1.8.4 The Bidder will comply with the Illinois Prevailing Wage Act, 820 ILCS 130/1 *et seq.*

9. BASIS OF AWARD

9.1 The Village reserves the exclusive right to accept or reject any and all Bids or to waive sections, technicalities and irregularities, or to accept or reject any Bid or any item of any Bid.

10. AWARD OF CONTRACT

10.1 Unless the Village exercises its right to reject all Bids, the Contract will be awarded to that responsible Bidder whose Bid, conforming to the Contract Documents, will be most advantageous to the Village, price and other factors considered. (the credentials, financial information, bonding capacity, insurance protection, qualifications of the labor and management of the firm, past experience and ability to complete the project within time frame required - lowest responsible bidder)

10.2 Unless otherwise specified, if a Contract is not awarded within ninety (90) days after the opening of Bids, a Bidder may file a written request with the Village for the withdrawal of their Bid. The Village will have a maximum of ten (10) days after the receipt of such request to award the Contract or release the Bidder from further obligation by return of the Bidder's bid deposit. Any attempt or actual withdrawal or cancellation of a Bid by the awarded contractor who has been notified by the Village of the acceptance of said Bid shall be considered a breach of contract.

11. RETURN OF BID DEPOSIT

11.1 The bid deposit of all except the three (3) lowest responsive bidders on each contract will be returned within fifteen (15) days after the opening of Bids. The remaining bid deposits of each contractor will be returned within fifteen (15) days after the Village Council has awarded the contract and the required appurtenances to the contract have been received.

12. FAILURE TO ENTER INTO CONTRACT

12.1 Failure on the part of the successful Bidder to execute a Contract and provide acceptable bonds, as provided herein, within ten (10) days from the date of receipt of the Contract and Notice of Award from the Village, will be considered as just cause for the revocation of the award. The Bidder's bid security shall then be forfeited to the Village, not as a penalty but in payment of liquidated damages sustained as a result of such failure.

12.2 The Bidder shall not be allowed to claim lack of receipt where the Contract and Notice of Award was mailed by U.S. Postal Services certified mail to the business address listed in his Bid. In case the Village does not receive evidence of receipt within ten (10) days of the date of Notice of Award, the Village may revoke the award. The Bidder shall then forfeit the bid security to the Village, not as a penalty but in payment of liquidated damages sustained as the result of such failure to execute the Contract.

12.3 By submitting a Bid, the Bidder understands and agrees that, if his Bid is accepted, and he fails to enter into a contract forthwith, he shall be liable to the Village for any damages the Village may thereby suffer.

13. SECURITY FOR PERFORMANCE

13.1 The successful Bidder shall, within ten (10) days after acceptance of the Bidder's Bid by the Village, furnish a Performance Bond and a Materials and Labor Payment Bond acceptable to the Village in the full amount of the Bid. Said bonds shall guarantee the Bidder's performance under the Contract Documents and shall guarantee payment of all subcontractors and material suppliers. Any bond shall include a provision as will guarantee faithful performance of the Illinois Prevailing Wage Act, 820 ILCS 130/1 et seq.

14. TAX EXEMPTION

- 14.1 The Village is exempt from Illinois sales or use tax for direct purchases of materials and supplies. A copy of the Illinois Sales Tax Exemption Form will be issued upon request. The Village's federal identification number will also be provided to the selected Bidder.

15. RESERVED RIGHTS

- 15.1 The Village reserves the right to waive sections, irregularities, technicalities and informalities to this Contract and to accept any Bid and to reject any and all Bids and to disapprove of any and all subcontractors as may be in the best interest of the Village. Time and date requirements for receipt of Bids, however, will not be waived.

16. CATALOGS AND SHOP DRAWINGS

- 16.1 Each Bidder shall submit catalogs, descriptive literature, and detailed drawings, where applicable, to fully illustrate and describe the work or material he proposes to furnish.

17. TRADE NAMES AND SUBSTITUTIONS

- 17.1 Certain materials and equipment are specified by a manufacturer or trade name to establish standards or quality and performance and not for the purpose of limiting competition. Products of other manufacturers may be substituted, if, in the opinion of the Village, they are equal to those specified in quality, performance, design, and suitability for intended use. If the Bidder proposes to furnish an "equal", the proposed "equal" item must be so indicated in the written Bid. Where two or more items are specified, the selection among those specified is the Bidder's option, or he may submit his Bid on all such items. Detail specification sheets shall be provided by Bidder for all substituted items.

II. TERMS AND CONDITIONS

18. VILLAGE ORDINANCES

- 18.1 The successful Bidder, now the Contractor, will strictly comply with all ordinances of the Village of Downers Grove and laws of the State of Illinois.

19. USE OF VILLAGE'S NAME

- 19.1 The Contractor is specifically denied the right of using in any form or medium the name of the Village for public advertising unless the Village grants express permission.

20. HOURS OF WORK

- 20.1 The Contractor shall do no work between the hours of 7:00 p.m. and 7:00 a.m., nor on Saturdays, Sundays or legal holidays, unless otherwise approved in writing by the Village. However, such work may be performed at any time if necessary, for the proper care and protection of work already performed, or in case of an emergency. All after-hour work is still subject to the permission of the Village.

21. PERMITS AND LICENSES

- 21.1 The Contractor shall obtain all necessary permits and licenses required to complete the Work.

The cost of acquisition of all necessary permits, bonds, insurance and services as specified herein shall be considered INCIDENTAL, and no additional compensation will be allowed the Contractor.

22. INSPECTION

22.1 The Village shall have a right to inspect, by its authorized representative, any material, components or workmanship as herein specified. Materials, components or workmanship that have been rejected by the Village as not in accordance with the terms of the contract specifications shall be replaced by the Contractor at no cost to the Village.

23. DELIVERIES

23.1 All materials shipped to the Village must be shipped F.O.B. designated location, Downers Grove, Illinois.

24. SPECIAL HANDLING

24.1 Prior to delivery of any product that is caustic, corrosive, flammable or dangerous to handle, the Contractor will provide written directions as to methods of handling such products, as well as the antidote or neutralizing material required for its first aid before delivery. Contractor shall also notify the Village and provide material safety data sheets for all substances used in connection with this Contract which are defined as toxic under the Illinois Toxic Substances Disclosure to Employees Act.

25. NONDISCRIMINATION

25.1 Contractor shall, as a party to a public contract:

25.1.1 Refrain from unlawful discrimination in employment and undertake affirmative action to assure equality of employment opportunity and eliminate the effects of past discrimination;

25.1.2 By submission of this Bid, the Contractor certifies that he is an "equal opportunity employer" as defined by Section 2000(e) of Chapter 21, Title 42, U.S. Code Annotated and Executive Orders #11246 and #11375, which are incorporated herein by reference. The Equal Opportunity clause, Section 6.1 of the Rules and Regulations of the Department of Human Rights of the State of Illinois, is a material part of any contract awarded on the basis of this Bid.

25.2 It is unlawful to discriminate on the basis of race, color, sex, national origin, ancestry, age, marital status, physical or mental handicap or unfavorable discharge for military service. Contractor shall comply with standards set forth in Title VII of the Civil Rights Act of 1964, 42 U.S.C. Secs. 2000 et seq., The Human Rights Act of the State of Illinois, 775 ILCS 5/1-101 et. seq, and The Americans With Disabilities Act, 42 U.S.C. Secs. 12101 et. seq.

26. SEXUAL HARASSMENT POLICY

26.1 The Contractor, as a party to a public contract, shall have a written sexual harassment policy that:

26.1.1 Notes the illegality of sexual harassment;

- 26.1.2 Sets forth the State law definition of sexual harassment;
- 26.1.3 Describes sexual harassment utilizing examples;
- 26.1.4 Describes the Contractor's internal complaint process including penalties;
- 26.1.5 Describes the legal recourse, investigative and complaint process available through the Illinois Department of Human Rights and the Human Rights Commission and how to contact these entities; and
- 26.1.6 Describes the protection against retaliation afforded under the Illinois Human Rights Act.

27. EQUAL EMPLOYMENT OPPORTUNITY

27.1 In the event of the Contractor's non-compliance with the provisions of this Equal Employment Opportunity Clause, the Illinois Human Rights Act or the Rules and Regulations of the Illinois Department of Human Rights ("Department"), the Contractor may be declared ineligible for future contracts or subcontracts with the State of Illinois or any of its political subdivisions or municipal corporations, and the contract may be canceled or voided in whole or in part, and such other sanctions or penalties may be imposed or remedies invoked as provided by statute or regulation. During the performance of this Contract, the Contractor agrees as follows:

- 27.1.1 That it will not discriminate against any employee or applicant for employment because of race, color, religion, sex, marital status, national origin or ancestry, age, physical or mental disability unrelated to ability, military status, order of protection status, sexual orientation, sexual identity, or an unfavorable discharge from military service; and further that it will examine all job classifications to determine if minority persons or women are underutilized and will take appropriate affirmative action to rectify any such underutilization.
- 27.1.2 That, if it hires additional employees in order to perform this Contract or any portion thereof, it will determine the availability (in accordance with the Department's Rules and Regulations) of minorities and women in the area(s) from which it may reasonably recruit and it will hire for each job classification for which employees are hired in such a way that minorities and women are not underutilized.
- 27.1.3 That, in all solicitations or advertisements for employees placed by it or on its behalf, it will state that all applicants will be afforded equal opportunity without discrimination because of race, color, religion, sex, marital status, national origin or ancestry, age, physical or mental disability unrelated to ability, military status, order of protection status, sexual orientation, or an unfavorable discharge from military services.
- 27.1.4 That it will send to each labor organization or representative of workers with which it has or is bound by a collective bargaining or other agreement or understanding, a notice advising such labor organization or representative of the Contractor's obligations under the Illinois Human Rights Act and the Department's Rules and Regulations.

If any such labor organization or representative fails or refuses to cooperate with the Contractor in its efforts to comply with such Act and Rules and Regulations, the Contractor will promptly so notify the Department and the contracting agency and will recruit employees from other sources when necessary to fulfill its obligations thereunder.

- 27.1.5 That it will submit reports as required by the Department's Rules and Regulations, furnish all relevant information as may from time to time be requested by the Department or the contracting agency, and in all respects comply with the Illinois Human Rights Act and the Department's Rules and Regulations.
- 27.1.6 That it will permit access to all relevant books, records, accounts and work sites by personnel of the contracting agency and the Department for purpose of investigation to ascertain compliance with the Illinois Human Rights Act and the Department's Rules and Regulations.
- 27.1.7 That it will include verbatim or by reference the provisions of this clause in every subcontract it awards under which any portion of the contract obligations are undertaken or assumed, so that such provisions will be binding upon such subcontractor. In the same manner as with other provisions of this Contract, the Contractor will be liable for compliance with applicable provisions of this clause by such subcontractors; and further it will promptly notify the contracting agency and the Department in the event any subcontractor fails or refuses to comply therewith. In addition, the Contractor will not utilize any subcontractor declared by the Illinois Human Rights Commission to be ineligible for contracts or subcontracts with the State of Illinois or any of its political subdivision or municipal corporations.

28. DRUG FREE WORK PLACE

28.1 Contractor, as a party to a public contract, certifies and agrees that it will provide a drug free workplace by:

28.1.1 Publishing a statement:

(1) Notifying employees that the unlawful manufacture, distribution, dispensation, possession or use of a controlled substance, including cannabis, is prohibited in the Village's or Contractor's workplace.

(2) Specifying the actions that will be taken against employees for violations of such prohibition.

(3) Notifying the employee that, as a condition of employment on such contract or grant, the employee will:

(A) abide by the terms of the statement; and

(B) notify the employer of any criminal drug statute conviction for a violation occurring in the workplace no later than five (5) days after such conviction.

28.1.2 Establishing a drug free awareness program to inform employees about:

(1) the dangers of drug abuse in the workplace;

(2) the Village's or Contractor's policy of maintaining a drug free workplace;

(3) any available drug counseling, rehabilitation and employee assistance programs;

(4) the penalties that may be imposed upon employees for drug violations.

- 28.1.3 Providing a copy of the statement required by subparagraph 1.1 to each employee engaged in the performance of the contract or grant and to post the statement in a prominent place in the workplace.
- 28.1.4 Notifying the contracting or granting agency within ten (10) days after receiving notice under part (3)(B) of subparagraph 1.1 above from an employee or otherwise receiving actual notice of such conviction.
- 28.1.5 Imposing a sanction on, or requiring the satisfactory participation in a drug abuse assistance or rehabilitation program by, any employee who is so convicted as required by section 5 of the Drug Free Workplace Act.
- 28.1.6 Assisting employees in selecting a course of action in the event drug counseling, treatment and rehabilitation is required and indicating that a trained referral team is in place.
- 28.1.7 Making a good faith effort to continue to maintain a drug free workplace through implementation of the Drug Free Workplace Act.

29. SUBSTANCE ABUSE PREVENTION ON PUBLIC WORKS PROJECTS ACT

- 29.1 In the event this is a public works project as defined under the Prevailing Wage Act, 820 ILCS 130/2, Contractor agrees to comply with the Substance Abuse Prevention on Public Works Projects Act, 820 ILCS 265/1 *et seq.*, and further agrees that all of its subcontractors shall comply with such Act. As required by the Act, Contractor agrees that it will file with the Village prior to commencing work its written substance abuse prevention program and/or that of its subcontractor(s) which meet or exceed the requirements of the Act.

30. PREVAILING WAGE ACT

- 30.1 Contractor agrees to comply with the Illinois Prevailing Wage Act, 820 ILCS 130/1 *et seq.*, for all work completed under this Contract. Contractor agrees to pay the prevailing wage and require that all of its subcontractors pay prevailing wage to any laborers, workers or mechanics who perform work pursuant to this Contract or related subcontract. For applicable rates, go to the State of Illinois – Department of Labor website and use the most current DuPage County rate.
- 30.2 Contractor and each subcontractor shall keep or cause to be kept an accurate record of names, occupations and actual wages paid to each laborer, workman and mechanic employed by the Contractor in connection with the contract. This record shall be open to inspection at all reasonable hours by any representative of the Village or the Illinois Department of Labor and must be preserved for four (4) years following completion of the contract.
- 30.3 Since this is a contract for a public works project, as defined in 820 ILCS 130/2, Contractor agrees to post at the job site in an easily accessible place, the prevailing wages for each craft or type of worker or mechanic needed to execute the contract or work to be performed.
- 30.4 Because this is a public works project as defined under the Prevailing Wage Act, 820 ILCS 130/2, any and all contractors and subcontractors shall submit certified payroll records to the Village no later than the tenth (10th) day of each calendar month for the immediately preceding month in which construction on a public works project has occurred.

WITHOUT THIS PAPERWORK, NO INVOICE SHALL BE PAID BY THE VILLAGE. Contractors and subcontractors must also submit a statement affirming that the records are true and accurate, that the wages paid to each worker are not less than the prevailing rate, and that the contractor and subcontractor are aware that filing false records is a Class A misdemeanor. The records must include the name, address, telephone number, social security number, job classification, hours of work, hourly rate, and start and end time of work each day for every worker employed on the public work. The Village reserves the right to check the pay stubs of the workers on the job. The Village further cautions that payment for any services rendered pursuant to this Contract may be predicated upon receipt of said records.

- 30.5 In the event that this is a construction project where Motor Fuel tax monies or state grant monies are used in the construction, maintenance and extension of municipal streets, traffic control signals, street lighting systems, storm sewers, pedestrian subways or overhead crossings, sidewalks and off-street parking facilities, and the like, the Village will require an Apprenticeship and Training Certification, attached after the Bidder's Certification.
- 30.6 Any bond furnished as security for performance shall include a provision as will guarantee faithful performance of the Illinois Prevailing Wage Act, 820 ILCS 130/1 et seq.

31. PATRIOT ACT COMPLIANCE

- 31.1 The Contractor represents and warrants to the Village that neither it nor any of its principals, shareholders, members, partners, or affiliates, as applicable, is a person or entity named as a Specially Designated National and Blocked Person (as defined in Presidential Executive Order 13224) and that it is not acting, directly or indirectly, for or on behalf of a Specially Designated National and Blocked Person. The Contractor further represents and warrants to the Village that the it and its principals, shareholders, members, partners, or affiliates, as applicable are not, directly or indirectly, engaged in, and are not facilitating, the transactions contemplated by this Contract on behalf of any person or entity named as a Specially Designated National and Blocked Person. The Contractor hereby agrees to defend, indemnify and hold harmless the Village, and its elected or appointed officers, employees, agents, representatives, engineers and attorneys, from and against any and all claims, damages, losses, risks, liabilities and expenses (including reasonable attorney's fees and costs) arising from or related to any breach of the foregoing representations and warranties.

32. INSURANCE REQUIREMENTS

- 32.1 Prior to starting the Work, Contractor and any Subcontractors shall procure, maintain and pay for such insurance as will protect against claims for bodily injury or death, or for damage to property, including loss of use, which may arise out of operations by the Contractor or Subcontractor or any Sub-Sub Contractor or by anyone employed by any of them, or by anyone for whose acts any of them may be liable. Such insurance shall not be less than the greater of coverages and limits of liability specified below or any coverages and limits of liability specified in the Contract Documents or coverages and limits required by law unless otherwise agreed to by the Village.

Workers Compensation	\$500,000	Statutory
Employers Liability	\$1,000,000	Each Accident
	\$1,000,000	Disease Policy Limit
	\$1,000,000	Disease Each Employee
Comprehensive General Liability	\$2,000,000	Each Occurrence
	\$2,000,000	Aggregate
		<i>(Applicable on a Per Project Basis)</i>
Commercial Automobile Liability	\$1,000,000	Each Accident
Professional Errors & Omissions (pursuant to section 32.9 below)	\$2,000,000	Each Claim
	\$2,000,000	Annual Aggregate
Umbrella Liability	\$ 5,000,000	

- 32.2 Comprehensive General Liability Insurance required under this paragraph shall be written on an occurrence form and shall include coverage for Products/Completed Operations, Personal Injury with Employment Exclusion (if any) deleted, Blanket XCU and Blanket Contractual Liability insurance applicable to defense and indemnity obligations and other contractual indemnity assumed under the Contract Documents. The limit must be on a "Per Project Basis".
- 32.3 Commercial Automobile Liability Insurance required under this paragraph shall include coverage for all owned, hired and non-owned automobiles.
- 32.4 Workers Compensation coverage shall include a waiver of subrogation against the Village.
- 32.5 Comprehensive General Liability, Employers Liability and Commercial Automobile Liability Insurance may be arranged under single policies for full minimum limits required, or by a combination of underlying policies with the balance provided by Umbrella and/or Excess Liability policies.
- 32.6 Contractor and all Subcontractors shall have their respective Comprehensive General Liability (including products/completed operations coverage), Employers Liability, Commercial Automobile Liability, and Umbrella/Excess Liability policies endorsed to add the "Village of Downers, its officers, officials, employees and volunteers" as "additional insureds" with respect to liability arising out of operations performed; claims for bodily injury or death brought against the Village by any Contractor or Subcontractor employees, or the employees of Subcontractor's subcontractors of any tier, however caused, related to the performance of operations under the Contract Documents. Such insurance afforded to the Village shall be endorsed to provide that the insurance provided under each policy shall be *Primary and Non-Contributory*.

- 32.7 Contractor and all Subcontractors shall maintain in effect all insurance coverages required by the Contract Documents at their sole expense and with insurance carriers licensed to do business in the State of Illinois and having a current A. M. Best rating of no less than A- VIII. In the event that the Contractor or any Subcontractor fails to procure or maintain any insurance required by the Contract Documents, the Village may, at its option, purchase such coverage and deduct the cost thereof from any monies due to the Contractor or Subcontractor, or withhold funds in an amount sufficient to protect the Village, or terminate this Contract pursuant to its terms.
- 32.8 All insurance policies shall contain a provision that coverages and limits afforded hereunder shall not be canceled, materially changed, non-renewed or restrictive modifications added, without thirty (30) days prior written notice to the Village. Renewal certificates shall be provided to the Village not less than five (5) days prior to the expiration date of any of the required policies. All Certificates of Insurance shall be in a form acceptable to the Village and shall provide satisfactory evidence of compliance with all insurance requirements. The Village shall not be obligated to review such certificates or other evidence of insurance, or to advise Contractor or Subcontractor of any deficiencies in such documents, and receipt thereof shall not relieve the Contractor or Subcontractor from, nor be deemed a waiver of the right to enforce the terms of the obligations hereunder. The Village shall have the right to examine any policy required and evidenced on the Certificate of Insurance.
- 32.9 If the Work under the Contract Documents includes design, consultation, or any other professional services, Contractor or the Subcontractor shall procure, maintain, and pay for Professional Errors and Omissions insurance with limits of not less than \$2,000,000 per claim and \$2,000,000 annual aggregate. If such insurance is written on a claim made basis, the retrospective date shall be prior to the start of the Work under the Contract Documents. Contractor and all Subcontractors agree to maintain such coverage for three (3) years after final acceptance of the Project by the Village or such longer period as the Contract Documents may require. Renewal policies during this period shall maintain the same retroactive date.
- 32.10 Any deductibles or self-insured retentions shall be the sole responsibility of the Insured. At the option of the Village, either: the insurer shall reduce or eliminate such deductibles or self-insured retentions as respects the Village, its officers, officials, employees and volunteers; or the Contractor shall procure a bond guaranteeing payment of losses and related investigations, claim administration and defense expenses.

33. INDEMNITY AND HOLD HARMLESS AGREEMENT

- 33.1 To the fullest extent permitted by law, the Contractor shall indemnify, keep and save harmless the Village and its agents, officers, and employees, against all injuries, deaths, strikes, losses, damages, claims, suits, liabilities, judgments, costs and expenses, which may arise directly or indirectly from any negligence or from the reckless or willful misconduct of the Contractor, its employees, or its subcontractors.
- 33.2 The Contractor shall at its own expense, appear, defend and pay all charges of attorneys and all costs and other expenses arising therefrom or incurred in connection therewith, and, if any judgment shall be rendered against the Village in any such action, the Contractor shall, at its own expense, satisfy and discharge the same. This agreement shall not be construed as requiring the Contractor to indemnify the Village for its own negligence.

The Contractor shall indemnify, keep and save harmless the Village only where a loss was caused by the negligent, willful or reckless acts or omissions of the Contractor, its employees, or its subcontractors.

34. SUBLETTING OF CONTRACT

34.1 No contract awarded by the Village shall be assigned or any part subcontracted without the written consent of the Village. In no case shall such consent relieve the Contractor from his obligation or change the terms of this Contract.

All approved subcontracts shall contain language which incorporates the terms and conditions of this Contract.

35. TERMINATION OF CONTRACT

35.1 The Village reserves the right to terminate the whole or any part of this Contract, upon written notice to the Contractor, for any reason.

35.2 The Village further reserves the right to terminate the whole or any part of this Contract, upon ten (10) days' written notice to the Contractor, in the event of default by the Contractor. Default is defined as failure of the Contractor to perform any of the provisions of this Contract or failure to make sufficient progress so as to endanger performance of this Contract in accordance with its terms.

In the event that the Contractor fails to cure the default upon notice, and the Village declares default and termination, the Village may procure, upon such terms and in such manner as it may deem appropriate, supplies or services similar to those so terminated. The Village may also contact the issuer of the Performance Bond to complete the Work. The Contractor shall be liable for any excess costs for such similar supplies or services. Any such excess costs incurred by the Village may be set-off against any monies due and owing by the Village to the Contractor.

36. BILLING AND PAYMENT PROCEDURES

36.1 Payment will be made upon receipt of an invoice referencing Village purchase order number. Once an invoice and receipt of materials or service have been verified, the invoice will be processed for payment in accordance with the Village's payment schedule. The Village will comply with the Local Government Prompt Payment Act, 50 ILCS 505/1 et seq., in that any bill approved for payment must be paid or the payment issued to the Contractor within 60 days of receipt of a proper bill or invoice. If payment is not issued to the Contractor within this 60 day period, an interest penalty of 1.0% of any amount approved and unpaid shall be added for each month or fraction thereof after the end of this 60 day period, until final payment is made.

36.2 The Village shall review each bill or invoice in a timely manner after its receipt. If the Village determines that the bill or invoice contains a defect making it unable to process the payment request, the Village shall notify the Contractor as soon as possible after discovering the defect pursuant to rules promulgated under 50 ILCS 505/1 et seq. The notice shall identify the defect and any additional information necessary to correct it.

- 36.3 As this Contract is for work defined as a "fixed public work" project under the Illinois Prevailing Wage Act, 820 ILCS 130/2, any contractor or subcontractor is required to submit certified payroll records along with the invoice. No invoice shall be paid without said records.
- 36.4 Please send all invoices to the attention of: Village of Downers Grove, Accounts Payable, 801 Burlington, Downers Grove, IL 60515.
- 37. COMPLIANCE WITH OSHA STANDARDS**
- 37.1 Equipment supplied to the Village must comply with all requirements and standards as specified by the Occupational Safety and Health Act. All guards and protectors as well as appropriate markings will be in place before delivery. Items not meeting any OSHA specifications will be refused.
- 38. CERCLA INDEMNIFICATION**
- 38.1 The Contractor shall, to the maximum extent permitted by law, indemnify, defend, and hold harmless the Village, its officers, employees, agents, and attorneys from and against any and all liability, including without limitation, costs of response, removal, remediation, investigation, property damage, personal injury, damage to natural resources, health assessments, health settlements, attorneys' fees, and other related transaction costs arising under the Comprehensive Environmental Response, Compensation, and Liability Act (CERCLA) of 1980, 42 U.S.C.A. Sec. 9601, *et seq.*, as amended, and all other applicable statutes, regulations, ordinances, and under common law for any release or threatened release of the waste material collected by the Contractor, both before and after its disposal.
- 38.2 If the Contractor encounters any waste material governed by the above Act, it shall immediately notify the Village and stop working in the area until the above requirements can be met.
- 39. COPYRIGHT or PATENT INFRINGEMENT**
- 39.1 The Contractor agrees to indemnify, defend, and hold harmless the Village against any suit, claim, or proceeding brought against the Village for alleged use of any equipment, systems, or services provided by the Contractor that constitutes a misuse of any proprietary or trade secret information or an infringement of any patent or copyright.
- 40. BUY AMERICA**
- 40.1 The Contractor agrees to comply with 49 U.S.C.5323(j), the Federal Transportation Administration's (FTA) Buy America regulations at 49 C.F.R. Part 661, and any amendments thereto, and any implementing guidance issued by the FTA, with respect to this Contract, when financed by Federal funds (through a grant agreement or cooperative agreement).
- 40.2 As a condition of responsiveness, the Contractor agrees to submit with its Bid submission, an executed Buy America Certificate, attached hereto.
- 41. CAMPAIGN DISCLOSURE**
- 41.1 Any contractor, proposer, bidder or vendor who responds by submitting a bid or proposal to the Village of Downers Grove shall be required to submit with its bid submission, an executed Campaign Disclosure Certificate, attached hereto.

41.2 The Campaign Disclosure Certificate is required pursuant to the Village of Downers Grove Council Policy on Ethical Standards and is applicable to those campaign contributions made to any member of the Village Council.

41.3 Said Campaign Disclosure Certificate requires any individual or entity bidding to disclose campaign contributions, as defined in Section 9-1.4 of the Election Code (10 ILCS 5/9-1.4), made to current members of the Village Council within the five (5) year period preceding the date of the bid or proposal release.

41.4 By signing the bid documents, contractor/proposer/bidder/vendor agrees to refrain from making any campaign contributions as defined in Section 9-1.4 of the Election Code (10 ILCS 5/9-1.4) to any Village Council member and any challengers seeking to serve as a member of the Downers Grove Village Council.

42. GUARANTEE PERIOD

42.1 The Contractor shall provide a guarantee in writing covering a minimum period of one (1) year after approval and acceptance of the Work. The Guarantee shall be in such form as the Village may prescribe, unless otherwise noted in the Specifications, and shall be submitted before receiving final payment. If longer guarantees are required, they will be noted in the Special Provisions for this project.

43. SUCCESSORS AND ASSIGNS

43.1 The terms of this Contract will be binding upon and inure to the benefit of the parties and their respective successors and assigns; provided, however, that neither party will assign this Contract in whole or in part without the prior written approval of the other. The Contractor will provide a list of key staff, titles, responsibilities, and contact information to include all expected subcontractors.

44. WAIVER OF BREACH OF CONTRACT

44.1 The waiver by one party of any breach of this Contract or the failure of one party to enforce at any time, or for any period of time, any of the provisions hereof will be limited to the particular instance and will not operate or be deemed to waive any future breaches of this Contract and will not be construed to be a waiver of any provision except for the particular instance.

45. CHANGE ORDERS

45.1 The contract price is a "not-to-exceed" cost. At any time additional work is necessary or requested, and the not-to-exceed price is increased thereby, all parties must agree to any change, addition or price increase in writing.

45.2 Change orders for public works projects which authorize an increase in the contract price that is 50% or more of the original contract price or that authorize or necessitate any increase in the price of a subcontract under the contract that is 50% or more of the original subcontract price must be resubmitted for bidding in the same manner by which the original contract was bid. (50 ILCS 525/1)

46. SEVERABILITY OF INVALID PROVISIONS

46.1 If any provisions of this Contract are held to contravene or be invalid under the laws of any state, country or jurisdiction, contravention will not invalidate the entire Contract, but it will be construed as if not containing the invalid provision and the rights or obligations of the parties will be construed and enforced accordingly.

47. GOVERNING LAW

47.1 This Contract will be governed by and construed in accordance with the laws of the State of Illinois. Venue is proper only in the County of DuPage for state cases or the Northern District of Illinois for federal cases.

48. NOTICE

48.1 Any notice will be in writing and will be deemed to be effectively served when deposited in the mail with sufficient first class postage affixed, and addressed to the party at the party's place of business. Notices shall be addressed to the Village as follows:

**Village Manager
Village of Downers Grove
801 Burlington Ave.
Downers Grove, IL 60515**

And to the Contractor as designated on the Contract Form.

49. AMENDMENT

49.1 This Contract will not be subject to amendment unless made in writing and signed by all parties.

50. COOPERATION WITH FOIA COMPLIANCE

50.1 Contractor acknowledges that the Freedom of Information Act may apply to public records in possession of the Contractor or a subcontractor. Contractor and all of its subcontractors shall cooperate with the Village in its efforts to comply with the Freedom of Information Act. 5 ILCS 140/1 et.seq.

51. EMPLOYMENT OF ILLINOIS WORKERS ON PUBLIC WORKS ACT

51.1 If the work contemplated by this Contract is funded or financed in whole or in part with State Funds or funds administered by the State, Contractor agrees to comply with the terms of the Employment of Illinois Workers on Public Works Act by employing at least 90% Illinois laborers on the project. 30 ILCS 570/1 et seq. Contractor agrees further to require compliance with this Act by all of its subcontractors.

III. GENERAL PROVISIONS

1. STANDARD SPECIFICATIONS

- 1.1 The following standards shall govern the construction of the proposed improvements:
 - 1.1.1 Standard Specifications for Water and Sewer Main Construction in Illinois, Sixth Edition, 2009 (the Water & Sewer Specs.); and
 - 1.1.2 Standard Specifications for Road and Bridge Construction as adopted by the Illinois Department of Transportation, January 1, 2012; along with Supplemental Specifications and Recurring Special Provisions (collectively the "SSRBC") as adopted by the Illinois Department of Transportation, January 1, 2012; and
 - 1.1.3 Water Distribution Specifications, Village of Downers Grove, Illinois, revised March, 2006.
- 1.2 These Contract Documents shall take precedence whenever there are conflicts in the wording or statements made by the above specifications and these Contract Documents.
- 1.3 Unless otherwise referenced herein, Division I of the Water and Sewer Specs and Section 102 and Articles 104.02, 104.03, 104.07, 107.02, 107.27, 107.35, 108.10, 108.11, and 108.12 of the SSRBC are hereby suspended.

2. COOPERATION OF CONTRACTOR

- 2.1 The Contractor will be supplied with a minimum of 2 sets of approved plans and contract assemblies including Special Provisions, one set of which the Contractor shall keep available on the work site at all times. The Contractor shall give the work site constant attention necessary to facilitate the progress thereof, and shall cooperate with the Village in every way possible.
- 2.2 The Contractor shall have on the work site at all times, as the Contractor's agent, a competent English-speaking representative capable of reading and thoroughly understanding the Contract Documents, and thoroughly experienced in the type of work being performed. The representative shall also be capable of receiving instruction from the Village, and shall have full authority to promptly respond to such instruction. He shall be capable of supplying such materials, equipment, tools, labor and incidentals as may be required. The Contractor shall not replace him without prior written notification to the Village.

3. LEGAL REGULATIONS AND RESPONSIBILITY TO THE PUBLIC

- 3.1 Section 107 of the SSRBC shall govern the Contractor's legal regulations and responsibility to the public, with the following additions:
 - 3.1.1 PROJECT SAFETY. Add the following to Article 107.28:
 - 3.1.1.1 The Contractor shall conduct his work in such a manner as to provide an environment consistent with the safety, health and well being of those engaged in the completion of the Work specified in this Contract.

- 3.1.1.2 The Contractor shall comply with all State and Federal Safety Regulations as outlined in the latest revisions of the Federal Construction Safety Standards (Series 1926) and with applicable provisions and/or regulations of the Occupation Safety and Health Administration (OSHA) and Standards of the Williams-Stelger Occupational Health Safety Act of 1970 (Revised). SPECIAL ATTENTION SHALL BE PAID TO COMPLIANCE WITH OSHA'S SUBPART P – EXCAVATIONS STANDARD.
- 3.1.1.3 The Contractor and Village shall each be responsible for their own respective agents and employees.
- 3.1.2 **BACKING PRECAUTIONS.** Pursuant to Sections 14-139(b) and 14-171.1 of the Downers Grove Municipal Code, any motor vehicle which has an obstructed view to the rear and is to be operated at any time in reverse gear on the public streets of the Village by the Contractor or any subcontractor shall either be equipped with a reverse signal alarm (backup alarm) audible above and distinguishable from the surrounding noise level, or shall provide an observer to signal that it is safe to back up.
- 3.1.3 **OVERWEIGHT, OVERWIDTH AND OVERHEIGHT PERMITS.** The Village has and supports an overweight truck enforcement program. Contractors are required to comply with weight requirements and safety requirements as established by Illinois Law or Village Ordinance, for vehicles, vehicle operators and specialty equipment. In some instances, specialty equipment for road repairs or construction projects requires the movement of overweight, overwidth, or overheight loads utilizing a Village roadway. Such movement will require obtaining a permit from the Village Police Department's Traffic Supervisor.
- 3.1.4 **BARRICADES AND WARNING SIGNS.** The Contractor shall provide the Village with a telephone number of a person or company who is available 24 hours per day, seven days per week, to erect additional barricades or signs. If the Village or its representative deems it necessary for the Public's safety to erect additional barricades or signs during normal working hours, the Contractor will furnish the necessary barricades or signs, and have them in place within 30 minutes. If, after normal working hours, the requested signs are not in place within three hours after the request is made, the Village reserves the right to have the barricades and signs erected. The cost of erecting the barricades and signs shall be deducted by the Village from any payments due the Contractor.

4. PROSECUTION AND PROGRESS

4.1 Section 108 of the SSRBC shall govern the prosecution and progress of the work, with the following additions:

- 4.1.1 Prior to commencing construction, a meeting will be held with the Contractor and the Village. Any questions concerning procedures, general conditions, special provisions, plans or specific items related to the project shall be answered and clarified. No Pre-Construction meeting shall be scheduled until submittals, performance bonds, and certificates of insurance are delivered to, and approved by, the Village.

- 4.1.2 Weekly progress meetings may be required by the Village. If required, the Contractor shall have a capable person, such as a site superintendent or project manager, attend such meetings and be prepared to report on the prosecution of the Work according to the progress schedule.

5. MEASUREMENT AND PAYMENT

5.1 Section 109 of the SSRBC shall govern measurement and payment, with the following additions:

5.1.1 Modifies Article 109.07 - Partial payments will be made per Section 36 of Part II of this document (Billing and Payment Procedures.)

5.1.2 The Village will require that partial and final affidavits for all labor, materials and equipment used on the Project, be submitted with the partial and final payment requests. Such waivers shall indicate that charges for all labor, materials and equipment used on the project have been paid. Partial waivers from suppliers and subcontractors may be submitted after the first payment to the Contractor, and before the subsequent payment to that which they apply.

However, partial waivers from the Contractor must accompany the invoice of the payment to which it applies.

All final waivers, from all suppliers and subcontractors **MUST** accompany the Contractor's invoice upon submittal for final payment. A sworn statement by the Contractor shall accompany full waivers.

Such requirement for full waivers is solely for the benefit of the Village and shall not be construed to benefit any other person. Partial payment for work done shall in no way imply acceptance of the work to that date.

IV. SPECIAL PROVISIONS

The following Special Provisions shall modify, supercede, or supplement the Standard Specifications referred to in Section III - General Provisions.

Where any section, subsection, paragraph, or subparagraph of the Standard Specifications is *supplemented* by any of the following paragraphs, the provisions of such section, subsection, paragraph, or subparagraph shall remain in effect. The Special Provisions shall govern in addition to the particular Standard Specification so supplemented, and not in lieu thereof.

Where any section, subsection, paragraph, or subparagraph of the Standard Specifications is *amended, voided, or superceded* by any of the following paragraphs, any provision of such section, subsection, paragraph, or subparagraph standing unaffected, shall remain in effect. The Special Provisions shall govern in lieu of any particular provision of the Standard Specification so amended, voided, or superceded, and not in addition to the portion changed.

SP-1 GENERAL SCOPE OF WORK

This bid consists of the removal and replacement of approximately 20,000 square feet of PCC sidewalk and ramp installation in accordance with the Americans with Disabilities Act located within the limits of Village of Downers Grove. A list of locations will be provided prior to work commencing. This contract shall also include removal and replacement of approximately 1,000 square feet of Colored PCC sidewalk located within the Downers Grove downtown business district.

SP-2 GENERAL CONSTRUCTION REQUIREMENTS

The following general requirements are intended to govern the overall priority for the performance of the work described in this contract. As general requirements, they are not intended to dictate to the Contractor the precise method by which these tasks shall be performed.

All street openings made prior to November 15th shall be fully restored according to the applicable special provisions, and the street reopened to regular traffic upon the availability of hot-mix bituminous concrete.

No more than three hundred linear feet (300 LF) of pavement may be open-cut and closed to use by the motoring public. Access to **all** individual drives within the current work zone must be restored at the end of each workday.

The Contractor shall maintain traffic flow during the day in accordance with the applicable special provision. Adequate signing and flagging is of particular importance for safe travel of all residents.

SP-5 ACCESS AND WATER SHUT-OFF NOTIFICATION

If access to a driveway will be blocked, or water will be turned off, the Contractor shall give that resident or business proper written notification at least 24 hours in advance. The Contractor must provide them the opportunity to remove their cars from the drive or make other arrangements, and

prepare for any shutdown of the water system. Samples of written notices shall be submitted to the Engineer for approval.

In addition, the Contractor shall be responsible for notifying the resident or business verbally on the morning of any driveway closure, to ensure awareness of the lack of access.

Basis of Payment: This work shall be considered **INCIDENTAL** to the project.

SP-6 TREE PROTECTION

Municipal Codes regarding trees, including tree protection requirements for public parkway trees, are located in Chapter 24 of the Downers Grove Municipal Code. Specifically, Municipal Codes 24-7 and 24-8 detail the public parkway tree protection sizes and fines for violations. The Village Forester shall approve all tree protection measures and any deviations. All tree protection measures and any deviations shall be noted in the contract specifications and on approved project plan sheets and permits using the guidelines listed below.

Tree protection shall include avoiding damage to the above ground tree branches and trunk, and the below ground root system and surrounding soil. Tree crowns and trunks shall not suffer any branch or bark loss.

Roots shall be protected from compaction, storage of materials, severing, regrading of the parkway or excavation unless specifically noted on the project plan sheets.

The Critical Root Zone, or CRZ, is the area immediately surrounding a tree that must be protected from damage. In a municipal parkway setting with utilities and paved or concrete surfaces, the size of the CRZ has been adjusted to form a rectangle around the parkway tree trunk with minimum dimensions listed in the following table. The depth of the CRZ extends to 4 feet below the natural ground surface level.

<u>Parkway Tree diameter at 4.5'</u>	<u>Width street to property (min. curb to sidewalk)</u>	<u>Length along street street(minimum)</u>	<u>Depth</u>
0 – 12.0 inches	10.0 feet	10 feet	4 feet
12.1 – 24.0 inches	10.0 feet	20 feet	4 feet
24.1 or more inches	10.0 feet	30 feet	4 feet

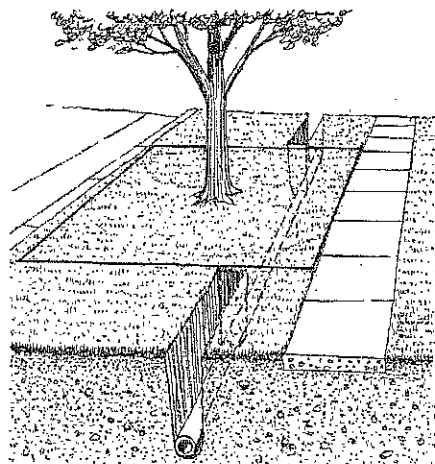

For projects that involve excavations of less than one (1) foot in depth in the parkway or street and are replacing structures in the same location, fencing of the public parkway trees shall not be required.

Example projects include, but are not limited to, street pavement resurfacing, curb removal/replacement, driveway removal/replacement, or sidewalk removal/repairs or new sidewalk installations. Contractors shall be mindful of the CRZ dimensions and potential for fines if any parkway trees suffer any unauthorized damage as determined by the Village Forester.

For projects that involve excavations of more than one (1) foot in depth in the parkway or street or both, fencing of the public parkway trees shall be required. Example projects include, but are not limited to, watermain replacements with new roundway keystops and domestic service box installations, sanitary line replacements and new service connections, new or replacement natural gas services, new or replacement phone or fiber optic lines, or new or replacement storm sewers, or projects that widen roads which in turn decreases the parkway soil volume around public parkway trees.

Projects that require fencing (listed above) shall fence the public parkway trees with six (6) foot high chain link construction fence secured to metal posts driven in the ground which are spaced no further than ten (10) feet apart. The dimensions of the fence shall depend on the tree diameter size and shall follow the table listed for the CRZ above, or as large as practical dependent on driveways and other field conditions. The fenced rectangle shall have three (3) sides with the opening facing the adjacent residences for easy access for mowing or tree care. Under no circumstances shall any items be stored within the fence. All fencing shall be maintained daily in an upright good condition. The size and location of all fencing shall be shown on the project plan sheets.

To avoid damage to the CRZ, utilities must be augered underneath the public parkway trees. Excavation pits for augering equipment are to be outside the fenced area and are to be shown on the project plan sheets. Excavation pits for roundway keystops and domestic service boxes are to be as small as practical with excavation occurring in a direction away from the adjacent public parkway tree.

In cases when severing of roots within a portion of the CRZ may be unavoidable (ex. sidewalk installation, curb replacement, water or sanitary service replacement), subject to the approval of the Village Forester, sharp clean cuts shall be made on root ends to promote wound closure and root regeneration. Root pruning and excavation activities shall occur such that the smallest volume of soil and roots is disturbed, and the locations shall be shown on the project plan sheets.

In addition to fines and citations that may be assessed for violations of any Chapter 24 of the Municipal Code (such as not maintaining fencing around the CRZ or unauthorized removal of protected trees), the contractor may be subject to the following provisions:

- Issuance of an invoice for the value or partial value of the tree lost due to damage to either the above ground or below ground portions of the parkway tree, or unauthorized tree removal.

- Costs of repairs, such as pruning or cabling, or costs for removal of the damaged parkway tree along with the stump if the tree cannot remain in the right-of-way.
- Fines of \$500 for the 1st offense; \$1,000 for the 2nd offense; \$2,500 for the 3rd and subsequent offenses.
- Each day during which a violation continues shall be construed as a separate and distinct offense.

The value or partial value of the tree lost shall be determined by the Village Forester using the most current edition of the Guide for Plant Appraisal (prepared by the Council of Tree & Landscape Appraisers and the International Society of Arboriculture) and the most current edition of the Species Ratings & Appraisal Factors for Illinois (prepared by the Illinois Arborist Association). The total cost determined for the damage shall be deducted from the payments made to the Contractor for the project.

Should the Village hire another Contractor or tree service to complete pruning work, these costs shall also be deducted from the payments made to the Contractor.

Basis of Payment: This work shall be considered **INCIDENTAL** to the project.

Tree removal as defined by the standard specifications, which will be paid for separately.

SP-7 EROSION AND SEDIMENTATION CONTROL

Description: Throughout each and every phase of the project, all downstream ditches and storm sewers shall be protected from the run-off of roadway surfaces, excavations, and other construction activities generating the movement of dirt, mud, dust and debris. This work shall consist of constructing temporary erosion and sedimentation control systems as shown on the plans or as directed by the Engineer. The work shall be placed by methods and with materials in accordance with Sections 280, 1080 and 1081 of the SSRBC, except as amended herein.

All downstream ditches shall be protected from erosion and sedimentation by the installation of straw bale and/or silt fence ditch checks. Piles of excavated material and/or trench backfill material, allowed to be in place in excess of three days, shall be protected against erosion and sedimentation runoff by use of straw bales. Storm sewer inlet structures or manholes shall be protected by temporary placement of geotextile fabric, straw bales, or solid lids, as authorized in the field by the Engineer.

Erosion and sedimentation control measures as indicated in the Erosion Control Plan, or as directed by the Engineer shall be installed on the project site prior to beginning any construction activities which will potentially create conditions subject to erosion. Erosion control devices shall be in place and approved by the Engineer as to proper placement and installation prior to beginning other work. Erosion control protection for Contractor equipment storage sites, plant sites, and other sites shall be installed by the Contractor and approved by the Engineer prior to beginning construction activities at each site.

Silt Fence Placement, maintenance, and removal of silt fence at areas designated by the Engineer. The work shall be placed by methods and materials in accordance with Sections 280 and 1080 of the SSRBC, except as amended herein.

Basis of Payment: This work shall be considered **INCIDENTAL** to the project.

SP-8 TRAFFIC CONTROL, MAINTENANCE OF TRAFFIC, DETOURS (ITEM# 70103900)

Description: This item shall include the furnishing, installing, maintaining, relocating and removing of all traffic control devices and personnel used for the purpose of regulating, warning, or directing traffic during the construction of this project.

All traffic control devices used on this project shall conform to the Standard Specifications for Traffic Control Devices and the Illinois Manual on Uniform Traffic Control Devices.

No waiving of these requirements will be allowed without prior written approval of the Engineer.

The Contractor shall protect all workers engaged in the project, and shall provide for safe and convenient public travel by providing adequate traffic control under all circumstances.

Such circumstances may include, but not be limited to work performed along the route under construction, road closures for construction operations of any type, or when any section of the road is opened to traffic prior to completion of all work. The Contractor shall ensure that work zone in question is properly signed, barricaded and otherwise marked.

The Contractor will be responsible for the proper location, installation, and arrangement of all traffic control devices during the period of construction. All open excavations shall be protected by Type I barricades equipped with working bi-directional flashing lights at each end of the excavation, as well as at 50-foot intervals between ends for excavations greater than 50 feet in length and weighted down by **one sandbag per each barricade**. All street closures shall be protected by Type III barricades equipped with working bi-directional flashing lights and weighted down by **eight sandbags per each barricade**.

The Contractor shall plan his work so that there will be no open excavations during non-working hours and that all barricades not necessary have been removed from the pavement during non-working hours.

In the event that one direction of vehicular travel must be closed, the Contractor has the option of setting up a detour route or using flaggers (minimum of two) to direct traffic around the work area. The Engineer shall approve proper signing and barricading of the detour route and lane closures, and shall issue written authorization prior to closure.

In the event that both directions of vehicular travel must be closed, the Contractor shall set up a detour route to direct traffic around the work area. The Engineer shall approve proper signing and barricading of the detour route and shall issue written authorization prior to closure.

The Contractor shall maintain his operations in a manner such that traffic flow shall not be substantially impeded during the construction of the proposed improvements.

Where traffic must cross open trenches during a given work day, the Contractor shall provide steel plates at street intersections and driveways. Prior to the end of a given work day, the pavement surface shall be temporarily restored.

No open excavation may be left overnight or on the weekend without the express written permission of the Engineer.

No street closure shall be permitted without the express written permission of the Engineer. No street closure may exceed 800 linear feet, nor be in effect from Friday night at 4:30PM to Monday morning at 9:00AM. Where it is necessary to establish a temporary detour, all the requirements of the Standard Specifications and MUTCD shall be met.

As the condition and location of the work changes, the Contractor shall maintain all traffic control devices and personnel engaged in traffic control, in a manner that will accommodate the changing particulars of the work at any given time.

Advance warnings, detour and directional information and other controls or directions necessary for safe passage of traffic around the work site shall be reviewed and changed, if necessary, to meet the needs of the situation. Signage erected, but not necessary or proper for the situation ahead shall be covered or taken down. Barricading and signage shall be monitored by the Contractor on a daily basis to ensure that it meets the requirements for work zone safety for the conditions of the particular work being performed.

The Contractor shall provide a name and phone number of a responsible party capable of providing emergency service, 24 hours per day, for the duration of the Project.

Basis of Payment: This work shall be paid for at the contract LUMP SUM price for:

TRAFFIC CONTROL, MAINTENANCE OF TRAFFIC, DETOURS,

which price shall be payment in full for the installation and maintenance of proper traffic control to protect the work and public for the duration of the Project.

SP-12 SCHEDULING OF CONSTRUCTION

Description: At all locations, restoration of the driveway and parkway areas shall commence no later than 3 weeks after the concrete is placed. A construction schedule shall be submitted by the Contractor to the Engineer at the scheduled pre-construction meeting. **The Contractor shall only be allowed to conduct his operations in the Downtown Business District (DBD) between the hours of 9:00 a.m. & 3:00 p.m. Monday through Friday. Also, any and all construction operations in the DBD shall be completed prior to the list of events noted in Appendix A of these specifications.**

SP-13 PORTLAND CEMENT CONCRETE SIDEWALK, 5 INCH, SPECIAL (ITEM # 42400430)

Description: This work shall consist of the removal and replacement of existing P.C.C. sidewalk and the installation of new P.C.C. sidewalk as indicated by location or shown on the plans. All P.C.C. sidewalks shall be removed and replaced by methods and with materials in accordance with Articles 424 and 1020.04 of the SSRBC, except as amended herein.

Removal of existing sidewalk shall include saw cutting, removal and disposal of existing concrete, bricks, bituminous paved sidewalks and/or bituminous overlayment of existing sidewalks, and tree roots.

Placement of sidewalk shall include the following:

- a) Removal of existing sidewalk;
- b) Excavation of additional four inches (4") of earth and placement of four inches (4") of Type B, CA-6 compacted aggregate base course at locations where aggregate base is not existent or where determined by the Engineer;
- c) The set up of form work such that the maximum longitudinal slope of the finished walk does not exceed 8.33 percent (1 inch in 12 inches), and the lateral slope is not more than 1/4 inch per 12 inches.
- d) The placement of five inch (5") thick, Class SI Portland Cement Concrete, 6.1 cwt/cy mix, with 6% air entrainment, 3"-5" slump, and six inch (6") thickness through or in driveways or where subject to vehicular traffic, to the width specified on the plans or as directed by the Engineer;
- e) The tooling of contraction joints, 3/4-inch radius and 1 inch deep, 5 feet on center;
- f) The placement of 3/4 inch thick premoulded expansion joints at 100 foot intervals on center, or abutting existing concrete sidewalk, or at the end of a pour;
- g) The adjustment of all utility structures encountered to proper grade;
- h) The replacement of all traffic control devices or parking meters removed;
- i) The proper curing of all concrete work utilizing methods and materials outlined in Articles 424 and 1022.01 of the SSRBC, (Type III membrane curing compound white pigmented);
- j) The complete restoration of abutting Hot-Mix Asphalt (HMA) driveways damaged as a result of installation, or where the sidewalk surface is more than 1/2 inch higher or lower than the original grade of the HMA drive. Restoration shall consist of a minimum of one foot either side of the sidewalk; with a minimum of three inch (3") thick HMA Surface Mixture C, N50 (IL 9.5) surface course; and restoration of gravel drives with similar HMA restoration.
- k) The complete restoration of damaged parkways to the satisfaction of the Engineer.

The placement of concrete shall not be allowed prior to the Engineer inspecting the aggregate base course. PCC sidewalk installed without prior approval of the aggregate base course will not be accepted for payment.

Basis for Payment: This work shall be paid for at the contract unit price per **SQUARE FOOT** for:

PORTLAND CEMENT CONCRETE SIDEWALK, 5 INCH SPECIAL,

which price shall be payment in full for the work as specified herein.

SP-14 PORTLAND CEMENT CONCRETE SIDEWALK 5 INCH (COLORED)

Description: This work shall include all work included in SP-13 in addition to the following. Work will consist of removal and replacement of existing continuous sidewalk sections located in the Downtown Business District with a "California Finish" finish. Concrete sidewalk shall be installed with the addition of a concrete colorant. The colorant shall be "Harvest Wheat" (Product #U16) supplied by Butterfield Color (1-800-282-3388). Concrete colorant shall be approved by the Engineer before use. This work shall also include framing for tree grate curb by constructing a thickened reinforced sidewalk edge around tree grates. See detail drawings in specifications.

Basis for Payment: This work shall be paid for at the contract unit price per **SQUARE FOOT** for:

PORTLAND CEMENT CONCRETE SIDEWALK, 5 INCH (COLORED),

which price shall be payment in full for the work as specified herein.

SP-15 DETECTABLE WARNING (ITEM# 42400800)

Description: This work shall consist of the installation of new detectable warning material as shown in the plans. All detectable warnings shall be placed by methods and with materials in accordance with Article 424 and 424.09 of the SSRBC except as amended herein.

Each Detectable Warning shall consist of 2' x 4' brick red panels inserted into wet concrete. Detectable Warning shall be "Access-Tile" Cast-In-Place Replaceable or equivalent.

Basis for Payment: This work shall be paid for at the contract unit price per **SQUARE FOOT** for:

DETECTABLE WARNING,

which price shall include all material, labor, and equipment necessary to complete this item.

SP-16 COMBINATION CONCRETE CURB AND GUTTER REMOVAL AND REPLACEMENT (ITEM # 44001700)

Description: This work shall consist of the removal and replacement of existing PCC curb and gutter, or the placement of PCC curb and gutter where none exist, of the type, size and location as shown in the contract documents. All PCC curb and gutter shall be removed and replaced by methods and materials as specified in Articles 606 and 1020 of the SSRBC, except as amended herein.

Removal of curb and gutter shall include all necessary saw cutting, excavation, disposal of excess materials, removal of any overlayment of pavement, monolithic underlying base, or brick pavement.

All adjoining driveway pavements and/or sidewalk surfaces and base shall be repaired by methods and approved materials by the Engineer, and shall be considered incidental to combination curb and gutter removal and replacement, unless otherwise noted on the plans.

This work may also include the removal and replacement of existing sections of curb in Village owned parking lots, as well as depressed curb and gutter for handicap ramps as indicated for new sidewalk construction, and where existing sidewalk is removed and replaced at crosswalks.

Placement of PCC combination curb and gutter shall include the following:

- a) Class SI Portland cement concrete, 6.1 cwt/cy mix with 6% air entrainment and three inch (3") slump;
- b) Saw cutting of concrete with two inch (2") deep joints at not more than 15-foot intervals within 24 hours after concrete is placed;
- c) Placement of two (2) smooth, epoxy coated dowel bars into the gutter flag portion of existing concrete curb, and at expansion joints in accordance with the detail shown on the contract documents;
- d) Placement of 3/4 inch pre-moulded expansion joint filler perpendicular to the centerline of the roadway:
 - 1) For the full depth of the curb and gutter;
 - 2) Where abutting existing concrete curb and gutter;
 - 3) At five feet (5') on either side of utility structures;
 - 4) At construction joints at ends of pours;
 - 5) At not more than ninety foot (90') intervals.
- e) Proper curing of all concrete work utilizing the methods and materials outlined in Articles 424 and 1022.01 of the SSRBC (Type III membrane curing compound white pigmented);
- f) Backfilling of all curb work with materials approved by the Engineer;
- g) Excavation for, and the installation of, compacted topsoil and sod to a minimum width of eighteen inches (18") from the back of curb, or for width equal to area disturbed by the installation of curb if greater, in accordance with the specification PARKWAY RESTORATION;
- h) Complete restoration of disturbed parkways with topsoil and seed along the back of curb.

All curb and gutter shall be monolithic Type B-6.12 MODIFIED unless otherwise noted in the contract documents.

Basis for Payment: This work shall be paid for at the contract unit price per **LINEAR FOOT** for:

**COMBINATION CONCRETE CURB AND GUTTER
REMOVAL AND REPLACEMENT,**

which price shall be payment in full for the work as specified herein.

SP-17 PIPE DRAINS, 4" (ITEM # 60100905)

Description: This work shall consist of the installation of 4" diameter Schedule 40 PVC pipe to accommodate the placement of new PCC sidewalk over or near existing drain pipe locations flowing nominally perpendicular to the new sidewalk into roadside ditches. Placement of pipe shall include a minimum of two inch (2") stone bedding backfilled such that the pipe is completely surrounded with a minimum of two inches (2") of stone. Mission couplings shall be included when extending or repairing existing drain files. All PVC pipe shall meet the material requirements of Article 1040.03, in accordance with the requirements of the SSRBC. Depending upon application, and as directed by the Engineer, piping may or may not be perforated and shall have a smooth interior lining.

Basis for Payment: This work shall be paid for at the contract unit price per **LINEAR FOOT** for:

PIPE DRAINS, 4",

which price shall be payment in full for all excavation, placement of bedding and backfill material, compacting and adjusting grade surrounding pipe culvert, preparation for accepting placement of new sidewalk, and parkway restoration as specified herein.

SP-18 MANHOLES TO BE ADJUSTED (ITEM # 60255500)

Description: This work shall consist of the adjustment of water valve vault, drainage, traffic signal, street lighting, and sanitary structure frames and grates or covers. All utility structure frames and grates shall be adjusted by the Contractor where necessary to meet the proposed elevation of the new sidewalk surface, or where removal and replacement of existing sidewalk is being performed in order to correct the elevation of the sidewalk relative to the existing utility structure or the existing nominal elevation of the walk on either side of the sidewalk portion to be replaced.

The adjustments to the frames and grates shall be performed at the direction of the Engineer, or representatives of the appropriate utility. The maximum vertical adjustment shall not exceed one foot (1'). Adjustments shall only be made with concrete adjusting rings of a thickness appropriate to the particular adjustment, and shall be secured by mastic joint sealer. Adjustments shall not be made with brick, mortar, wood, or other material.

Basis of Payment: This work shall be paid for at the contract unit price per **EACH** for:

MANHOLES TO BE ADJUSTED,

which price shall be payment in full for the removal and/or replacement of the existing frame and grate, pre-cast concrete adjusting rings, and compacting and adjusting the grade immediately around the structure.

SP-19 PCC DRIVEWAY REMOVAL AND REPLACEMENT

Description: This work shall consist of the replacement of all PCC driveways that are removed during the course of construction. Driveways shall be replaced to the limits as determined by the

maximum width of trench permitted by the Water and Sewer Specifications.

Removal beyond the limitations noted above shall be done only after the Contractor has received written authorization from the Engineer to perform the work.

Replacement of the driveways shall consist of the following:

- a) A transverse saw cut made one foot (1') beyond the edge of the trench, or as directed by the Engineer;
- b) Shaping and preparing subgrade and slopes adjacent to driveways at all locations accordingly. The maximum grade for the side slopes shall not exceed 33 percent.
- c) Base course consisting of six inches (6") of Type B, CA-6 compacted aggregate base course, measured after placement and compaction.
- d) Surface course consisting of six inches (6") of Class PV PCC.

Driveways shall be placed by methods and materials outlined in Articles 423 and 1020.04 of the SSRBC.

All concrete work shall be properly cured utilizing the materials and methods outlined in Section 1022 of the SSRBC except that Type III membrane white pigmented curing compound shall be used.

Basis of Payment: This work shall be paid for at the contract unit price per SQUARE YARD for:

PCC DRIVEWAY REMOVAL AND REPLACEMENT,

which price shall be payment in full for the work as specified herein.

**SP-20 HOT-MIX ASPHALT DRIVEWAY PAVEMENT, 3" (SPECIAL) (ITEM # Z0004510),
HOT-MIX ASPHALT SIDEWALK TRANSITION – 5"**

Description: This work shall consist of the removal and replacement of Hot-Mix Asphalt (HMA) driveways exceeding one foot (1') on either side of the installed sidewalk and the installation of a minimum two foot (2') wide protective asphalt edge on either side of the sidewalk where installation is made through a gravel drive. **Removal beyond the limits of incidental asphalt removal and replacement shall be done by the Contractor only at the direction of the Engineer.** Said removal shall only be performed in order to adjust the existing driveway so it may meet the grade of the new sidewalk.

Hot-Mix Asphalt Sidewalk Transition – 5" shall consist of installation of an HMA Sidewalk transition between the edge of pavement and concrete sidewalk. This work will be required for all sidewalk ramps adjacent to streets that do not have an existing curb and gutter.

The HMA shall be placed on a minimum of six inches (6") of Type B, CA-6 compacted aggregate base course, consisting of a minimum of two 1-½ inch lifts of compacted HMA Surface Mix C, N50 (IL 9.5). HMA shall be placed by methods and materials outlined in Articles 406 and 1009 of the SSRBC. This work shall be completed by an IDOT certified asphalt contractor, in accordance

to IDOT and Village of Downers Grove public right-of-way specifications. All areas of work shall be properly excavated, prepared, and compacted. All edges that meet graded parkway areas shall be neatly tamped.

Two separate 1-½ inch compacted lifts of HMA Surface Mix shall be applied.

Construction of the sidewalk transition shall include the following:

- a) Excavation as necessary for the full width of the concrete sidewalk;
- b) Placement and compaction of four inches (4") of Type B, CA-6 aggregate base
- c) Placement and compaction of three inches (3") of HMA Surface, Mix C, N50 (IL 9.5) per the applicable portions of Sec. 442 of the Standard Specifications.

Basis of Payment: This work shall be paid for at the contract unit price per **SQUARE YARD** for:

**HOT-MIX ASPHALT DRIVEWAY PAVEMENT, 3" (SPECIAL) or
HOT-MIX ASPHALT SIDEWALK TRANSITION – 5",**

which price shall be payment in full for the preparation of the area to be paved, proper disposal of excavated and surplus materials, and placement of bituminous concrete materials.

SP-21 TREE ROOT PRUNING

Description: All trees, public or private, affected by new sidewalk installation within the root protection zone, shall be root pruned prior to any excavation occurring.

Tree root pruning shall be performed in accordance with the Tree Protection Zone detail of the contract documents, and shall be done only to the depth of the excavation necessary for installing the new sidewalk. Root pruning shall start and proceed uninterrupted for the length of travel through the root protection zone. Root pruning shall be made no more than 10 inches from the tree-side edge of the proposed sidewalk.

Approval by the Village Forester of the equipment to be used for tree root pruning, as well as the proposed path of the root pruning work, is required prior to the work being performed. The Engineer or his representative shall permit no excavation until written approval is obtained by the Contractor from the Village Forester. No materials or equipment may be stored or kept in the Tree Protection Zone. Tree damage, as determined by the Village Forester, shall be assessed to the Contractor using the most recent edition of the Guide for Plant Appraisal, published by the International Society of Arboriculture.

Basis of Payment: This work shall be paid for at the contract unit price per **EACH** for:

TREE ROOT PRUNING,

which price shall be payment in full for the work as specified herein and as measured in place.

SP-22 DOMESTIC WATER SERVICE BOXES TO BE ADJUSTED (ITEM # 56500600)

Description: Where encountered, all water service access facilities (buffalo boxes, etc.) shall be

adjusted to grade. If needed, the contractor shall be responsible for installing sleeve extensions that match the existing diameter and threading. The Engineer or representative thereof shall approve prior to work.

Basis of Payment: This item shall be paid for at the contract unit price per **EACH** for:

DOMESTIC WATER SERVICE BOXES TO BE ADJUSTED,

which price shall be payment in full for the work as specified herein.

SP-23 DOMESTIC WATER SERVICE BOXES TO BE REPLACED (ITEM # 56500800)

Description: This work shall consist of replacement of domestic water service box using pre-cast concrete support blocks and a buffalo style Tyler 95- E service box. Only cast iron buffalo style boxes and lids are allowed. The cover of the buffalo box shall have the word "WATER" cast thereon.

Basis of Payment: This item shall be paid for at the contract unit price per **EACH** for:

DOMESTIC WATER SERVICE BOXES TO BE REPLACED,

which price shall be payment in full for the work as specified herein.

SP-24 AGGREGATE BASE COURSE, TYPE B, 4"

Description: Aggregate Base Course, Type B, 4" shall meet the requirements of Section 351 and Art. 1004.04 of the SSRBC "CA-6" gradation, except that GR-7 gravel shall not be allowed. Aggregate Base Course, Type B, 4" shall be used when under paved areas or structures.

Aggregate Base Course shall be compacted by vibrating plate or other mechanical compacting device in a manner consistent with the Standard Specifications, to ensure that no future settlement occurs.

Existing aggregate base course can be reused if approved by the Engineer. Compacting of reused aggregate base course shall be required.

Basis of Payment: This item shall not be paid for separately but shall be **INCIDENTAL** to:

**PORTLAND CEMENT CONCRETE SIDEWALK, 5 INCH, SPECIAL
or
PORTLAND CEMENT CONCRETE SIDEWALK, 5 INCH, (COLORED).**

SP-25 EXCAVATION

Description: Costs for all items requiring excavation (i.e. Portland Cement Concrete Sidewalk, Combination Curb and Gutter Removal and Replacement, and Pipe Drains) shall be **INCIDENTAL** towards implementation of this project.

Basis of Payment: No additional compensation will be allowed the Contractor.

SP-26 SAW CUTTING

Description: This work shall consist of saw cutting existing sidewalk along the limits of removal as indicated by the Engineer. Saw cutting shall be full depth for bituminous pavement and 1-1/2 inch depth for concrete through drive approaches for removal of driveway necessary for sidewalk installation for the purpose of delineating sidewalk edges and contraction joints where none currently exist.

Basis of Payment: Saw cutting shall not be paid for separately but shall be **INCIDENTAL** to the contract.

SP-27 SIGN RELOCATE

Description: The Contractor shall remove and relocate all signs located in or near the construction zone as directed by the Engineer. The Contractor shall be responsible for replacing, at his expense, any signs damaged during the course of construction and the operation of removing and relocating any signs.

Basis of Payment: The removal and relocation of all existing signs in or near the construction zone shall not be paid for separately but shall be **INCIDENTAL** to the contract.

SP-28 CLEARING, TREE AND HEDGE REMOVAL

Description: This work shall consist of the removal and disposal of all obstructions encountered during the construction of this improvement. Clearing shall consist of the removal and disposal of all obstructions such as fences, walls, foundations, buildings, accumulations of rubbish of whatever nature and all logs, shrubs, brush, grass, weeds, other vegetation and stumps of less diameter than 6 inches.

Tree removal shall consist of the cutting, grubbing, removal and disposal of all trees and stumps as hereinafter defined. Hedge removal shall consist of the pulling or grubbing, removal and disposal of all hedge trees or bushes, as hereinafter defined.

A tree shall be defined as a woody, perennial plant having a single main stem or trunk, the diameter of which is 6 inches or more at a point 4 1/2 feet (diameter breast height) above the highest ground level at the tree. Trees with a diameter less than 6 inches will be considered as shrubs. A tree stump with a diameter at cut-off of 6 inches or more will be considered a tree for purposes of measurement and removal. A hedge shall be defined as trees or bushes planted for fence or windbreak purposes in rows containing 20 or more trees or bushes per 100 linear feet.

Rows containing less than 20 trees or bushes per 100 linear feet, and scattered hedge trees or bushes will not be considered a hedge but as trees or shrubs, in accordance with the diameter measurements herein specified.

All trees, stumps, shrubs and bushes designated for removal shall be removed to a depth of not less than 12 inches below the elevation of the sub-grade, the finished earth surface or the ground line.

All trees and shrubs designated to be saved shall be protected during clearing and subsequent construction operations.

Overhanging limbs shall be trimmed or cut off to provide a minimum vertical clearance of 7 feet from the finished surface. This shall be considered as clearing. In the event that the Contractor damages any tree or shrub designated to be saved, such plants shall immediately be repaired or replaced as directed by the Engineer in accordance with standard horticultural practice for such work, at the Contractor's expense. Hedge shall not be cut off at the ground level, but shall be pulled or grubbed in such a manner as to ensure complete removal. Scattered hedge trees or shrubs not classified as hedge shall be removed as specified for hedge.

Basis of Payment: Clearing, tree & hedge removal shall not be paid for, but shall be considered **INCIDENTAL** to the contract.

Downtown Business District Colored Concrete Removal & Replacement Locations

STREET NAME	WALK LENGTH (FT)	WALK WIDTH (FT)	WALK R&R AREA (SF)
MAIN ST & MAPLE AVE (NW)	6	6	36
5101 MAIN ST	12	4	48
CURTISS ST & MOCHEL DR (NW)	4	4.5	18
	4	4.5	18
933 CURTISS ST	5	4.5	23
	10	4	40
925 CURTISS ST	4	4.5	18
923 CURTISS ST	13.5	4	54
	4.5	4.5	20
1037 CURTISS ST	4.5	4.5	20
	4.5	4.5	20
	4.5	4.5	20
	4.5	4.5	20
5140 MAIN ST	6	3.5	21
	6	5	30
5137 MAIN ST	8	3.5	28
920 CURTISS ST	10	5	50
1030 WARREN AVE	6	5	30
MAIN ST & WARREN AVE (SW)	6	4	24
4946 MAIN ST	6	5	30
	6	5	30
	6	5	30
4930 MAIN ST	5	4.5	23
4900 MAIN ST	5	5	25
FOREST AVE & WARREN AVE (SE)	10	8	80
HIGHLAND AVE & WARREN AVE (NW)	10	8	80
965 ROGERS ST	6	4	24
994 WARREN AVE	6	6	36

Preliminary First Priority Sidewalk Removal & Replacement Locations

First Priority Address	# of SQ's
111 39th Street	2
240 4th Street	14
324 4th Street	2
448 59th Street	3
59th Street & Eldon Place (NE)	1
432 59th Street	3
728 59th Street	2
520 60th Street	8
601 61st St	2
649 61st St	2
1430 Acorn Avenue	4
6761 Barrett St	4
7301 Binder Road	2
825 Birch Avenue	2
826 Birch Avenue	1
6649 Blackstone Drive	3
1430 Branding Avenue	4
915 Burlington Avenue	8
5520 Carpenter Avenue	22
1701 Concord Dr	1
839 Curtiss Street	4
5730 Dearborn Pkwy	1
5809 Dearborn Pkwy	1
5818 Dearborn Pkwy	1
5617 Dunham Road	2
5627 Dunham Road	3
4724 Elm Street	2
4510 Fairview Avenue	5
4528 Fairview Avenue	2
5322 Fairview Avenue	2
5313 Fairview Avenue	1
4718 Fairview Avenue	3
5209 Florence Avenue	1
3910 Glendenning Rd	1
6135 Grand Avenue	1
2420 Haddow Avenue	1
3411 Hickory Court	3
1390 Hickory Court	2
Public right-of-way Hickory Court (vacant lot)	1
3421 Hickory Court	1
1391 Hickory Court	3
3827 Highland Avenue	10
4936 Highland Avenue	1
4940 Highland Avenue	1

First Priority Address (cont'd.)	# of SQ's
5930 Hillcrest Court	2
6003 Hillcrest Court	1
6006 Hillcrest Court	1
6000 Hillcrest Court	2
6900 Hillcrest Road	3
6910 Hillcrest Road	3
7205 Kidwell Road	4
7116 Kidwell Road	4
7200 Kidwell Road	4
7209 Kidwell Road	3
7213 Kidwell Road	2
5933 Lyman Court	1
5840 Lyman Avenue	1
5429 Lyman Avenue	1
7216 Main Street	2
356 Maple Avenue	16
706 Maple Avenue	9
6731 Meadowcrest Drive	1
4704 Middaugh Avenue	6
2161 Midhurst Road	6
1001 Ogden Avenue	7
311 Otis Avenue	3
over St. Joe creek at Grand Avenue	7
6036 Ridge Court	4
6033 Ridgewood Circle	2
6030 Ridgewood Circle	4
6000 Ridgewood Circle	3
5924 Ridgewood Circle	1
1521 Ridgewood Circle	1
1506 Ridgewood Circle	1
1500 Ridgewood Circle	1
1433 Ridgewood Circle	1
1427 Ridgewood Circle	2
1421 Ridgewood Circle	1
1412 Ridgewood Circle	1
1400 Ridgewood Circle	2
1401 Ridgewood Circle	1
4925 Saratoga Avenue	5
6800 Saratoga Avenue	4
6810 Saratoga Avenue	4
6941 Springside Avenue	2
4501 Statton Street	2
1441 Terrace Drive	5
802 Warren Avenue	2
1208 Warren Avenue (vacant lot E. of 1212 Warren)	2

First Priority Address (cont'd.)	# of SQ's
6101 Washington Street	1
7208 Webster Street	3
1481 Wood Avenue	1
4605 Woodward Avenue	6

Preliminary Second Priority Address	# of SQ's
324 56th Street	1
500 59th Street	2
819 59th Street	6
59th Street & Fairmount Avenue (NE)	3
5115 Blodgett Avenue	3
5222 Blodgett Avenue	2
5336 Blodgett Avenue	5
5417 Blodgett Avenue	1
Blodgett Avenue & Hill Street (NE)	3
4011 Bryan Place	3
421 Burlington Avenue	4
626 Chicago Avenue	2
844 Chicago Avenue	4
904 Chicago Avenue	2
2400 Curtiss Street	1
Dearborn Parkway & 59th Street (NE)	1
Dearborn Parkway & 59th Street (NW)	2
4433 Douglas Road	8
4622 Douglas Road	3
4942 Douglas Road	6
516 Eldon Place	2
625 Fairmount Avenue	3
5305 Fairmount Avenue	3
5841 Fairmount Avenue	2
4600 Forest Avenue	5
536 Hill Street	5
5240 Grand Avenue	2
4343 Highland Avenue	11
4345 Highland Avenue	1
Hill Street & Blodgett Street (NE)	4
Hill Street & Fairview Avenue (NW)	5
Hill Street & Fairview Avenue (SW)	3
5413 Lyman Avenue	2
5833 Lyman Avenue	2
4501 Main Street	1
4547 Oakwood Avenue	2
4628 Oakwood Avenue	1
4632 Oakwood Avenue	2
406 Otis Street	1
414 Otis Street	3
422 Otis Street	1
4340 Prince Street	2
4541 Prince Street	2

Second Priority Address (cont'd.)	# of SQ's
4644 Prince Street	3
Randall Street & Park Avenue (SE)	1
Randall Street & Park Avenue (SW)	1
4803 Saratoga Avenue	2
6800 Saratoga Avenue	3
4343 Sherman Street	11
4516 Sherwood Avenue	2
Summit Street & Blodgett Avenue (NW)	1
Summit Street & Blodgett Avenue (SW)	1
Summit Street & Park Avenue (NW)	3
1421 Terrace Drive	3
1446 Terrace Drive	5
3800 Venard Road	2
5006 Washington Street	2
5305 Washington Street	2
6801 Wolf Place	4
6800 Wolf Place	5
6813 Wolf Place	6
6807 Wolf Place	4

Preliminary Third Priority Address	# of SQ's
Highland School	3
Highland School	4
Highland School	6
Fairview across street from vacant lot.	6
3800 Belle Aire Drive	2
3810 Belle Aire Drive	2
3841 Belle Aire Drive	3
3821 Belle Aire Drive	2
814 Birch Avenue	1
825 Birch Avenue	1
827 Birch Avenue	1
835 Birch Avenue	2
839 Birch Avenue	4
5619 Dunham Road	1
5617 Dunham Road	4
5613 Dunham Road	1
5601 Dunham Road	3
5539 Dunham Road	1
5625 Dunham Road	1
6901 Dunham Road	1
6905 Dunham Road	1
6661 Dunham Road	1
6301 Dunham Road	1
6301 Dunham Road	1

Third Priority Address (cont'd.)	# of SQ's
516 Eldon Place	1
5118 Elmwood Avenue	3
5126 Elmwood Avenue	3
5130 Elmwood Avenue	3
5138 Elmwood Avenue	1
4605 Forest Avenue	1
4624 Forest Avenue	3
4640 Forest Avenue	2
Whittier School	2
Whittier School	14
Whittier School	15
5126 Walnut Avenue	3
5230 Walnut Avenue	1
5411 Walnut Avenue	5
? Walnut Avenue	2
5225 Walnut Avenue	2
St Mary Church	3
St Mary School	13
St Mary School Parking Lot	10
St. Luke Pres. Church	6
Randall Street & Summit Street (SW)	1
307 Otis Avenue	1
YMCA on 59th Street	4
north side of Lester School	9
Lester School	1
Lester School	5
6701 Main Street	17
1864 63rd Street	11
520 60th St	8
600 60th Street	1
5934 60th Street	5
601 61st Street	2
649 61st Street	2
1500 71st Street	1
618 72nd Street	2
612 72nd Street	2
610 72nd Street	1
226 7th Street	2
237 7th Street	1
418 Austin Street	2
616 Austin Street	1
405 Austin Street	1
504 Douglas Road	5

5809 Dearborn Parkway	2
604 Dearborn Parkway	3
5736 Dearborn Parkway	1
5148 Dearborn Parkway	1
5818 Dearborn Parkway	2
5705 Dearborn Parkway	1

V. BID and CONTRACT FORM (Village)

*****THIS BID WHEN ACCEPTED AND SIGNED BY AN AUTHORIZED SIGNATORY OF THE VILLAGE OF DOWNERS GROVE SHALL BECOME A CONTRACT BINDING UPON BOTH PARTIES.**

Entire Form Must Be Completed If a Submitted Bid Is To Be Considered For Award

BIDDER:

<u>Mondi Construction Inc</u> Company Name	<u>May 10, 2012</u> Date
<u>390 E DEVON AVE</u> Street Address of Company	<u>Mondi-construction@yahoo.com</u> E-mail Address
<u>ROSELLE, IL 60172</u> City, State, Zip	<u>NICK RAIMONDI</u> Contact Name (Print)
<u>(630)675-4143</u> Business Phone	<u>(630)675-6332</u> 24-Hour Telephone
<u>(630)562-2344</u> Business Fax	<u>[Signature]</u> Signature of Officer, Partner or Sole Proprietor
ATTEST: if a Corporation	<u>NICK RAIMONDI</u> Print Name & Title
<u>[Signature]</u> Signature of Corporation Secretary	

We hereby agree to furnish the Village of Downers Grove all necessary materials, equipment, labor, etc. to complete the project within **30** calendar days from the date of the Notice to Proceed in accordance with the provisions, instructions and specifications for the unit prices shown on the Schedule of Prices.

VILLAGE OF DOWNERS GROVE:

ATTEST:

Authorized Signature

Village Clerk

Title

Date

Date

In compliance with the specifications, the above-signed offers and agrees, if this Bid is accepted within 90 calendar days from the date of opening, to furnish any or all of the services upon which prices are quoted, at the price set opposite each item, delivered at the designated point within the time specified above.

V. BID and CONTRACT FORM (Contractor)

*****THIS BID WHEN ACCEPTED AND SIGNED BY AN AUTHORIZED SIGNATORY OF THE VILLAGE OF DOWNERS GROVE SHALL BECOME A CONTRACT BINDING UPON BOTH PARTIES.**

Entire Form Must Be Completed If a Submitted Bid Is To Be Considered For Award

BIDDER:

<u>Mondi Construction Inc</u> Company Name	<u>May 10 2012</u> Date
<u>390 E Devon Ave</u> Street Address of Company	<u>Mondi_Construction@yahoo.com</u> E-mail Address
<u>ROSELLE, IL 60172</u> City, State, Zip	<u>NICK RAIMONDI</u> Contact Name (Print)
<u>(630) 675-4143</u> Business Phone	<u>(630) 675-6332</u> 24-Hour Telephone
<u>(630) 562-2344</u> Business Fax	<u>Nick Raimondi</u> Signature of Officer, Partner or Sole Proprietor
ATTEST: if a Corporation <u>Nick Raimondi</u> Signature of Corporation Secretary	<u>NICK RAIMONDI president</u> Print Name & Title

We hereby agree to furnish the Village of Downers Grove all necessary materials, equipment, labor, etc. to complete the project within 30 calendar days from the date of the Notice to Proceed in accordance with the provisions, instructions and specifications for the unit prices shown on the Schedule of Prices.

VILLAGE OF DOWNERS GROVE:

ATTEST:

Authorized Signature

Village Clerk

Title

Date

Date

In compliance with the specifications, the above-signed offers and agrees, if this Bid is accepted within 90 calendar days from the date of opening, to furnish any or all of the services upon which prices are quoted, at the price set opposite each item, delivered at the designated point within the time specified above.

SCHEDULE OF PRICES:

ITEM NO.	ITEMS	UNIT	QTY	UNIT COST	TOTAL COST
70103900	TRAFFIC CONTROL, MAINTENANCE OF TRAFFIC, DETOURS	LS	1	\$ 2,500.00	\$ 2,500.00
42400430	PORTLAND CEMENT CONCRETE SIDEWALK 5 INCH, SPECIAL	SF	20,000	\$ 4.45	\$ 89,000.00
*N/A	PORTLAND CEMENT CONCRETE SIDEWALK 5 INCH (COLORED)	SF	1,000	\$ 12.00	\$ 12,000.00
42400800	DETECTABLE WARNINGS	SF	575	\$ 14.98	\$ 8,613.50
44001700	COMBINATION CONCRETE CURB AND GUTTER REMOVAL AND REPLACEMENT	LF	170	\$ 17.50	\$ 2,975.00
60100905	PIPE DRAINS 4"	LF	50	\$ 40.00	\$ 2,000.00
60255500	MANHOLES TO BE ADJUSTED	EA	4	\$ 385.00	\$ 1,540.00
*N/A	P.C.C. DRIVEWAY REMOVAL AND REPLACEMENT	SY	110	\$ 48.00	\$ 5,280.00
Z0004510	HOT-MIX DRIVEWAY PAVEMENT, 3" (SPECIAL)	SY	40	\$ 51.00	\$ 2,040.00
XX001064	TREE ROOT PRUNING	EA	10	\$ 200.00	\$ 2,000.00
56500600	DOMESTIC WATER SERVICE BOXES TO BE ADJUSTED	EA	13	\$ 198.00	\$ 2,574.00

TOTAL BID \$ 130,522.50

BIDDER'S CERTIFICATION (page 1 of 3)

With regard to 2012 Replacement Sewer Program Bidder Mondi Construction Inc
(Name of Project) (Name of Bidder)

hereby certifies the following:

1. Bidder is not barred from bidding this Contract as a result of violations of Section 720 ILCS 5/33E-3 (Bid Rigging) or 720 ILCS 5/33E-4 (Bid-Rotating);
2. Bidder certifies that it has a written sexual harassment policy in place and full compliance with 775 ILCS 5/2-105(A)(4);
3. Bidder certifies that not less than the prevailing rate of wages as determined by the Village of Downers Grove, DuPage County or the Illinois Department of Labor shall be paid to all laborers, workers and mechanics performing work for the Village of Downers Grove. All bonds shall include a provision as will guarantee the faithful performance of such prevailing wage clause. Bidder agrees to comply with the Illinois Prevailing Wage Act, 820 ILCS 130/1 *et seq.*, for all work completed. Bidder agrees to pay the prevailing wage and require that all of its subcontractors pay prevailing wage to any laborers, workers or mechanics who perform work pursuant to this Contract or related subcontract. Bidder and each subcontractor shall keep or cause to be kept an accurate record of names, occupations and actual wages paid to each laborer, workman and mechanic employed by the Bidder in connection with the contract. This record shall be sent to the Village on a monthly basis along with the invoice and shall be open to inspection at all reasonable hours by any representative of the Village or the Illinois Department of Labor and must be preserved for four (4) years following completion of the contract. Bidder certifies that Bidder and any subcontractors working on the project are aware that filing false payroll records is a Class A misdemeanor and that the monetary penalties for violations are to be paid pursuant to law by the Bidder, contractor and subcontractor. The Village shall not be liable for any underpayments. If applicable: Since this is a contract for a fixed public works project, as defined in 820 ILCS 130/2, Contractor agrees to post at the job site in an easily accessible place, the prevailing wages for each craft or type of worker or mechanic needed to execute the contract or work to be performed;
4. Bidder certifies that it is in full compliance with the Federal Highway Administrative Rules on Controlled Substances and Alcohol Use and Testing, 49 C.F.R. Parts 40 and 382 and that all employee drivers are currently participating in a drug and alcohol testing program pursuant to the Rules;
5. Bidder further certifies that it is not delinquent in the payment of any tax administered by the Department of Revenue, or that Bidder is contesting its liability for the tax delinquency or the amount of a tax delinquency in accordance with the procedures established by the appropriate Revenue Act. Bidder further certifies that if it owes any tax payment(s) to the Department of Revenue, Bidder has entered into an agreement with the Department of Revenue for the payment of all such taxes that are due, and Bidder is in compliance with the agreement.

BIDDER'S CERTIFICATION (page 2 of 3)

BY: Nick Raimondi
Bidder's Authorized Agent

45-0668698

FEDERAL TAXPAYER IDENTIFICATION NUMBER

or _____
Social Security Number



Subscribed and sworn to before me
this 10th day of May, 2014.
Carmela Raimondi
Notary Public

(Fill Out Applicable Paragraph Below)

(a) Corporation

The Bidder is a corporation organized and existing under the laws of the State of Illinois, which operates under the Legal name of Mardi Construction Inc, and the full names of its Officers are as follows:

President: Nick Raimondi
Secretary: Nick Raimondi
Treasurer: Nick Raimondi

and it does have a corporate seal. (In the event that this bid is executed by other than the President, attach hereto a certified copy of that section of Corporate By-Laws or other authorization by the Corporation which permits the person to execute the offer for the corporation.)

(b) Partnership

Signatures and Addresses of All Members of Partnership:

BIDDER'S CERTIFICATION (page 3 of 3)

The partnership does business under the legal name of: _____
which name is registered with the office of _____ in the state of _____

(c) Sole Proprietor

The Bidder is a Sole Proprietor whose full name is: _____
and if operating under a trade name, said trade name is: _____
which name is registered with the office of _____ in the state of _____

6. Are you willing to comply with the Village's insurance requirements within 13 days of the award of the contract? YES

INSURER'S NAME: Columbian Agency

AGENT: Kevin Scanlon

Street Address: 1005 Laraway Road

City, State, Zip Code: New Lenox, IL 60451

Telephone Number: (815) 215-4711

I/We hereby affirm that the above certifications are true and accurate and that I/we have read and understand them.

Print Name of Company: Mondi Construction Inc

Print Name and Title of Authorizing Signature: Nick Raimondi president

Signature: Nick Raimondi

Date: May 10, 2011

MUNICIPAL REFERENCE LIST

Municipality: Village of Streamwood
Address: 565 S Bartlett Rd Streamwood IL 60107
Contact Name: MAH MANN Phone #: (630) 736-3850
Name of Project: 2010 Sidewalk Program
Contract Value: \$750,000⁰⁰ Date of Completion: 2010

Municipality: Ledcor Construction Inc
Address: 17 W 635 Butterfield Rd
Contact Name: MIKE Phone #: (630) 261-4119
Name of Project: Children of America Orland Park
Contract Value: \$45,000⁰⁰ Date of Completion: 2011

Municipality: Chicago Land (City of Evanston) ^{paving work at}
Address: 225 Telsa Rd Lake Zurich IL 60047
Contact Name: Bill Phone #: (847) 550-9681
Name of Project: 2011 MFT Program
Contract Value: \$200,000⁰⁰ Date of Completion: 2011

Municipality: Focus Construction Inc
Address: 211 Waukegan Rd. Suite 220 Northfield, IL 60063
Contact Name: Rich Phone #: (847) 441-0474
Name of Project: Vite Building Vernon Hills, IL
Contract Value: \$48,000⁰⁰ Date of Completion: 2011

Municipality: King Concrete, Inc
Address: P.O. Box 1965 Arlington Heights IL 60006
Contact Name: Mark Bucci Phone #: (847) 537-5700
Name of Project: ROHRMAN Auto Arlington Hts program
Contract Value: \$200,000⁰⁰ Date of Completion: 2011

SUBCONTRACTORS LIST

The Bidder hereby states the following items of work will not be performed by its organization. (List items to be subcontracted as well as the names, addresses and phone numbers of the subcontractors.)

1) N/A Type of Work _____

Addr: _____ City _____ State _____ Zip _____

2) _____ Type of Work _____

Addr: _____ City _____ State _____ Zip _____

3) _____ Type of Work _____

Addr: _____ City _____ State _____ Zip _____

4) _____ Type of Work _____

Addr: _____ City _____ State _____ Zip _____

5) _____ Type of Work _____

Addr: _____ City _____ State _____ Zip _____

6) _____ Type of Work _____

Addr: _____ City _____ State _____ Zip _____

7) _____ Type of Work _____

Addr: _____ City _____ State _____ Zip _____

8) _____ Type of Work _____

Addr: _____ City _____ State _____ Zip _____



VENDOR W-9 REQUEST FORM

The law requires that we maintain accurate taxpayer identification numbers for all individuals and partnerships to whom we make payments, because we are required to report to the I.R.S all payments of \$600 or more annually. We also follow the I.R.S. recommendation that this information be maintained for all payees including corporations.

Please complete the following substitute W-9 letter to assist us in meeting our I.R.S. reporting requirements. The information below will be used to determine whether we are required to send you a Form 1099. Please respond as soon as possible, as failure to do so will delay our payments.

BUSINESS (PLEASE PRINT OR TYPE):

NAME: Monte Construction Inc
ADDRESS: 390 E Devon Ave
CITY: Roselle, IL 60172
STATE: Illinois
ZIP: 60172
PHONE: (630) 675-4143 FAX: (630) 562-2344
TAX ID #(TIN): 45-0668698

(If you are supplying a social security number, please give your full name)

REMIT TO ADDRESS (IF DIFFERENT FROM ABOVE):

NAME: SAME AS ABOVE
ADDRESS: _____
CITY: _____
STATE: _____ ZIP: _____

TYPE OF ENTITY (CIRCLE ONE):

- Individual
- Sole Proprietor
- Partnership
- Medical
- Charitable/Nonprofit
- Limited Liability Company - Individual/Sole Proprietor
- Limited Liability Company-Partnership
- Limited Liability Company-Corporation
- Corporation
- Government Agency

SIGNATURE: [Signature] DATE: May 10, 2012

Apprenticeship and Training Certification

(Does not apply to federal aid projects. Applicable only to maintenance and construction projects that use Motor Fuel Tax funds or state grant monies.)

Name of Bidder: Mondi Construction Inc

In accordance with the provisions of Section 30-22 (6) of the Illinois Procurement Code, the Bidder certifies that it is a participant, either as an individual or as part of a group program, in the approved apprenticeship and training programs applicable to each type of work or craft that the bidder will perform with its own forces. The Bidder further certifies for work that will be performed by subcontract that each of its subcontractors submitted for approval either (a) is, at the time of such bid, participating in an approved, applicable apprenticeship and training program; or (b) will, prior to commencement of performance of work pursuant to this Contract, begin participation in an approved apprenticeship and training program applicable to the work of the subcontract. The Illinois Department of Labor, at any time before or after award, may require the production of a copy of each applicable Certificate of Registration issued by the United States Department of Labor evidencing such participation by the contractor and any or all of its subcontractors. Applicable apprenticeship and training programs are those that have been approved and registered with the United States Department of Labor. The Bidder shall list in the space below, the official name of the program sponsor holding the Certificate of Registration for all of the types of work or crafts in which the Bidder is a participant and that will be performed with the Bidder's forces. Types of work or craft work that will be subcontracted shall be included and listed as subcontract work. The list shall also indicate any type of work or craft job category that does not have an applicable apprenticeship or training program. **The Bidder is responsible for making a complete report and shall make certain that each type of work or craft job category that will be utilized on the project is accounted for and listed. Return this with the Bid.**

Local # 803	Registered as part of the National	Apprenticeship program		
Local # 502	"	"	"	"
Local # 46	"	"	"	"
Local # 150	"	"	"	"

The requirements of this certification and disclosure are a material part of the Contract, and the Contractor shall require this certification provision to be included in all approved subcontracts. In order to fulfill this requirement, it shall not be necessary that an applicable program sponsor be currently taking or that it will take applications for apprenticeship, training or employment during the performance of the work of this Contract.

Print Name and Title of Authorizing Signature: Nick Raimondi president

Signature: [Handwritten Signature]

Date: May 10, 2012

BUY AMERICA CERTIFICATION

Certification requirement for procurement of steel, iron, or manufactured products when Federal funds (Grant Agreement or Cooperative Agreement) are used.

Instructions:

Bidder to complete the Buy America Certification listed below. Bidder shall certify EITHER COMPLIANCE OR NON-COMPLIANCE (not both). This Certification MUST BE submitted with the Bidder's bid response.

Special Note: Make sure you have signed only one of the above statements – either Compliance OR Non-Compliance (not both).

Certificate of Compliance

The bidder or offeror hereby certifies that it will meet the requirements of 49 U.S.C. 5323(j)(1), as amended, and the applicable regulations in 49 CFR Part 661.

Signature Neil S. [Signature]

Company Name Mandi Construction Inc

Title President

Date May 10, 2011

Certificate of Non-Compliance

The bidder or offeror hereby certifies that it cannot comply with the requirements of 49 U.S.C. 5323(j)(1), as amended, and 49 C.F.R. 661, but it may qualify for an exception pursuant to 49 U.S.C. 5323(j)(2)(A), 5323(j)(2)(B), or 5323(j)(2)(D), and 49 C.F.R. 661.7.

Signature _____

Company Name _____

Title _____

Date _____

AFTER THIS CERTIFICATE HAS BEEN EXECUTED, A BIDDER MAY NOT SEEK A WAIVER.

Note: The U.S./Canadian Free Trade Agreement does not supersede the Buy America requirement.

Suspension or Debarment Certificate

Non-Federal entities are prohibited from contracting with or making sub-awards under covered transactions to parties that are suspended or debarred or whose principals are suspended or debarred. Covered transactions include procurement for goods or services equal to or in excess of \$100,000.00. Contractors receiving individual awards for \$100,000.00 or more and all sub-recipients must certify that the organization and its principals are not suspended or debarred.

By submitting this offer and signing this certificate, the Bidder certifies to the best of its knowledge and belief, that the company and its principals:

1. Are not presently debarred, suspended, proposed for debarment, declared ineligible or voluntarily excluded from covered transactions by any federal, state or local governmental entity, department or agency;
2. Have not within a three-year period preceding this Bid been convicted of or had a civil judgment rendered against them for commission of fraud or a criminal offense in connection with obtaining, attempting to obtain, or performing a public (Federal, State or local) transaction or contract under a public transaction, or convicted of or had a civil judgment against them for a violation of Federal or state antitrust statutes or commission of embezzlement, theft, forgery, bribery, falsification or destruction of records, making false statements, or receiving stolen property;
3. Are not presently indicted for or otherwise criminally or civilly charged by a governmental entity (Federal, State, or local) with commission of any of the offenses enumerated in paragraph (2) of this certification; and
4. Have not within a three-year period preceding this application/proposal/contract had one or more public transactions (Federal, State or local) terminated for cause or default.

If the Bidder is unable to certify to any of the statements in this certification, Bidder shall attach an explanation to this certification.

Company Name: Mondi Construction Inc

Address: 390 E DEVON AVE

City: ROSELLE, IL Zip Code: 600172

Telephone: (630) 675-4143 Fax Number: (630) 562-2344

E-mail Address: Mondi-Construction@yahoo.com

Authorized Company Signature: Nick Raimondi

Print Signature Name: Nick Raimondi Title of Official: president

Date: May 10, 2014

CAMPAIGN DISCLOSURE CERTIFICATE

Any contractor, proposer, bidder or vendor who responds by submitting a bid or proposal to the Village of Downers Grove shall be required to submit with its bid submission, an executed Campaign Disclosure Certificate.

The Campaign Disclosure Certificate is required pursuant to the Village of Downers Grove Council Policy on Ethical Standards and is applicable to those campaign contributions made to any member of the Village Council.

Said Campaign Disclosure Certificate requires any individual or entity bidding to disclose campaign contributions, as defined in Section 9-1.4 of the Election Code (10 ILCS 5/9-1.4), made to current members of the Village Council within the five (5) year period preceding the date of the bid or proposal release.

By signing the bid documents, contractor/proposer/bidder/vendor agrees to refrain from making any campaign contributions as defined in Section 9-1.4 of the Election Code (10 ILCS 5/9-1.4) to any Village Council member and any challengers seeking to serve as a member of the Downers Grove Village Council.

Under penalty of perjury, I declare:

Bidder/vendor has not contributed to any elected Village position within the last five (5) years.

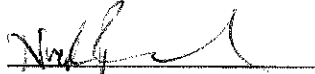
Signature

Nick Palmondu
Print Name

Bidder/vendor has contributed a campaign contribution to a current member of the Village Council within the last five (5) years.

Print the following information:

Name of Contributor: _____
(company or individual)

To whom contribution was made: _____

Year contribution made: _____ Amount: \$ _____

Signature

Print Name

BID SUBMITTAL CHECKLIST

Each Bidder's Bid Package must be submitted with all requisite forms properly completed, and all documentation included. The following list is not all-inclusive, but is designed to facilitate a good, competitive bidding environment.

1. Instructions to Bidders read and understood. Any questions must be asked according to the instructions.
2. Cover sheet filled-in
3. Bid Form copies filled-in. All copies must have original signatures and seals on them.
4. Bid Bond or cashier's check enclosed with bid package.
5. Schedule of Prices completed. Check your math!
6. Bidder Certifications signed and sealed.
7. Letter from Surety ensuring issuance of Performance and Labor Bonds.
8. Letter from Insurance Agent or Carrier ensuring issuance of required job coverage.
9. Municipal Reference List completed.
10. Vendor request form W-9 completed.
11. Affidavit (IDOT Form BC-57, or similar).
12. Bid package properly sealed and labeled before delivery. If sending by mail or messenger, enclose in a second outer envelope or container. Project plan sheets do not have to be included with the bid package.

2012 Calendar of Events

Downtown Market

May 12- October 20 (Saturday)

June 23, 2012 Market to be held on Main Street between Maple Ave. and Curtiss St.

Summer Nights Classic Car Show

May 18-August 31(Friday)

Memorial Day Parade

May 28 (Monday)

Family Concert Series

June 5 - August 7 (Tuesday)

Grove Fest (Sponsored by the DG Rotary Club)

June 21-June 24 (Thurs.- Sun.)

Independence Day Parade

July 4 (Wednesday), 12:45PM

Bike and Buggy Parade

Downtown Sidewalk Sale

July 19-22 (Thursday through Sunday)

Fine Arts Festival

September 8 and 9 (Saturday and Sunday)

Girls Night Out

September 27 (Thursday)

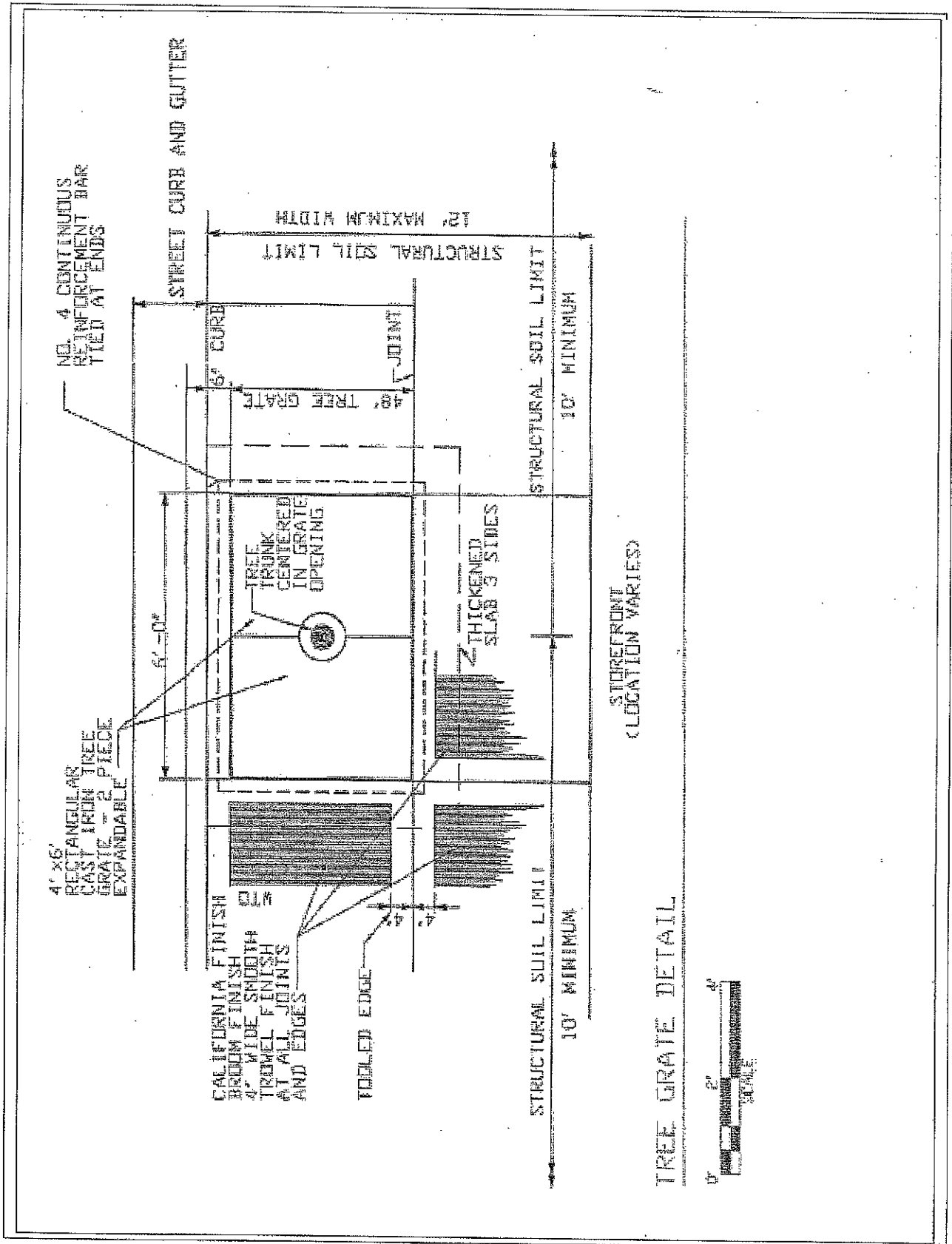

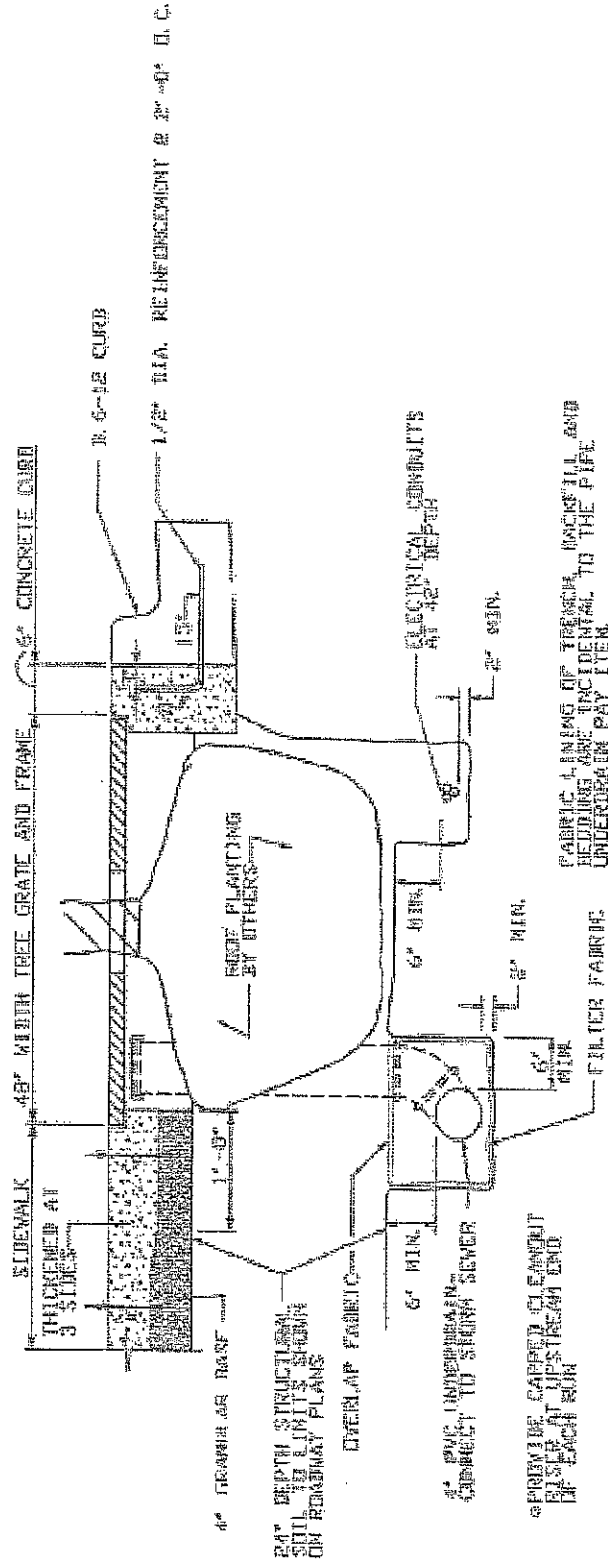

SECTION THROUGH TREE PIT PERPENDICULAR TO STREET

SCALE: 1" = 1'-0"

ALL CONSTRUCTION MATERIALS AND METHODS SHALL COMPLY WITH THE "STANDARDS SPECIFICATION FOR ROAD & BRIDGE CONSTRUCTION" AS ADOPTED BY THE ILLINOIS DEPT. OF TRANSPORTATION UNLESS OTHERWISE SPECIFIED HEREIN

ABSOLUTELY NO CHLORIDE ACCELERANT OR WIRE MESH WILL BE PERMITTED

TYPICAL SIDEWALK PLACEMENT IN R.O.W.

PLACE 1/2" PRE-MOLDED EXPANSION JOINT WHERE ABUTTING EXISTING CONC. BOTH SIDES OF UTILITY STRUCTURE @ EVERY 50' O.C.

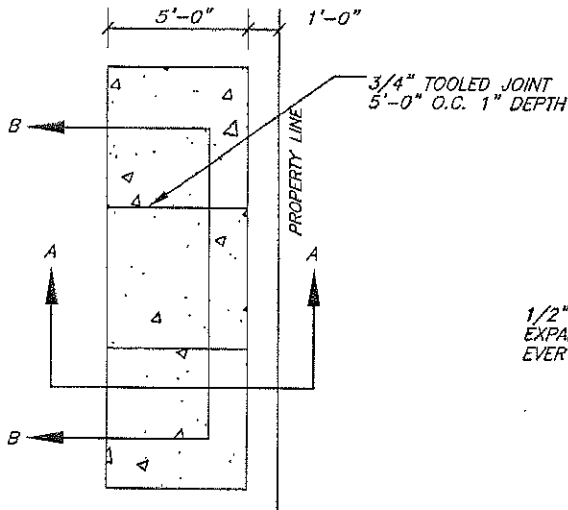

MAX RUNNING SLOPE = 5% (1:20) OR MATCH EXIST GRADE OF THE STREET

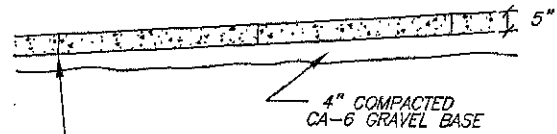

SECTION B-B

SAW CUT EXISTING CURB PERPENDICULAR TO BACK 6" FROM EDGE OF WALK UNLESS CUT FALLS WITHIN 5' OF EXIST. JOINT, REMOVE TO EXIST. JOINT. FOR FURTHER DETAILS SEE CURB & GUTTER SPECIFICATIONS

BARRICADING
PLACE TYPE II BARRICADES WITH FLASHING LIGHTS ON ALL SIDES OF EXCAVATIONS. MAINTAIN BARRICADES FOR MIN. 72 HRS AFTER PLACEMENT

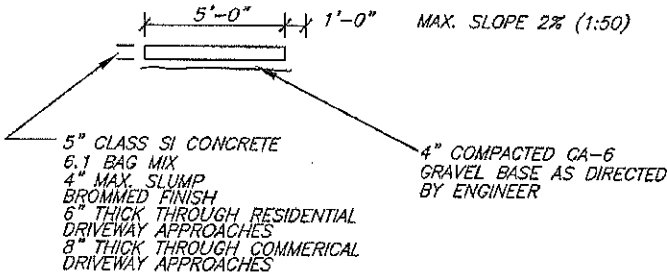

SECTION A-A

N.T.S.	DATE	REVISIONS	DRAWN BY	APPVD BY	STANDARD DETAIL
	02/20/07		D.J.G.		<p>PUBLIC SIDEWALK</p>
	03/25/11		S.A.V.	A.J.S.	
	10/10/11		S.A.V.	A.J.S.	
	05/01/12		T.J.T.		
DRAWING NO. SWK-01					
I:\LIBRARY\DETAILS\SIDEWALK\SWK-01					

DETECTABLE WARNINGS
5' X 2'

UPPER LANDING
5' X 5'
1:50 MAX SLOPE

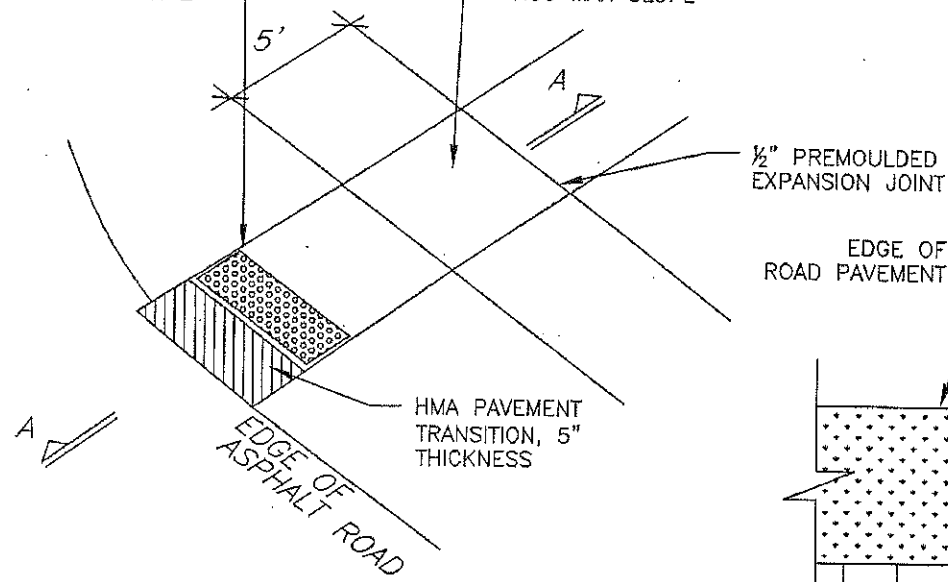

ISOMETRIC VIEW

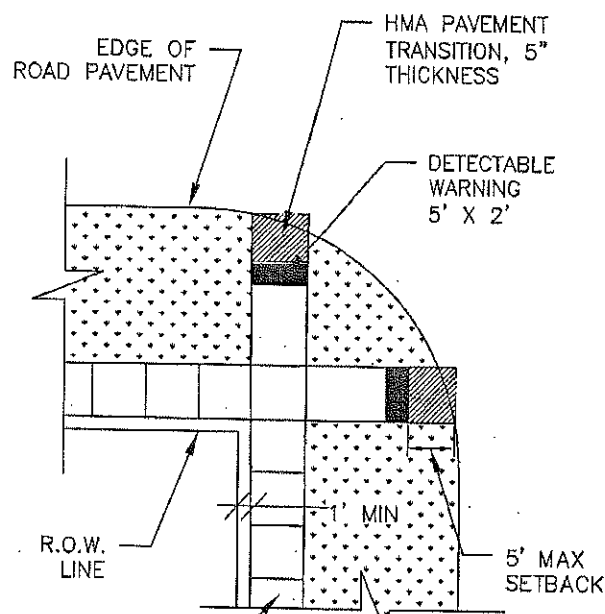

PLAN

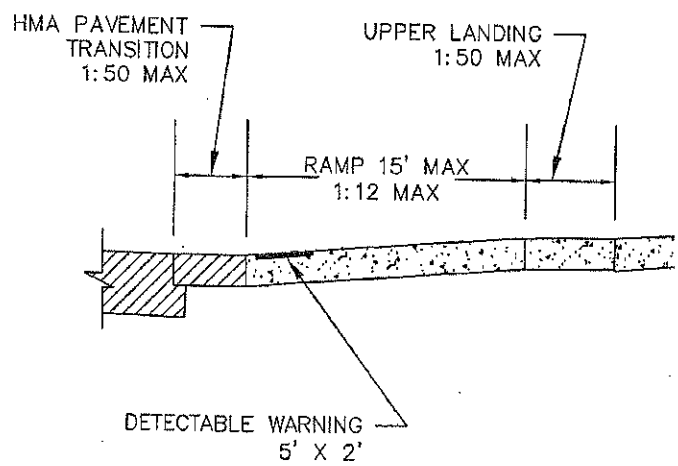



SECTION A-A

INSERT ADA DETECTABLE WARNING SURFACE TILE AS SPECIFIED
DYED CONCRETE NOT ALLOWED

THE TYPE OF DETECTABLE WARNING TILE SHALL BE ARMOR-TILE, CAST IN PLACE SYSTEM, OR ACCESS TILE TACTILE SYSTEMS OR APPROVED EQUAL.

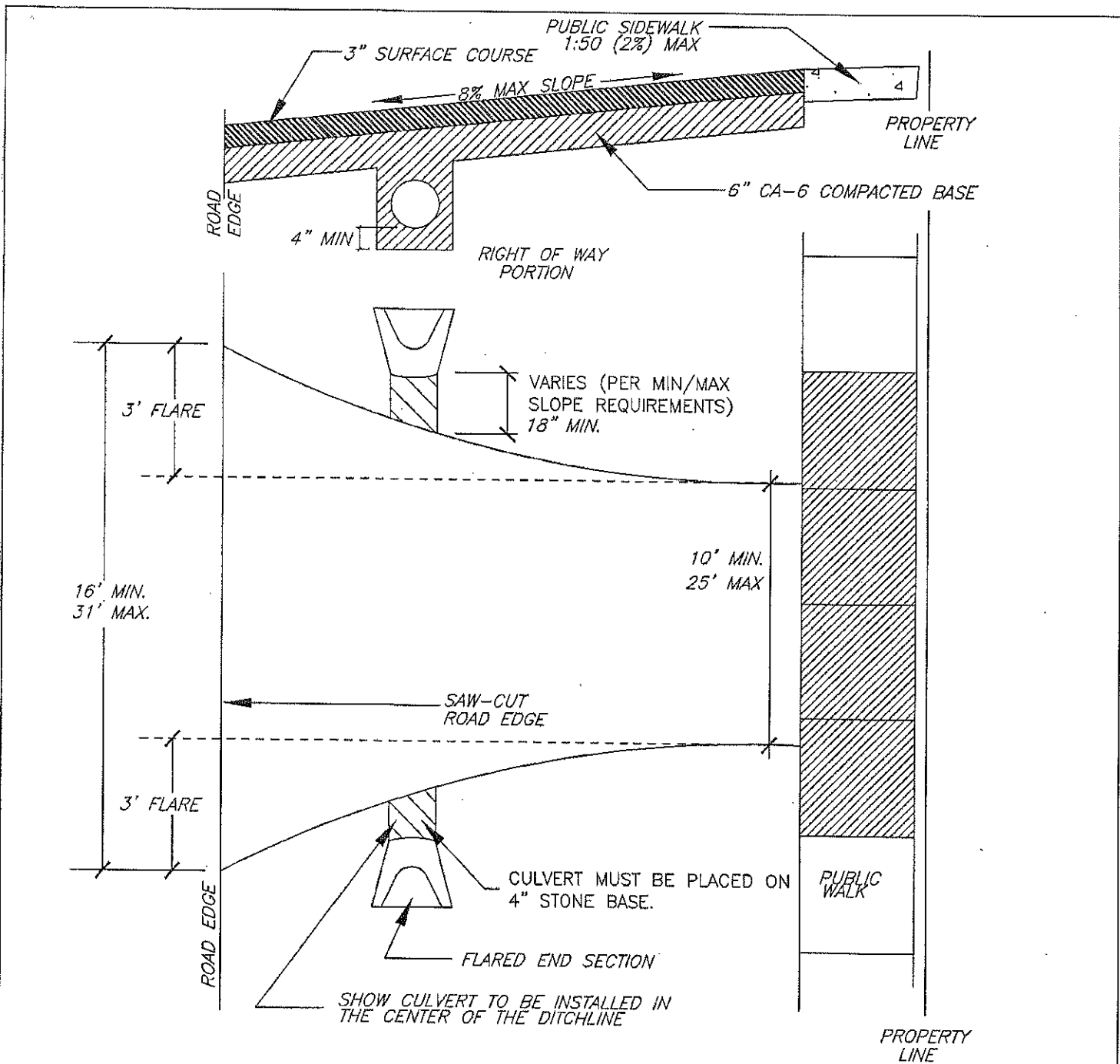
N.T.S.	DATE	REVISIONS	DRAWN BY	APPVD BY	STANDARD DETAIL
	04/12/07		D.J.G.		<p>A.D.A RAMPs ON NON-CURBED STREETS</p>
	03/25/11		S.A.V.	A.J.S.	
	03/26/12		T.J.T.	A.J.S.	
DRAWING NO. SWK-03					
I:\LIBRARY\DETAILS\SIDEWALK\SWK-03					



N.T.S.	DATE	REVISIONS	DRAWN BY	APPVD BY	STANDARD DETAIL
	02/20/07		J.M.L.	M.D.M.	ASPHALT APPROACH ON UNIMPROVED ROADWAY
	03/25/11		S.A.V.	A.J.S.	
	03/26/12		T.J.T.		
DRAWING NO. PVT-01					
I:\LIBRARY\DETAILS\PAVEMENT\PVT-01					

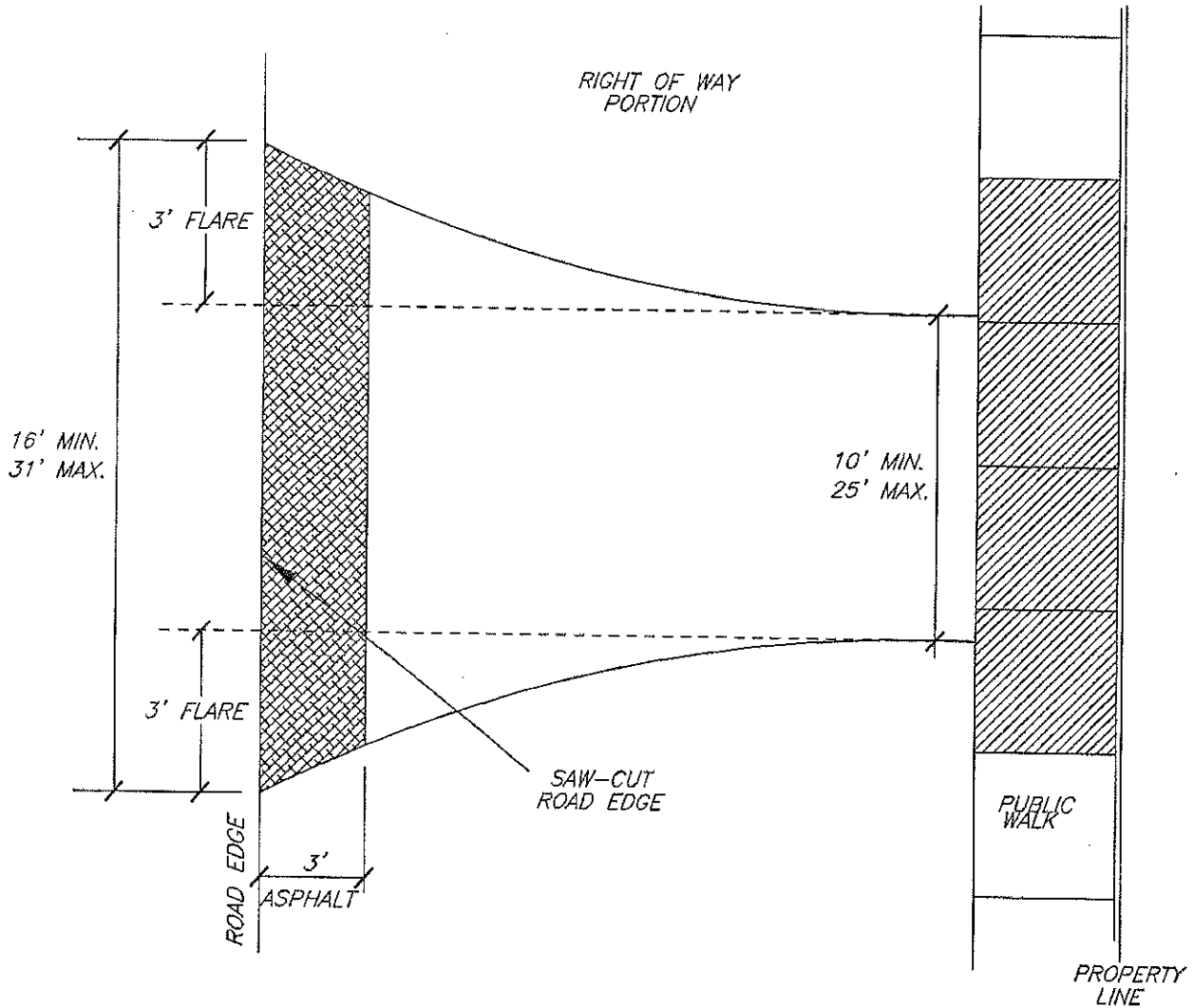
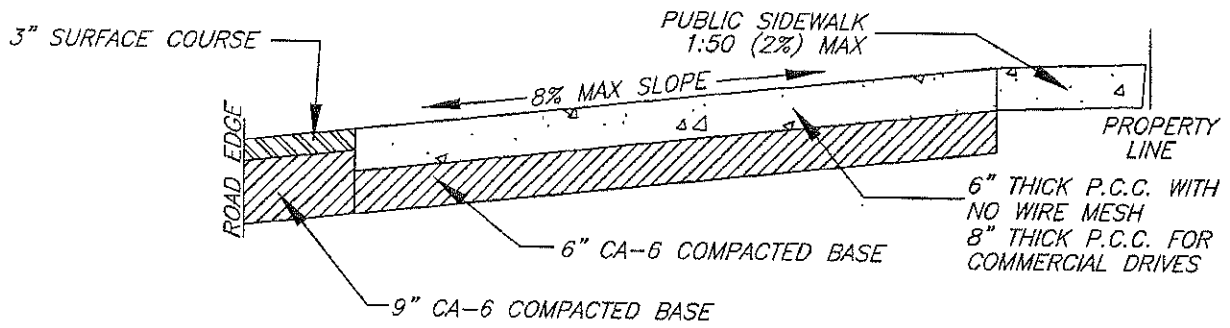

N.T.S.	DATE	REVISIONS	DRAWN BY	APPVD BY	STANDARD DETAIL
	02/20/07		J.M.L.	M.D.M.	CONCRETE APPROACH ON UNIMPROVED ROADWAY
	03/25/11		S.A.V.	A.J.S.	
	03/26/12		T.J.T.		
DRAWING NO. PVT-07					
I:\LIBRARY\DETAILS\PAVEMENT\PVT-07					

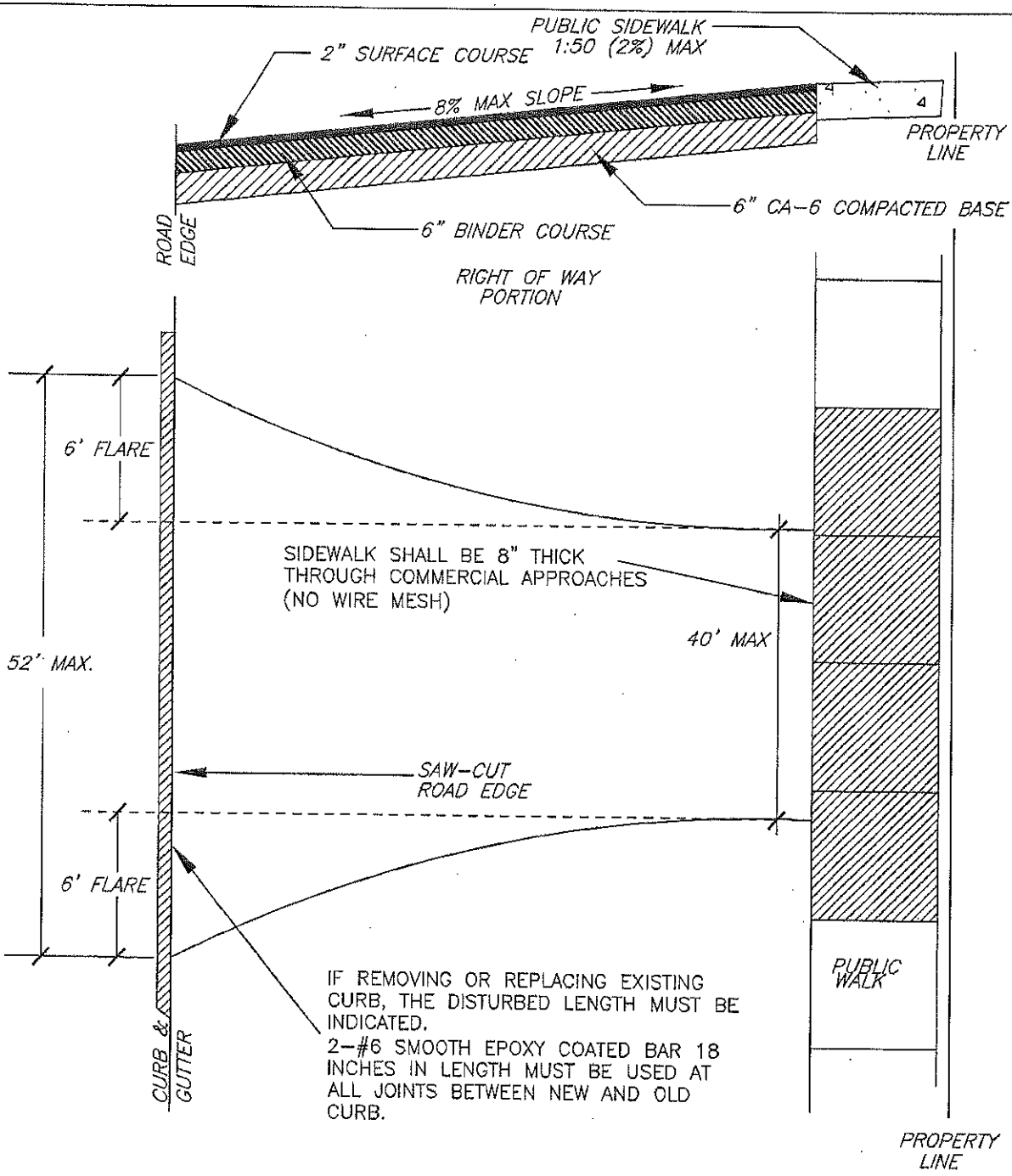

FLARES SHALL BE 6' UNLESS OTHERWISE APPROVED BY THE DIRECTOR OF PUBLIC WORKS
PAVEMENT THICKNESSES SHALL BE AS SHOWN ABOVE, UNLESS OTHERWISE APPROVED BY THE DIRECTOR OF PUBLIC WORKS

N.T.S.	DATE	REVISIONS	DRAWN BY	APPVD BY	STANDARD DETAIL
	03/26/12		T.J.T.		COMMERCIAL ASPHALT APPROACH W/CURB
DRAWING NO. PVT-22					
I:\LIBRARY\DETAILS\PAVEMENT\PVT-22					

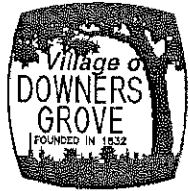

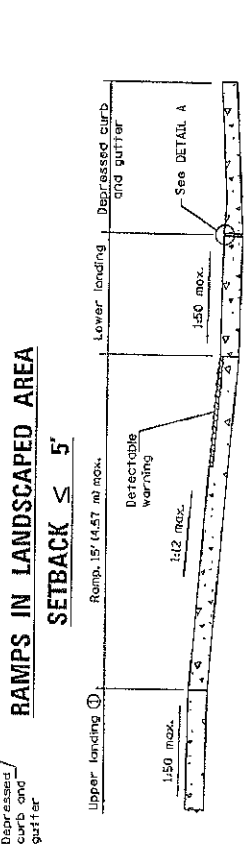
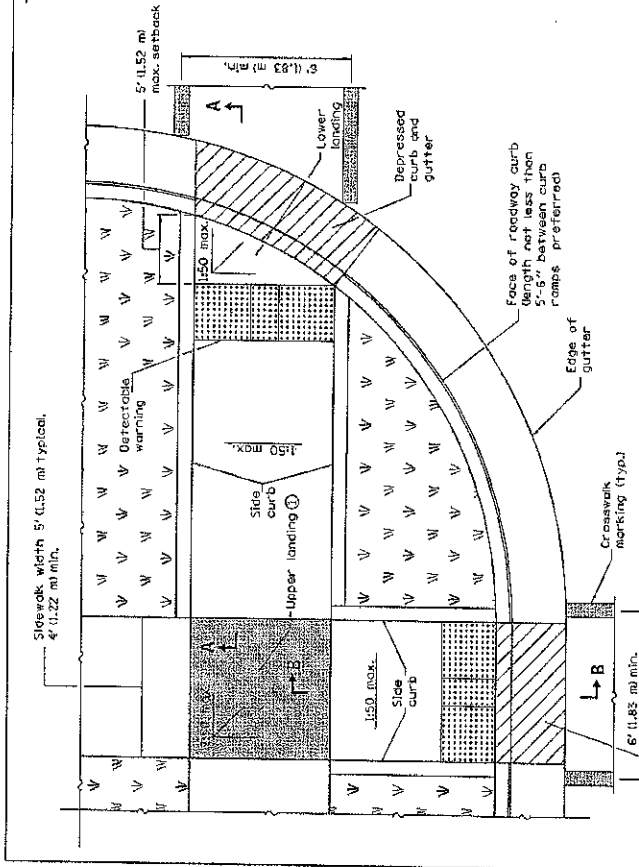
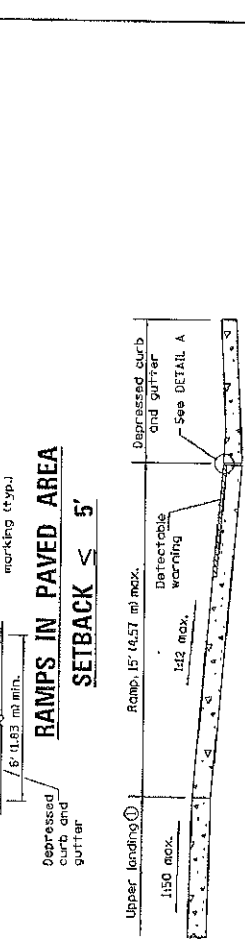
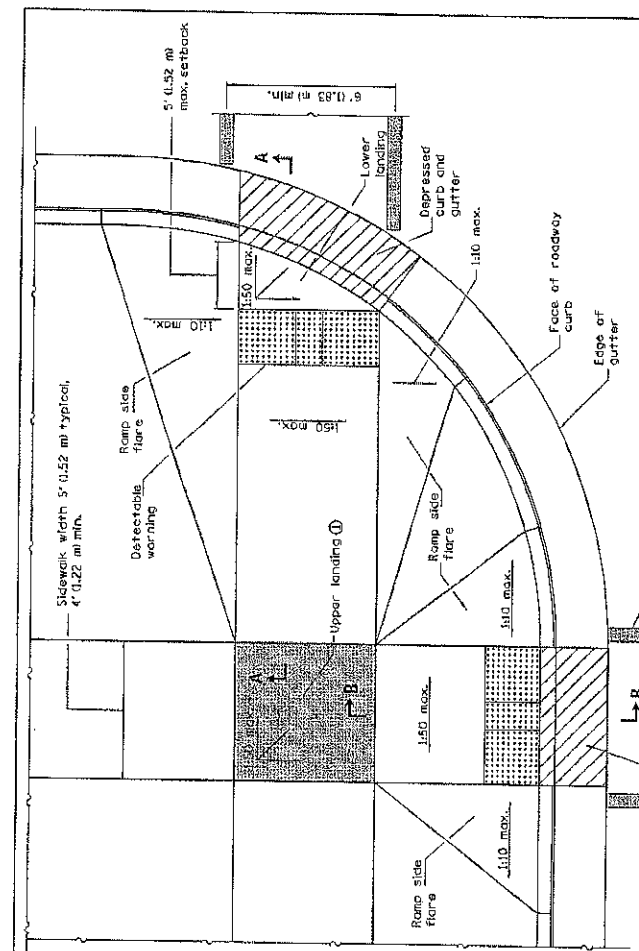

GENERAL NOTES
 All slope ratios are expressed in units of vertical displacement to units of horizontal displacement (V:H).
 See Standard 606001 for details of depressed curb adjacent to curb ramp.
 All dimensions are in inches (millimeters) unless otherwise shown.

SECTION A-A
 Upper landing not required for ramp slopes flatter than 1:20.

SECTION B-B
 Upper landing not required for ramp slopes flatter than 1:20.

PERPENDICULAR CURB RAMPS FOR SIDEWALKS
 (Sheet 1 of 2)
STANDARD 424001-06

DATE	REVISIONS
1-1-12	Completely revised and remained standard.
1-1-08	Switched units to English metrics.

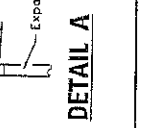
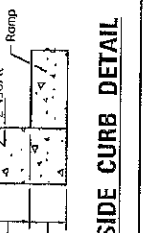

Illinois Department of Transportation	ISSUED 1-1-12
PROJECT 1-002	
DESIGNED BY [Signature]	
ENGINEER OF PUBLIC WORKS	
APPROVED [Signature]	
ENGINEER OF DESIGN AND CONSTRUCTION	

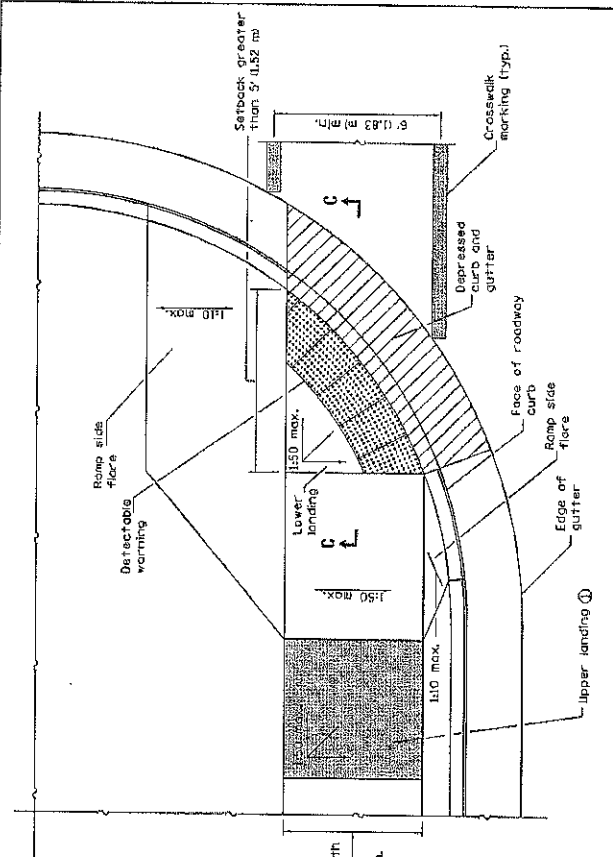

RAMP IN LANDSCAPED AREA
SETBACK > 5'

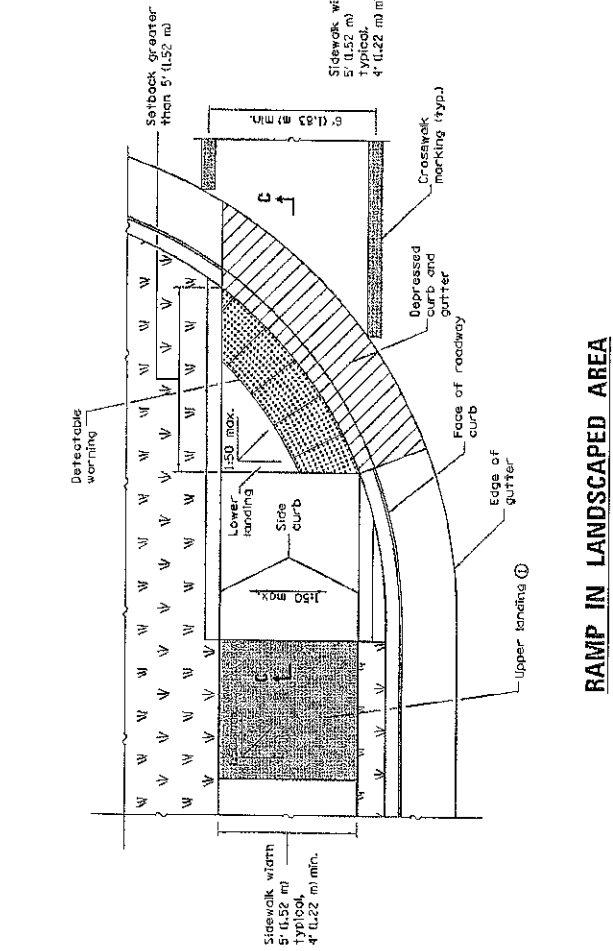

RAMP IN PAVED AREA
SETBACK > 5'

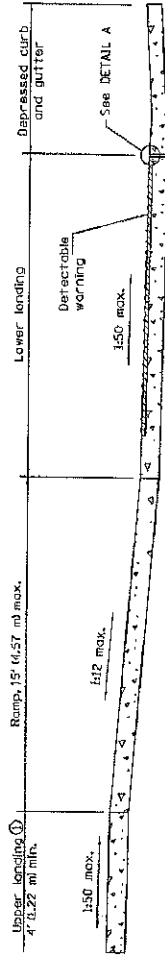

SECTION C-C

① Upper landing not required for ramp slopes flatter than 1:20.

**PERPENDICULAR CURB RAMPS
 FOR SIDEWALKS**
 (Sheet 2 of 2)
 STANDARD 424001-06

Illinois Department of Transportation
 PASSED 2012
 APPROVED 2012
 ENGINEER OF POLICY AND PROCEDURES
 ENGINEER OF DESIGN AND CONSTRUCTION
 ISSUED 1-1-97

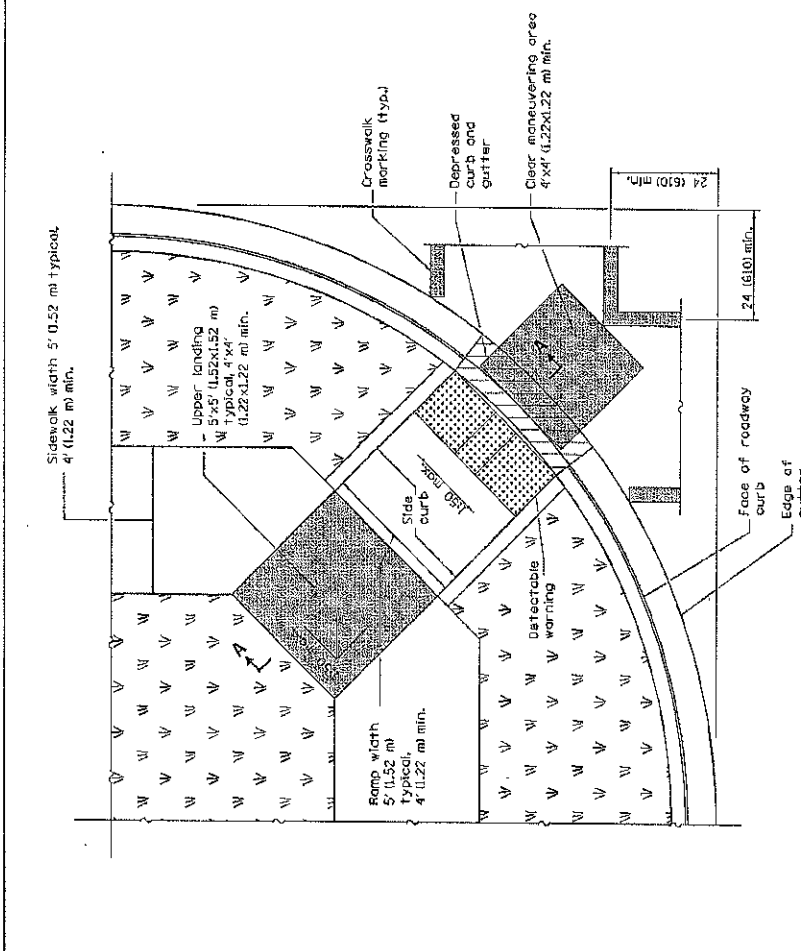
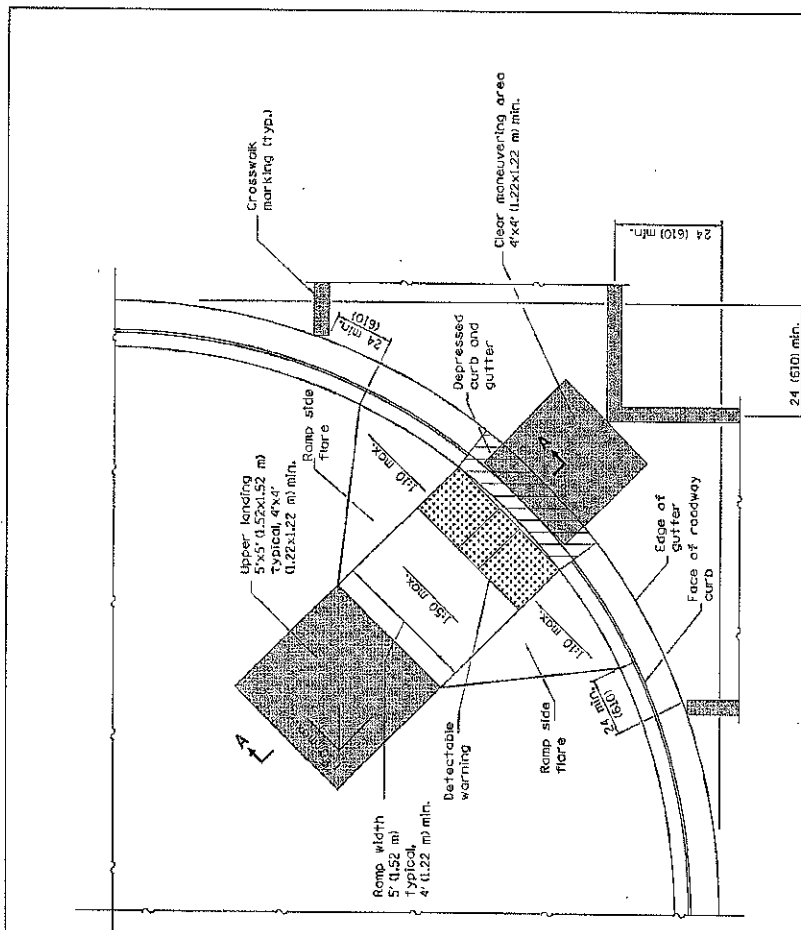

RAMP IN LANDSCAPED AREA

RAMP IN PAVED AREA

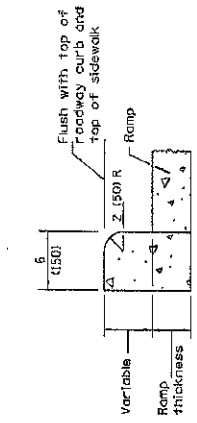

SIDE CURB DETAIL

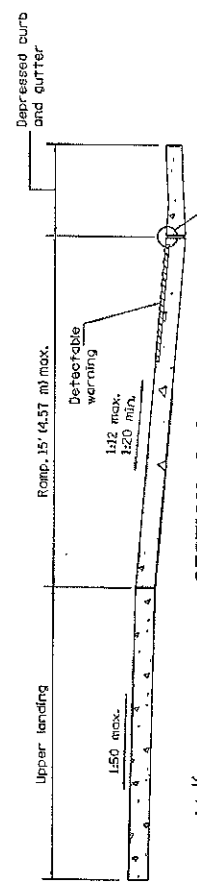

SECTION A-A

GENERAL NOTES
 This Standard shall only be used for curb radii of 20 ft. (6.1 m) or greater.
 All slope ratios are expressed as units of vertical displacement to units of horizontal displacement (V:H).
 See Standard 606.001 for details of depressed curb adjacent to curb ramp.
 All dimensions are in inches (millimeters) unless otherwise shown.

Illinois Department of Transportation	
PASSED	ISSUED 1-1-12
APPROVED	APPROVED
ENGINEER OF POLICY AND PROCEDURES	ENGINEER OF DESIGN AND ENVIRONMENT

DATE	REVISIONS
1-1-12	New Standard

DIAGONAL CURB RAMPS FOR SIDEWALKS
 STANDARD 424006

Sidewalk width
5' (1.52 m) typical,
4' (1.22 m) min.

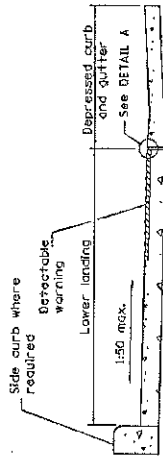
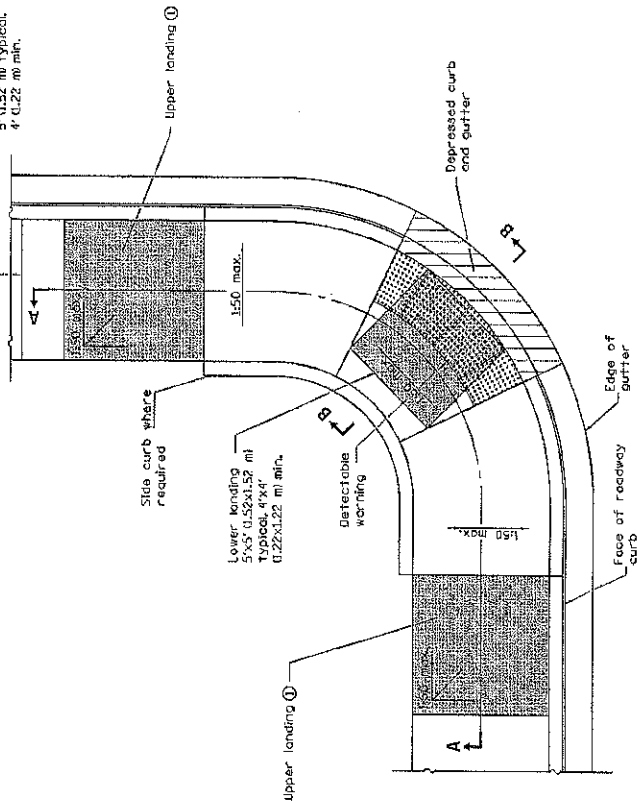

SECTION B-B

CORNER PARALLEL CURB RAMP

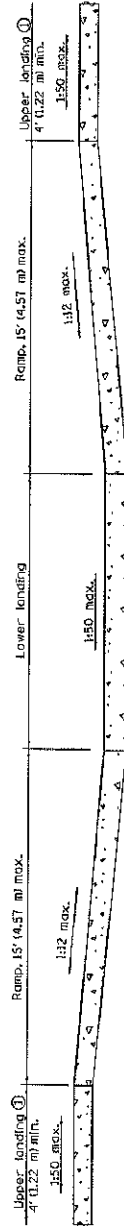

SECTION A-A

① Upper landings not required for ramp slopes flatter than 1:20.

GENERAL NOTES

All slope ratios are expressed as units of vertical displacement to units of horizontal displacement (V:H).

See Standard 506003 for details of depressed curb adjacent to curb ramp.

All dimensions are in inches (millimeters) unless otherwise shown.

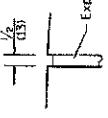

DETAIL A

Flush with top of roadway curb and top of sidewalk

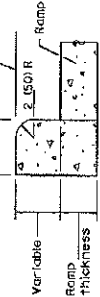

SIDE CURB DETAIL

DATE	REVISIONS
1-1-12	New standard.

CORNER PARALLEL CURB RAMPS FOR SIDEWALKS

STANDARD 424011

Illinois Department of Transportation
 PASSED January 1, 2012
 ENGINEER OF SAFETY AND PROCEDURES
 APPROVED January 1, 2012
 ENGINEER OF DESIGN AND ENVIRONMENT

CS500 1-1-12

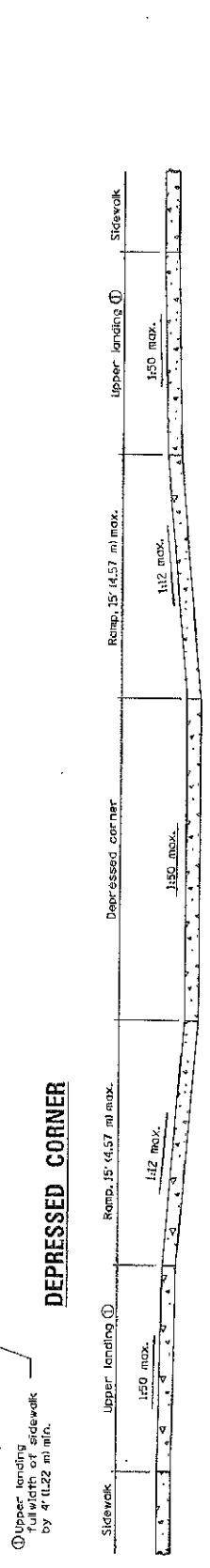
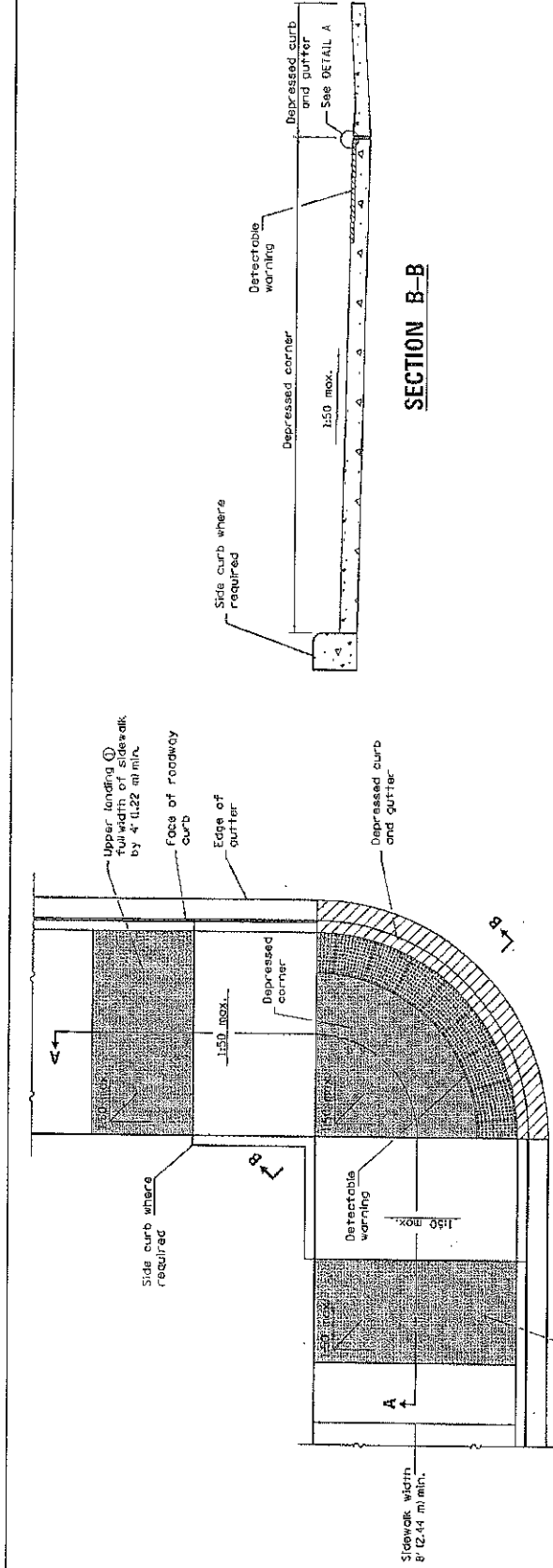

SECTION A-A
 ① Upper landings not required for ramp slopes flatter than 1:20.

GENERAL NOTES
 All slope ratios are expressed as units of vertical displacement to units of horizontal displacement (V:H).
 See Standard 806001 for details of depressed curb adjacent to curb ramp.
 All dimensions are in inches (millimeters) unless otherwise shown.

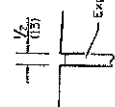
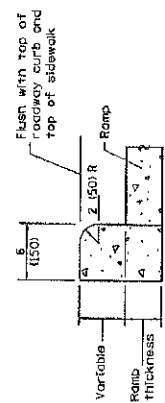

Iowa Department of Transportation		ISSUED 3-1-12
DRAWN BY M. D. B.	DATE 2012	
APPROVED BY M. D. B.	DATE 2012	
ENGINEER OF DESIGN AND SURVEYMENT		

DATE	REVISIONS
1-1-12	New standard.

DEPRESSED CORNER FOR SIDEWALKS

STANDARD 424021

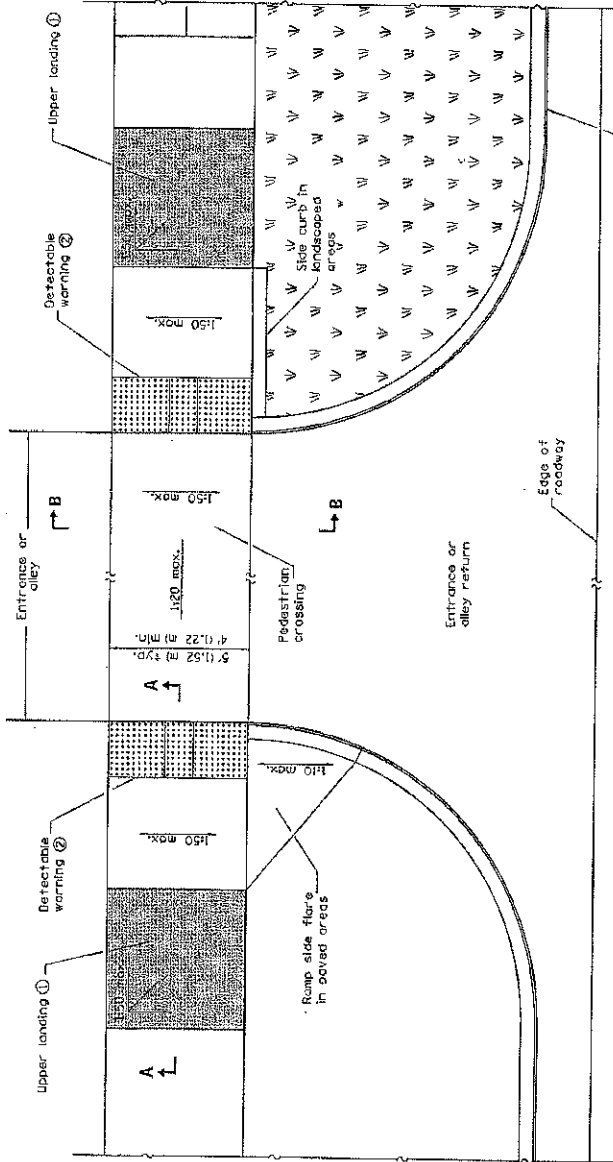

- ② Detectable warning shall only be installed at entrances/alleys with permanent traffic control devices (i.e. stop signs, signals).
- ③ Where possible, maintain the grade of the sidewalk across the entrance/alley to the need for ramps and upper landings.

Sidewalk width: 5' (1.52 m) typical, 4' (1.22 m) min.

ENTRANCE / ALLEY PEDESTRIAN CROSSING

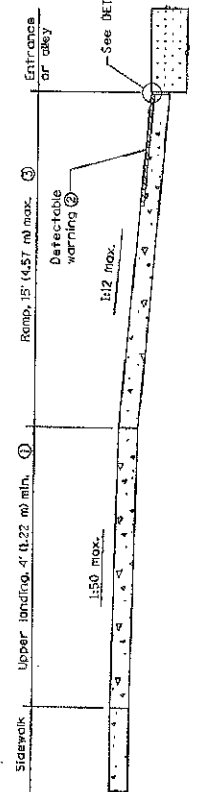

SECTION A-A

① Upper landing not required for ramp slopes flatter than 1:20.

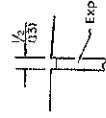

DETAIL A

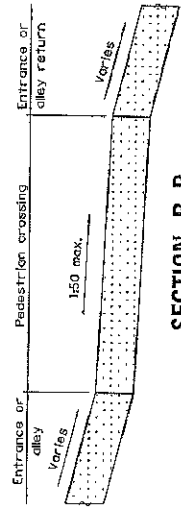

SECTION B-B

Flush with top of roadway curb and top of sidewalk



SIDE CURB DETAIL

GENERAL NOTES

All slope ratios are expressed as units of vertical displacement to units of horizontal displacement (V:H).

All dimensions are in inches (millimeters) unless otherwise shown.

PASSED January 1, 2012 ENGINEER OF POLICY AND PROCEDURES APPROVED ENGINEER OF DESIGN AND ENVIRONMENT	ISSUED	1-1-12
	MINNAPOLIS DEPARTMENT OF TRANSPORTATION 1-1-12	
	STANDARD 424026	

DATE	REVISIONS
1-1-12	New standard.

ENTRANCE / ALLEY PEDESTRIAN CROSSINGS

STANDARD 424026

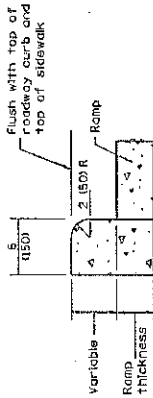

SIDE CURB DETAIL



DETAIL A

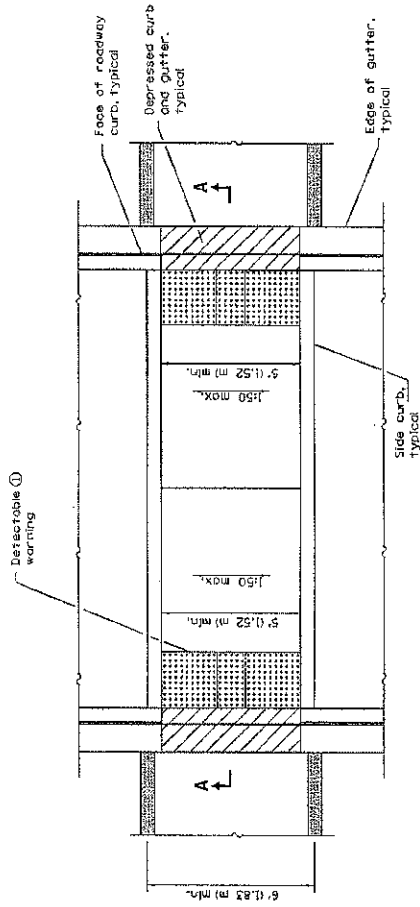

MEDIAN PEDESTRIAN CROSSING

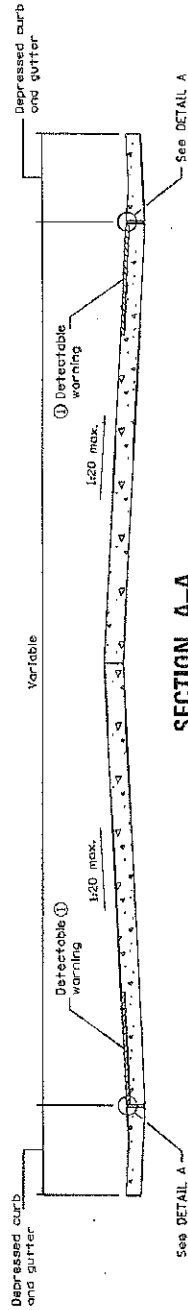

SECTION A-A

① omit detectable warnings when distance between back of curbs is less than 6' 11.83 in.

GENERAL NOTES

All slope ratios are expressed as units of vertical displacement to units of horizontal displacement (1:20).

See Standard 606003 for details of depressed curb adjacent to curb ramp.

All dimensions are in inches (millimeters) unless otherwise shown.

Missouri Department of Transportation	
PASSED	January 1, 2012
APPROVED	Missouri State Engineer
APPROVED	Missouri State Engineer
APPROVED	Missouri State Engineer
APPROVED	Missouri State Engineer
ISSUED	T-1-12

DATE	REVISIONS
1-1-12	New standard.

MEDIAN PEDESTRIAN CROSSINGS

STANDARD 424031

CAMPAIGN DISCLOSURE CERTIFICATE

Any contractor, proposer, bidder or vendor who responds by submitting a bid or proposal to the Village of Downers Grove shall be required to submit with its bid submission, an executed Campaign Disclosure Certificate.

The Campaign Disclosure Certificate is required pursuant to the Village of Downers Grove Council Policy on Ethical Standards and is applicable to those campaign contributions made to any member of the Village Council.

Said Campaign Disclosure Certificate requires any individual or entity bidding to disclose campaign contributions, as defined in Section 9-1.4 of the Election Code (10 ILCS 5/9-1.4), made to current members of the Village Council within the five (5) year period preceding the date of the bid or proposal release.

By signing the bid documents, contractor/proposer/bidder/vendor agrees to refrain from making any campaign contributions as defined in Section 9-1.4 of the Election Code (10 ILCS 5/9-1.4) to any Village Council member and any challengers seeking to serve as a member of the Downers Grove Village Council.

Under penalty of perjury, I declare:

Bidder/vendor has not contributed to any elected Village position within the last five (5) years.

Signature

NICK PALMONDE
Print Name

Bidder/vendor has contributed a campaign contribution to a current member of the Village Council within the last five (5) years.

Print the following information:

Name of Contributor: _____
(company or individual)

To whom contribution was made: _____

Year contribution made: _____ Amount: \$ _____

Signature

Print Name

Account Number	Title	2011 Budget	2011 Actual	2012 YTD Actual	2012 Budget	2013 Projection	2014 Projection
107.30.341.5315.0000	E Professional Services	\$0.00	\$0.00	\$0.00	\$35,000	\$0	\$0
	<i>traffic and transit study</i>				\$35,000		
107.30.341.5670.0000	E Claims & Similar Exps	\$0.00	\$0.00	\$0.00	\$0	\$0	\$0
107.30.341.5740.0000	E Infrastructure	\$0.00	\$0.00	\$0.00	\$0	\$0	\$0
110.30.341.5810.0000	E Land	\$0.00	\$0.00	\$0.00	\$0	\$0	\$0
110.30.341.5840.0000	E Infrastructure	\$0.00	\$0.00	\$0.00	\$500,000	\$500,000	\$730,000
	<i>Ogden Avenue public improvements</i>				\$500,000	\$500,000	\$500,000
220.30.341.5210.0000	E Supplies	\$0.00	\$0.00	\$0.00	\$0	\$0	\$0
220.30.341.5315.0000	E Professional Services	\$0.00	\$0.00	\$0.00	\$0	\$0	\$0
220.30.341.5740.0000	E Infrastructure	\$298,650.00	\$267,427.23	\$0.00	\$182,325	\$191,500	\$451,075
	<i>S-006 REPLACEMENT SIDEWALK PROGRAM</i>				\$182,325	\$191,500	\$201,075
220.30.341.5760.0000	E Improvements Other Than Buildings	\$0.00	\$0.00	\$0.00	\$0	\$0	\$0
220.30.341.5810.0000	E Land	\$300,000.00	\$0.00	\$0.00	\$300,000	\$50,000	\$0
	<i>S-005 OGDEN AV SIDEWALK INSTALLATION/CURB CUT REDUCTION</i>				\$50,000	\$50,000	
	<i>S-005 OGDEN AV SIDEWALK INSTALLATION/CURB CUT REDUCTION - IL JOBS NOW APPROVED GRANT PORTION</i>				\$0		
	<i>S-004 NEW SIDEWALK INSTALLATION PROGRAM</i>				\$250,000		
220.30.341.5840.0000	E Infrastructure	\$265,000.00	\$166,085.05	\$0.00	\$300,000	\$307,500	\$1,059,000
	<i>S-004 NEW SIDEWALK INSTALLATION PROGRAM</i>				\$300,000	\$307,500	\$315,000
220.30.341.5860.0000	E Improvements Other Than Buildings	\$0.00	\$0.00	\$0.00	\$0	\$0	\$0
992.30.341.5840.0000	E Infrastructure	\$0.00	\$0.00	\$0.00	\$0	\$0	\$0