

VILLAGE OF DOWNERS GROVE
REPORT FOR THE VILLAGE COUNCIL MEETING
JUNE 19, 2012 AGENDA

SUBJECT:	TYPE:	SUBMITTED BY:
Amendment and Restatement to License Agreements with Sprintcom, Inc.	✓ Resolution Ordinance Motion Discussion Only	Enza Petrarca Village Attorney

SYNOPSIS

Resolutions have been prepared authorizing approval of a First Amendment and Restatement to License Agreement with Sprintcom, Inc. to maintain and operate antennas on Village Property located at 3301 Finley and 5235 Katrine. A Resolution has been prepared authorizing approval of a Second Amendment and Restatement to License Agreement to maintain and operate an antenna on Village Property located at 4414 Downers Drive.

STRATEGIC PLAN ALIGNMENT

The goals for 2011 to 2018 identified *Steward of Financial and Environmental Sustainability*.

FISCAL IMPACT

The proposed agreements are for an additional two (2) five year terms, which would begin upon the end of the existing license agreements on November 1, 2103. The Village shall collect \$4,000 for the Finley site, \$2,700 for the Katrine site and \$4,500 for the Downers Drive site monthly (with a four percent increase effective January 1 of each year) until December 31, 2023.

RECOMMENDATION

Approval on the June 19, 2012 consent agenda.

BACKGROUND

SprintCom, Inc. is a provider of digital communications in the Chicagoland area. SprintCom contacted the Village concerning its desire to renew these antenna agreements. The amendments provide for the extension of the license agreement, revise the monthly compensation and amend the tax payment and subletting provisions of the existing agreements.

In 1998 (see Resolution 98-38), the Council approved three license agreements with SprintCom for the installation, maintenance and operation of antenna on Village property located at 3301 Finley, and 5235 Katrine and (4318) n/k/a 4414 Downers Drive. These existing agreements are due to expire August 31, 2013. In 2009 (see Resolution 2009-86), the Council approved a first amendment to the license agreement for the 4414 Downers Drive for the addition of Clearwire Communication equipment, thereby creating a sublease provision where the Village receives an additional \$500 per month in rent.

The proposed amendment will add two additional five (5) year terms, commencing upon the end of the current lease (11/1/13) and would conclude on December 31, 2023. Approval of the proposed agreement beginning November 1, 2013 would result in the Village collecting \$2,700 for the Katrine site, \$4,000 for the Finley site and \$4,500 for the Downers Drive site until December 31, 2023, with a four percent increase in each year thereafter. The Village will again have the option of renewing the license agreement for two additional five year terms at the conclusion of the first amendment.

ATTACHMENTS

Resolutions and Agreements
 Resolution 98-58

RESOLUTION NO. _____

**A RESOLUTION AUTHORIZING EXECUTION OF A FIRST AMENDMENT
AND RESTATEMENT TO LICENSE AGREEMENT**

BE IT RESOLVED by the Village Council of the Village of Downers Grove, DuPage County, Illinois as follows:

1. That the form and substance of a certain Agreement (“Agreement”), between the Village of Downers Grove (“Village”) and Sprintcom, Inc. (“Licensee”) for a first amendment to license agreement for the maintenance and operation of antenna equipment on Village property located at 3301 Finley, Downers Grove, IL, as set forth in the Agreement submitted to this meeting with the recommendation of the Village Manager, is hereby approved.

2. That the Village Manager and Village Clerk are hereby respectively authorized and directed for and on behalf of the Village to execute, attest, seal and deliver the Agreement, substantially in the form approved in the foregoing paragraph of this Resolution, together with such changes as the Manager shall deem necessary.

3. That the proper officials, agents and employees of the Village are hereby authorized and directed to take such further action as they may deem necessary or appropriate to perform all obligations and commitments of the Village in accordance with the provisions of the Agreement.

4. That all resolutions or parts of resolutions in conflict with the provision of this Resolution are hereby repealed.

5. That this Resolution shall be in full force and effect from and after its passage as provided by law.

Mayor

Passed:

Attest: _____

Village Clerk

**FIRST AMENDMENT & RESTATEMENT
TO LICENSE AGREEMENT**

THIS FIRST AMENDMENT & RESTATEMENT TO LICENSE AGREEMENT ("First Amendment"), dated as of the later of the signature dates below, is by and between the **VILLAGE OF DOWNERS GROVE**, an Illinois municipal corporation, having a mailing address of 801 Burlington Avenue, Downers Grove, Illinois 60515 (hereinafter referred to as "Village") and **SPRINTCOM, INC.**, a Kansas corporation, having a mailing address of 6391 Sprint Parkway, Overland Park, KS 66251-2650 (hereinafter referred to as "Licensee").

WHEREAS, Village and Licensee entered into a License Agreement entitled "LICENSE AGREEMENT BETWEEN THE VILLAGE OF DOWNERS GROVE AND SPRINTCOM, INC. TO INSTALL, MAINTAIN AND OPERATE ANTENNA EQUIPMENT ON VILLAGE PROPERTY" dated July 6, 1998 (along with Resolution 98-38), copies of which are attached hereto, whereby Village leased to Licensee certain Premises, therein described, that are a portion of the Property located at 3301 Finley Road, Downers Grove, Illinois (the "Agreement"); and

WHEREAS, Village and Licensee desire to amend the Agreement to provide that the term of the Agreement shall be restated, extended and to confirm compensation amounts and tax payment responsibility; and

WHEREAS, Village and Licensee also desire to amend the Agreement to provide that any notice or communication shall be sent to the Village at its current address and to Licensee at its current address.

NOW THEREFORE, in consideration of the foregoing and other good and valuable consideration, the receipt and sufficiency of which are hereby acknowledged, Village and Licensee agree as follows:

1. Section 1. "CONTRACT DOCUMENTS" of the Agreement is stricken and amended as follows:

Section 1. CONTRACT DOCUMENTS. The provisions set forth in the preamble and the following exhibits are incorporated into and made a part of this Agreement:

- a. Exhibit 1 – Site map(s) of the Property (or upgrades thereto), as amended from time to time and approved by the Village, showing the Tower Space and the Ground Space, together with the areas on the Property licensed to Licensee to provide access and utility service to the Ground Space (collectively the "Licensed Premises") which includes location of any proposed underground utilities necessary for operation of the Antenna.
- b. Exhibit 2 – Plans and specifications (or upgrades thereto), as amended from time to time and approved by the Village, for the Antenna and any cables or utility lines

installed on the Licensed Premises and the equipment cabinets to be installed on the License Premises and used for housing of the related Antenna equipment (collectively the "Licensee Improvements").

2. Section 3. "SPECIFICATIONS", the first sentence of paragraph (b) of the Agreement shall be deleted in its entirety.

3. Section 4. "CONSTRUCTION, INSTALLATION AND MAINTENANCE", paragraph (g) of the Agreement is stricken and amended as follows:

g. Licensee shall be entitled to access their equipment Monday through Friday, 7:00am to 3:30pm CST, by contacting the Village Building Services Department at 630/434-5551. If access is required after business hours, on weekends, on a holiday or in the event of an emergency, Licensee shall contact the Village Operations Center at 630/434-5706 or 630/434-5707

4. Section 6. "TERM" of the Agreement is amended to extend the term of the current Agreement. With this First Amendment, the Agreement shall be automatically renewed for two (2) additional, approximately five (5) year renewal terms as follows:

(c) The initial renewal term will commence on September 1, 2013 and shall end December 31, 2013. Thereafter, and as part and parcel of the initial renewal term, one additional five (5) year period shall automatically commence January 1st terminating on December 31, 2018. The second renewal term of this First Amendment shall automatically commence January 1, 2019 and shall end December 31, 2023, the final expiration date. Automatic renewal as provided herein will only cease upon at least one hundred twenty (120) days written notice of non-renewal in advance of the commencement of the second renewal term by one party to the other or until the final expiration date, which ever is sooner. Village agrees not to terminate this Agreement simply as a method to re-negotiate the terms contained herein.

After January 1, 2019, Licensee may request the Village to enter into negotiations toward renewing or extending this Agreement. Any renewal or extension shall be according to terms that are mutually agreeable and the Village shall not be bound to accept any particular terms or to renew any or all of the rights granted by this Agreement.

5. Section 7. "COMPENSATION", the second, third and fourth sentences of the Agreement are stricken and amended as follows:

Beginning on September 1, 2013, Licensee shall pay to the Village a license fee of \$4,000.00 per month each month of 2013. **Thereafter, effective on the first day of January in each subsequent year during the term of the Agreement, the monthly license fee shall increase in an amount equal to the fee for the preceding year multiplied by 4%.** The monthly fee shall be paid to the Village of Downers Grove, Village Hall, 801 Burlington Avenue, Downers Grove, IL 60515 each month by the 10th of the month.

6. Section 12. "TAXES" of the Agreement is stricken and amended as follows:

Section 12. TAXES. Licensee is solely responsible for payment of taxes on the leasehold (PIN # 06-31-200-009). Licensee is solely responsible to determine the taxes owed and to comply with the DuPage County payment procedures. Licensee shall reimburse the Village for any personal or real property taxes which are assessed as a result of Licensee's Improvements and directly attributable to its use of the Property under the terms of this First Amendment to the Agreement. Licensee shall have the right, at its own expense and without expense to the Village, to contest by appropriate proceedings, conducted with due diligence and in good faith, the validity of the amount of taxes or reassessment as applicable to the Licensed Premises or the Licensee Improvements. In the event that the Village becomes aware of any tax delinquency and that delinquency is not cured by the Licensee thirty (30) days from the date the Village sends written notice, the Village shall have the right to remove any of Licensee's equipment and terminate this First Amendment to the Agreement.

7. Section 16. "ASSIGNMENT" of the Agreement is stricken and amended as follows:

Section 16. ASSIGNMENT AND SUBLETTING. This Agreement may not be assigned or transferred without the express written consent of the Village, which shall not be unreasonably withheld, conditioned or delayed. The Village agrees to respond to any such request within thirty (30) days from receipt of the request. Any assignment or transfer without such written consent shall, at the option of the Village, be deemed to be void and of no effect. Provided, however, this Agreement may be assigned or transferred to Licensee's parent or subsidiary, successor legal entity or other affiliate of Licensee without the Village's written consent as long as the Village is given written notice of the assignment or transfer within thirty (30) days thereof.

The Village must approve any sublease to any entity that is not Licensee's parent or subsidiary, successor legal entity or other affiliate of Licensee and the Village shall be entitled to fifty percent (50%) of any such sublease in addition to the license fee as described in Section 7. COMPENSATION, above. Approvals shall not be unreasonably withheld, conditioned or delayed.

8. Section 21. "NOTICES" of the Agreement is amended to indicate the current addresses of each party:

To Village:
Village Manager
Village of Downers Grove
801 Burlington Avenue
Downers Grove, IL 60515
630.434-5500

With Copy to:
Village Attorney
Village of Downers Grove
801 Burlington Avenue
Downers Grove, IL 60515
630.434-5541

To Licensee:
SprintCom, Inc.
Sprint/Nextel Property Services
Site ID: CH03XC629
Mailstop KSOPHT0101-Z2650
6391 Sprint Parkway
Overland Park, KS 66251-2650

With Copy to:
Sprint/Nextel Law Department
Attn: Real Estate Attorney
Site ID: CH03XC29
Mailstop KSOPHT0101-Z2020
6391 Sprint Parkway
Overland Park, KS 66251-2020

9. Except as amended herein, all terms, conditions, provisions, covenants and agreements contained in the Agreement shall be reinstated and shall remain in full force and effect in their entirety. In the event of a conflict between this First Amendment and the Agreement, the First Amendment shall control. Each reference in the Agreement to itself shall be deemed also to refer to this First Amendment.

IN WITNESS WHEREOF, the parties have caused their properly authorized representatives to execute and seal this Agreement on the dates set forth below.

VILLAGE OF DOWNERS GROVE

SPRINTCOM, INC.

By: _____

By: *Nathan Olson*

Name: _____

Name: Nathan Olson

Title: Village Manager

Title: Authorized Representative

Date: _____

Date: 6/11/2012

Attest: _____

April Holden, Village Clerk

Subscribed and sworn to before me this

11th day of JUNE, 2012.

Renet A. Mitchell

Notary Public



EXHIBIT 1

SITE MAP(S)

(see attached)

BLACK & VEATCH
 Building a world of difference.



7400 S. COUNTY LINE RD.
 SUITE 1000, L. 60001
 TEL: (714) 951-1800

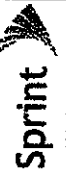

400 S. GRAND AVE.
 EL PASO, TEXAS 79901
 TEL: (817) 313-3000
 FAX: (817) 313-3100



10000 S. UNIVERSITY BLVD.
 SUITE 100
 FORT WORTH, TEXAS 76116
 TEL: (817) 339-3000
 FAX: (817) 339-3100
 CREATON@MCCOMBS.COM

NO.	DATE	BY	CHKD.	DESCRIPTION
1	01/10/01
2	01/10/01
3	01/10/01
4	01/10/01
5	01/10/01
6	01/10/01
7	01/10/01
8	01/10/01
9	01/10/01
10	01/10/01



OWNER
 DOWNERS
 GROVE FINLEY
 UT

PROJECT NO.
 CH03XC629

SITE ADDRESS
 3301 FINLEY ROAD
 DOWNERS GROVE, IL 60515

SHEET NAME
 ENLARGED
 SITE PLAN

SHEET NUMBER
 C-1A

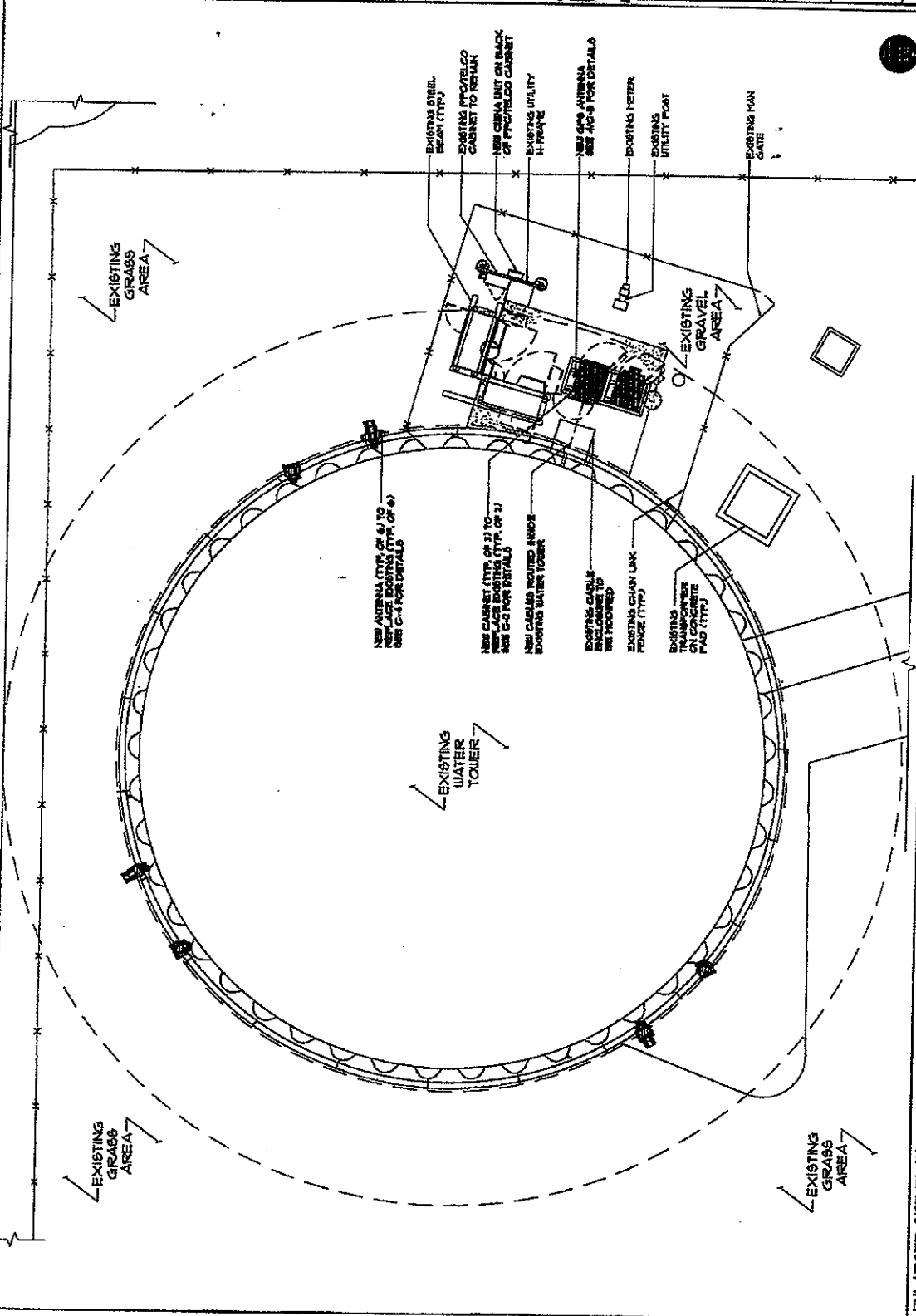

SCALE: 1" = 50'-0"

ENLARGED SITE PLAN

BLACK & VEATCH
Building a world of difference.



Wire & Cable, Inc. Inc.
DART MOBILE, L. 60913
TEL: 636-792-8000

sprint

480 W. GRAND AVE.
PLANNING, ILLINOIS 62202
TEL: 618-350-2600
FAX: 618-350-2600



6889 W. LINDEN AVE.
ROCKFORD, ILLINOIS 61108
TEL: 815-398-2600
FAX: 815-398-2600
www.kellerconcrete.com

NO.	DATE	DESCRIPTION	BY	CHK
1	08/11/08	ISSUED FOR PERMITS	JK	JK
2	08/11/08	REVISED PER COMMENTS	JK	JK
3	08/11/08	REVISED PER COMMENTS	JK	JK
4	08/11/08	REVISED PER COMMENTS	JK	JK
5	08/11/08	REVISED PER COMMENTS	JK	JK



DOINERS6
GROVE FINLEY
ILLINOIS

CH03XC629

1800 FINLEY ROAD
POCAHONTAS GROVE, IL 60913

PLATFORM LAYOUT

C-2

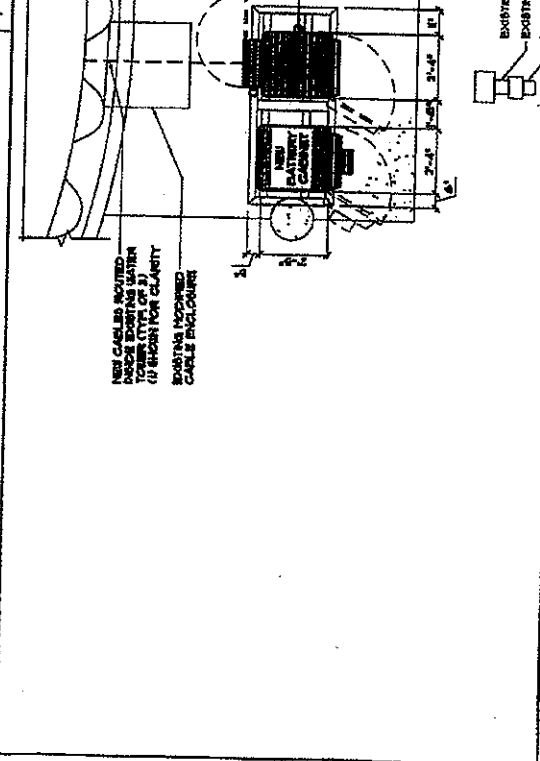
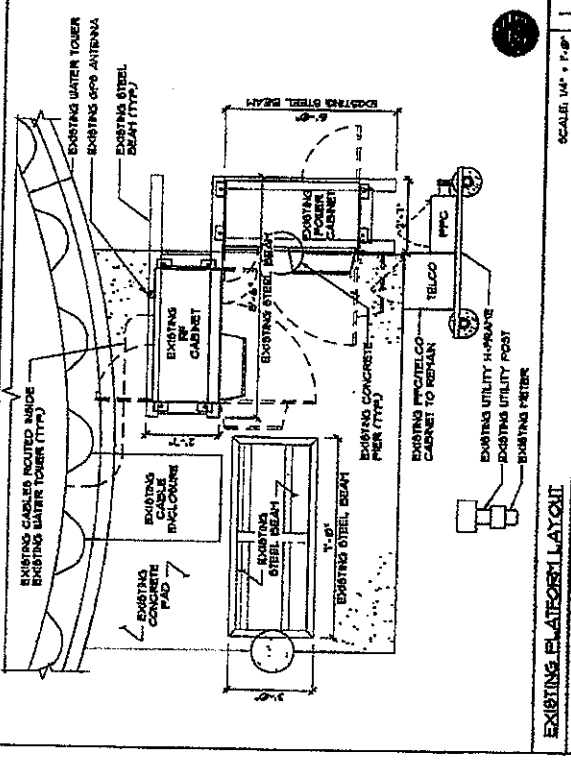
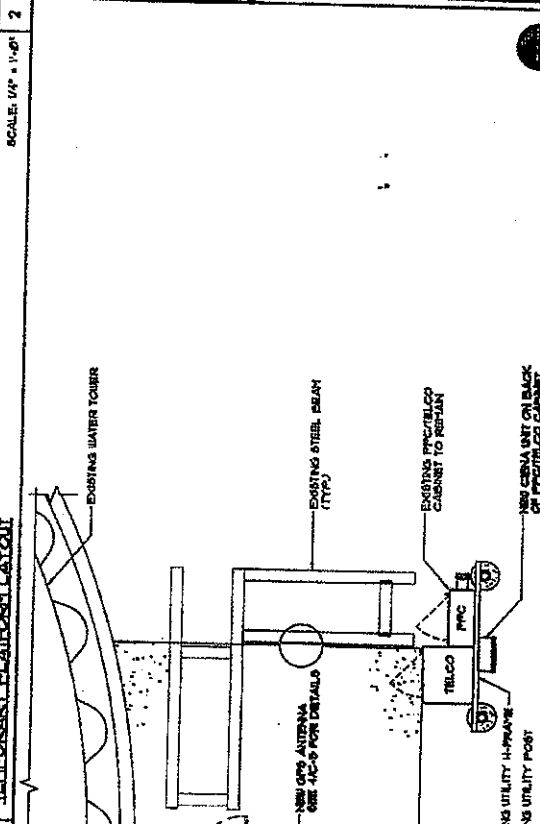
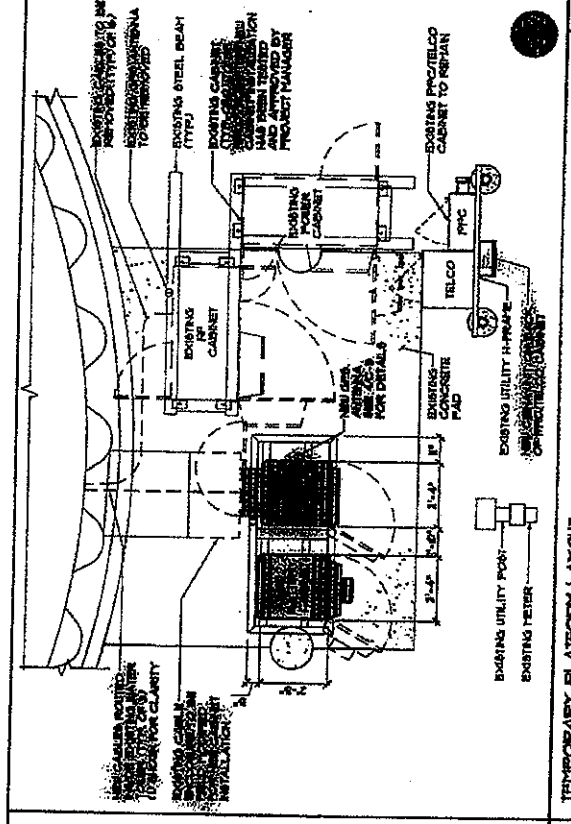

THIS DRAWING IS THE PROPERTY OF FILEMON ENGINEERING CONSULTANTS, INC. IT IS FOR THE EXCLUSIVE USE OF THE PROJECT AND NO OTHER PROJECTS SHOULD BE DRAWN FROM THIS DRAWING WITHOUT THE WRITTEN CONSENT OF FILEMON ENGINEERING CONSULTANTS, INC. NO PART OF THIS DRAWING IS TO BE REPRODUCED OR TRANSMITTED IN ANY FORM OR BY ANY MEANS, ELECTRONIC OR MECHANICAL, INCLUDING PHOTOCOPYING, RECORDING, OR BY ANY INFORMATION STORAGE AND RETRIEVAL SYSTEM.

EXHIBIT 2

PLANS AND SPECIFICATIONS

(see attached)

BLACK & VEATCH
Building a world of differences.



1600 S. COUNTY, LANE RD.
P.O. BOX 1000, L. 60001
TEL: 817-341-1000
FAX: 817-341-1000

Sprint
400 W. GRAND AVE.
SUITE 200
DALLAS, TX 75201
TEL: (214) 373-2200
FAX: (214) 373-2200

AT&T
1600 S. COUNTY, LANE RD.
SUITE 200
DALLAS, TX 75201
TEL: (214) 373-2200
FAX: (214) 373-2200

NO.	DATE	DESCRIPTION	BY	CHKD
1	11/11/03	ISSUED FOR PERMITTING	WV	WV
2	11/11/03	ISSUED FOR PERMITTING	WV	WV
3	11/11/03	ISSUED FOR PERMITTING	WV	WV
4	11/11/03	ISSUED FOR PERMITTING	WV	WV
5	11/11/03	ISSUED FOR PERMITTING	WV	WV
6	11/11/03	ISSUED FOR PERMITTING	WV	WV
7	11/11/03	ISSUED FOR PERMITTING	WV	WV
8	11/11/03	ISSUED FOR PERMITTING	WV	WV
9	11/11/03	ISSUED FOR PERMITTING	WV	WV
10	11/11/03	ISSUED FOR PERMITTING	WV	WV



SITE NAME
DOWNERS GROVE FINLEY

SITE NO.
CH09XC629

SITE ADDRESS
**3801 FINLEY ROAD
DOWNERS GROVE, L. 60018**

SHEET NAME
**SECTOR 2
ANTENNA
LAYOUT**

SHEET NUMBER
C-4B

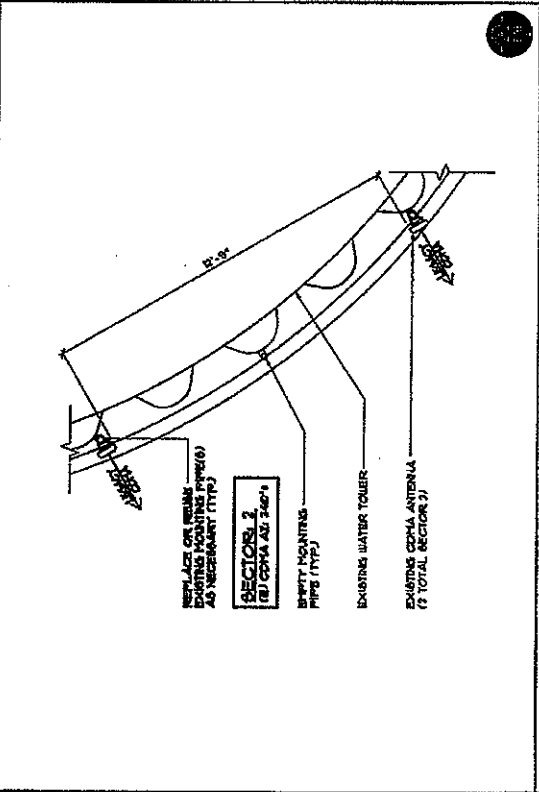
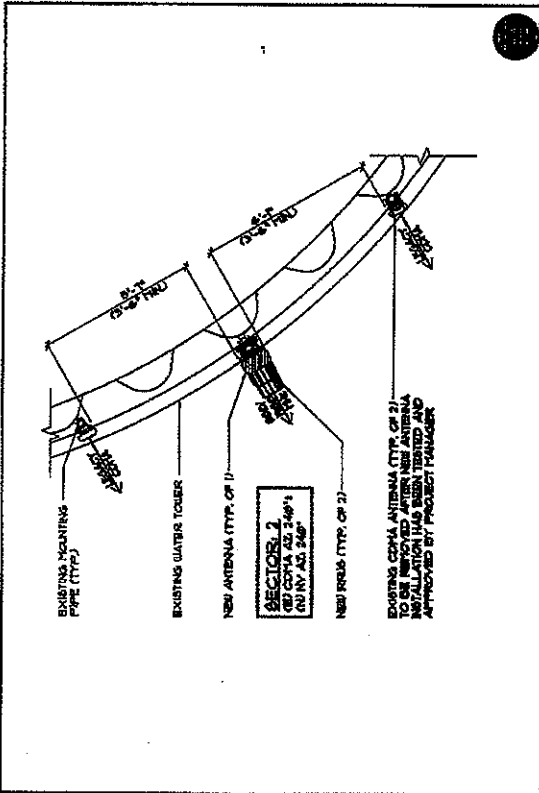

SCALE: 1/4" = 1'-0" 1 **TEMPORARY SECTOR 2 ANTENNA LAYOUT** 2

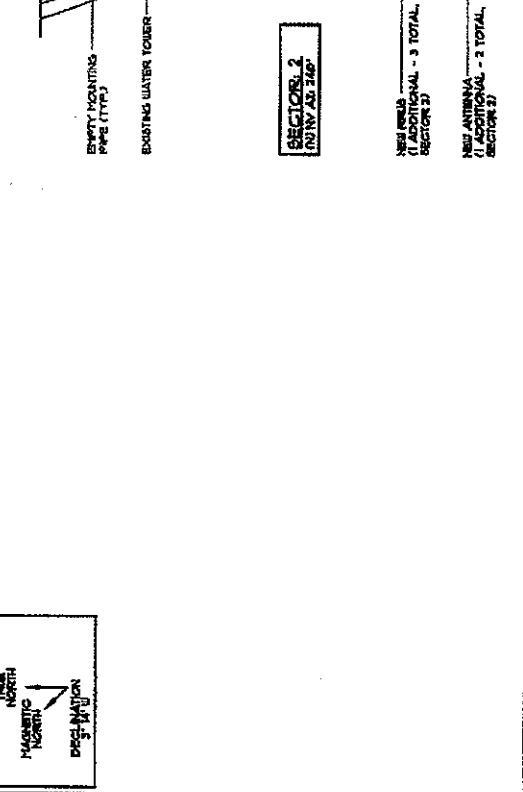
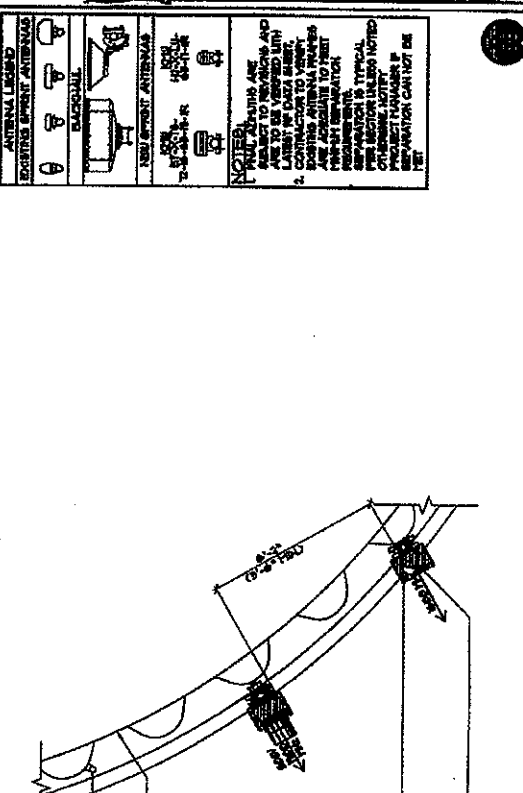

SCALE: 1/4" = 1'-0" 1 **EXISTING SECTOR 2 ANTENNA LAYOUT**

SCALE: 1/4" = 1'-0" 3 **FINAL SECTOR 2 ANTENNA LAYOUT**

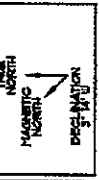

TRUE NORTH
MAGNETIC NORTH
DECREASING

- ANTENNA LEGEND
- EXISTING SPRINT ANTENNAS
- EXISTING AT&T ANTENNAS
- NEW SPRINT ANTENNAS
- NEW AT&T ANTENNAS
- NEW FEEDS
- NEW ANTENNAS

NOTES:
1. ALL ANTENNAS ARE SUBJECT TO INTERFERENCE AND ARE TO BE VERIFIED WITH LATEST DE DATA SHEET.
2. EXISTING ANTENNA FEEDS ARE APPROPRIATE TO FEED PERMIT INFORMATION.
3. SEPARATION & TYPICAL PER SECTOR IS 1500' NOTED ON SHEET C-4A.
4. ALL ANTENNAS ARE TO BE SEPARATED AS NOTED ON SHEET C-4A.
5. SEPARATION CANNOT BE MET.

THIS DRAWING IS THE PROPERTY OF BLACK & VEATCH ENGINEERS CONSULTANTS, P.C. IT IS NOT TO BE REPRODUCED OR TRANSMITTED IN ANY FORM OR BY ANY MEANS, ELECTRONIC OR MECHANICAL, WITHOUT THE WRITTEN PERMISSION OF BLACK & VEATCH ENGINEERS CONSULTANTS, P.C.

BLACK & VEATCH
Building a world of difference.



1400 S COUNTY LINE RD
DURANT, MISSISSIPPI 39067
TEL: 601-795-1600

Sprint
4000 W GRAND AVE
BIRMINGHAM, ALABAMA 35202
TEL: 205-988-6000
FAX: (205) 276-9700

AT&T
1600 W. SOUTH LAKE AVENUE
ROCKFORD, ILLINOIS 60086
TEL: 815-398-0000
FAX: 815-398-0000
PROJ: 01011001
ISSUE: 01011001

APPROVED BY:	DATE:
DESIGNED BY:	DATE:
CHECKED BY:	DATE:
DRAWN BY:	DATE:
SCALE:	DATE:
REVISION:	DATE:
NO.	DATE:
BY:	DATE:
DATE:	



SITE NAME:
**DOINERS FINLEY
GROVE FINLEY
UT**

SITE NO:
CH03XC629

SITE ADDRESS:
**3361 FINLEY ROAD
DOINERS GROVE, IL 60989**

SHEET NAME:
**ANTENNA
DETAILS**

SHEET NUMBER:
C-6

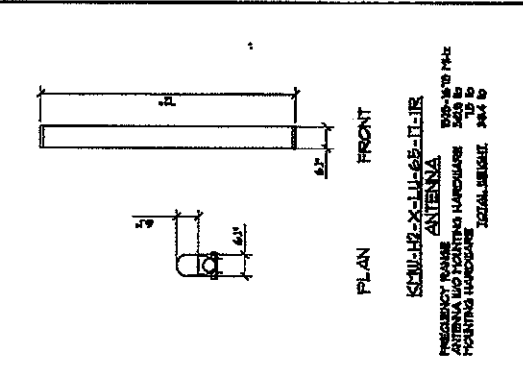

FRONT
PLAN
**SMU-H2-X-11-02-11-R
ANTENNA**
FREQUENCY RANGE: 800-1900 MHz
ANTENNA W/O MOUNTING HARDWARE: 23.5 lb
MOUNTING HARDWARE: 22.0 lb
TOTAL WEIGHT: 45.5 lb

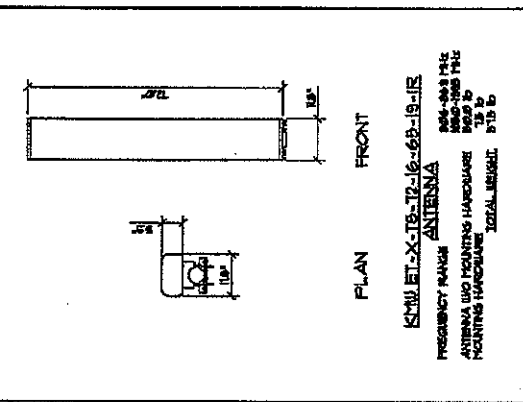

FRONT
PLAN
**KMU-ET-X-19-12-10-09-19-R
ANTENNA**
FREQUENCY RANGE: 800-1900 MHz
ANTENNA W/O MOUNTING HARDWARE: 18.0 lb
MOUNTING HARDWARE: 5.5 lb
TOTAL WEIGHT: 23.5 lb

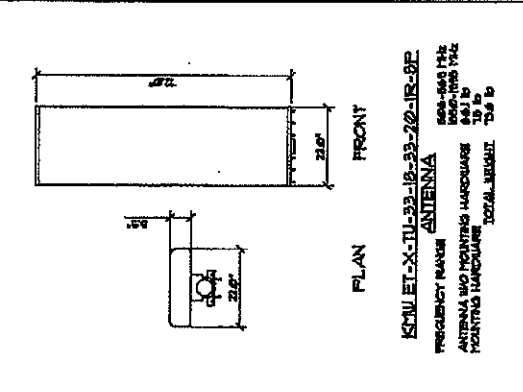

FRONT
PLAN
**KMU-ET-X-11-33-10-33-20-19-R
ANTENNA**
FREQUENCY RANGE: 800-1900 MHz
ANTENNA W/O MOUNTING HARDWARE: 24.0 lb
MOUNTING HARDWARE: 5.0 lb
TOTAL WEIGHT: 29.0 lb

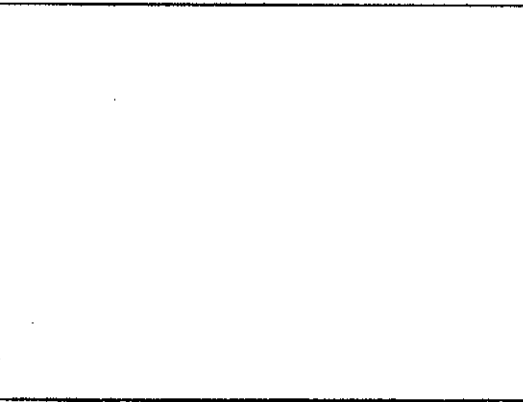

FRONT
PLAN
**KMU-ET-X-11-33-10-33-20-19-R
ANTENNA**
FREQUENCY RANGE: 800-1900 MHz
ANTENNA W/O MOUNTING HARDWARE: 24.0 lb
MOUNTING HARDWARE: 5.0 lb
TOTAL WEIGHT: 29.0 lb

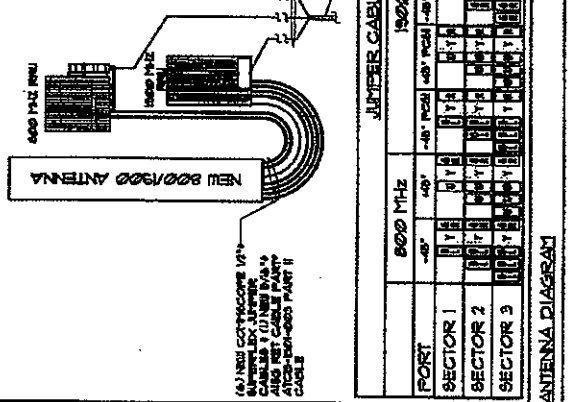
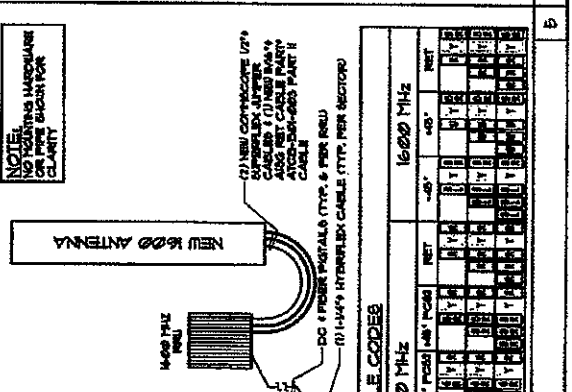
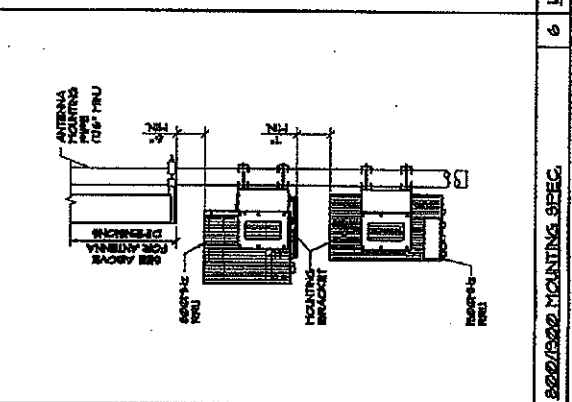
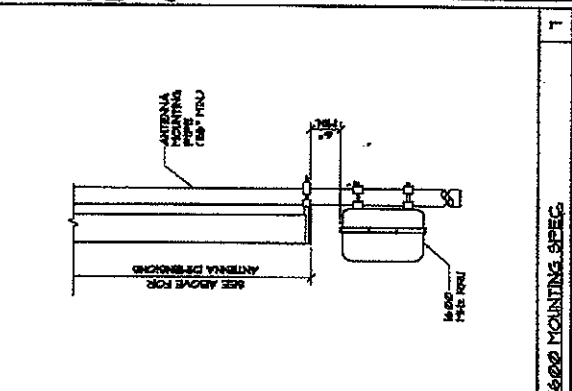

JUMPER CABLE CODES

PORT	800 MHz	1900 MHz	1600 MHz
SECTOR 1	1600 MHz	1900 MHz	800 MHz
SECTOR 2	1600 MHz	1900 MHz	800 MHz
SECTOR 3	1600 MHz	1900 MHz	800 MHz

NOT USED

1 800/1900 ANTENNA SPEC. SECTOR 1
2 800/1900 ANTENNA SPEC. SECTOR 2,3
3 800/1900 ANTENNA SPEC. SECTOR 2,3
4 1600 ANTENNA SPEC.

ANTENNA DIAGRAM

6 800/1900 MOUNTING SPEC.
7 1600 MOUNTING SPEC.

RESOLUTION NO. _____

**A RESOLUTION AUTHORIZING EXECUTION OF A FIRST AMENDMENT
AND RESTATEMENT TO LICENSE AGREEMENT**

BE IT RESOLVED by the Village Council of the Village of Downers Grove, DuPage County, Illinois as follows:

1. That the form and substance of a certain Agreement (“Agreement”), between the between the Village of Downers Grove (“Village”) and Sprintcom, Inc. (“Licensee”) for a first amendment to license agreement for the maintenance and operation of antenna equipment on Village property located at 5235 Katrine, Downers Grove, IL, as set forth in the Agreement submitted to this meeting with the recommendation of the Village Manager, is hereby approved.

2. That the Village Manager and Village Clerk are hereby respectively authorized and directed for and on behalf of the Village to execute, attest, seal and deliver the Agreement, substantially in the form approved in the foregoing paragraph of this Resolution, together with such changes as the Manager shall deem necessary.

3. That the proper officials, agents and employees of the Village are hereby authorized and directed to take such further action as they may deem necessary or appropriate to perform all obligations and commitments of the Village in accordance with the provisions of the Agreement.

4. That all resolutions or parts of resolutions in conflict with the provision of this Resolution are hereby repealed.

5. That this Resolution shall be in full force and effect from and after its passage as provided by law.

Mayor

Passed:

Attest: _____

Village Clerk

**FIRST AMENDMENT & RESTATEMENT
TO LICENSE AGREEMENT**

THIS FIRST AMENDMENT & RESTATEMENT TO LICENSE AGREEMENT (“First Amendment”), dated as of the later of the signature dates below, is by and between the **VILLAGE OF DOWNERS GROVE**, an Illinois municipal corporation, having a mailing address of 801 Burlington Avenue, Downers Grove, Illinois 60515 (hereinafter referred to as “Village”) and **SPRINTCOM, INC.**, a Kansas corporation, having a mailing address of 6391 Sprint Parkway, Overland Park, KS 66251-2650 (hereinafter referred to as “Licensee”).

WHEREAS, Village and Licensee entered into a License Agreement entitled “LICENSE AGREEMENT BETWEEN THE VILLAGE OF DOWNERS GROVE AND SPRINTCOM, INC. TO INSTALL, MAINTAIN AND OPERATE ANTENNA EQUIPMENT ON VILLAGE PROPERTY” dated July 6, 1998 (along with Resolution 98-38), copies of which are attached hereto, whereby Village leased to Licensee certain Premises, therein described, that are a portion of the Property located at 5235 Katrine Avenue, Downers Grove, Illinois (the “Agreement”); and

WHEREAS, Village and Licensee desire to amend the Agreement to provide that the term of the Agreement shall be restated, extended and to confirm compensation amounts and tax payment responsibility; and

WHEREAS, Village and Licensee also desire to amend the Agreement to provide that any notice or communication shall be sent to the Village at its current address and to Licensee at its current address.

NOW THEREFORE, in consideration of the foregoing and other good and valuable consideration, the receipt and sufficiency of which are hereby acknowledged, Village and Licensee agree as follows:

1. Section 1. “CONTRACT DOCUMENTS” of the Agreement is stricken and amended as follows:

Section 1. CONTRACT DOCUMENTS. The provisions set forth in the preamble and the following exhibits are incorporated into and made a part of this Agreement:

- a. Exhibit 1 – Site map(s) of the Property (or upgrades thereto), as amended from time to time and approved by the Village, showing the Tower Space and the Ground Space, together with the areas on the Property licensed to Licensee to provide access and utility service to the Ground Space (collectively the “Licensed Premises”) which includes location of any proposed underground utilities necessary for operation of the Antenna.

- b. Exhibit 2 – Plans and specifications (or upgrades thereto), as amended from time to time and approved by the Village, for the Antenna and any cables or utility lines installed on the Licensed Premises and the equipment cabinets to be installed on the License Premises and used for housing of the related Antenna equipment (collectively, the “Licensee Improvements”).

2. Section 3. “CONSTRUCTION, INSTALLATION AND MAINTENANCE”, paragraph (f) of the Agreement is stricken and amended as follows:

- f. Licensee shall be entitled to access their equipment Monday through Friday, 7:00am to 3:30pm CST, by contacting the Village Building Services Department at 630/434-5551. If access is required after business hours, on weekends, on a holiday or in the event of an emergency, Licensee shall contact the Village Operations Center at 630/434-5706 or 630/434-5707

3. Section 5. “TERM” of the Agreement is amended to extend the term of the current Agreement. With this First Amendment, the Agreement shall be automatically renewed for two (2) additional, approximately five (5) year renewal terms as follows:

(c) The initial renewal term will commence on September 1, 2013 and shall end December 31, 2013. Thereafter, and as part and parcel of the initial renewal term, one additional five (5) year period shall automatically commence January 1st terminating on December 31, 2018. The second renewal term of this First Amendment shall automatically commence January 1, 2019 and shall end December 31, 2023, the final expiration date. Automatic renewal as provided herein will only cease upon at least one hundred twenty (120) days written notice of non-renewal in advance of the commencement of the second renewal term by one party to the other or until the final expiration date, which ever is sooner. Village agrees not to terminate this Agreement simply as a method to re-negotiate the terms contained herein.

After January 1, 2019, Licensee may request the Village to enter into negotiations toward renewing or extending this Agreement. Any renewal or extension shall be according to terms that are mutually agreeable and the Village shall not be bound to accept any particular terms or to renew any or all of the rights granted by this Agreement.

4. Section 6. “COMPENSATION”, the second, third and forth sentences of the Agreement are stricken and amended as follows:

Beginning on September 1, 2013, Licensee shall pay to the Village a license fee of \$2,700.00 per month each month of 2013. **Thereafter, effective on the first day of January in each subsequent year during the term of the Agreement, the monthly license fee shall increase in an amount equal to the fee for the preceding year multiplied by 4%.** The monthly fee shall be paid to the Village of Downers Grove, Village Hall, 801 Burlington Avenue, Downers Grove, IL 60515 each month by the 10th of the month.

5. Section 10. "TAXES" of the Agreement is stricken and amended as follows:

Section 10. TAXES. Licensee is solely responsible for payment of taxes on the leasehold (PIN # 08-12-302-003). Licensee is solely responsible to determine the taxes owed and to comply with the DuPage County payment procedures. Licensee shall reimburse the Village for any personal or real property taxes which are assessed as a result of Licensee's Improvements and directly attributable to its use of the Property under the terms of this First Amendment to the Agreement. Licensee shall have the right, at its own expense and without expense to the Village, to contest by appropriate proceedings, conducted with due diligence and in good faith, the validity of the amount of taxes or reassessment as applicable to the Licensed Premises or the Licensee Improvements. In the event that the Village becomes aware of any tax delinquency and that delinquency is not cured by the Licensee thirty (30) days from the date the Village sends written notice, the Village shall have the right to remove any of Licensee's equipment and terminate this First Amendment to the Agreement.

6. Section 14. "ASSIGNMENT" of the Agreement is stricken and amended as follows:

Section 14. ASSIGNMENT AND SUBLETTING. This Agreement may not be assigned or transferred without the express written consent of the Village, which shall not be unreasonably withheld, conditioned or delayed. The Village agrees to respond to any such request within thirty (30) days from receipt of the request. Any assignment or transfer without such written consent shall, at the option of the Village, be deemed to be void and of no effect. Provided, however, this Agreement may be assigned or transferred to Licensee's parent or subsidiary, successor legal entity or other affiliate of Licensee without the Village's written consent as long as the Village is given written notice of the assignment or transfer within thirty (30) days thereof.

The Village must approve any sublease to any entity that is not Licensee's parent or subsidiary, successor legal entity or other affiliate of Licensee and the Village shall be entitled to fifty percent (50%) of any such sublease in addition to the license fee as described in Section 6. COMPENSATION, above. Approvals shall not be unreasonably withheld, conditioned or delayed.

7. Section 19. "NOTICES" of the Agreement is amended to indicate the current addresses of each party:

To Village:
Village Manager
Village of Downers Grove
801 Burlington Avenue
Downers Grove, IL 60515
630.434-5500

With Copy to:
Village Attorney
Village of Downers Grove
801 Burlington Avenue
Downers Grove, IL 60515
630.434-5541

To Licensee:
SprintCom, Inc.
Sprint/Nextel Property Services
Site ID: CH03XC638
Mailstop KSOPHT0101-Z2650
6391 Sprint Parkway
Overland Park, KS 66251-2650

With Copy to:
Sprint/Nextel Law Department
Attn: Real Estate Attorney
Site ID: CH03XC38
Mailstop KSOPHT0101-Z2020
6391 Sprint Parkway
Overland Park, KS 66251-2020

8. Except as amended herein, all terms, conditions, provisions, covenants and agreements contained in the Agreement shall be reinstated and shall remain in full force and effect in their entirety. In the event of a conflict between this First Amendment and the Agreement, the First Amendment shall control. Each reference in the Agreement to itself shall be deemed also to refer to this First Amendment.

IN WITNESS WHEREOF, the parties have caused their properly authorized representatives to execute and seal this Agreement on the dates set forth below.

VILLAGE OF DOWNERS GROVE

SPRINTCOM, INC.

By: _____

By: *Nathan Olson*

Name: _____

Name: Nathan Olson

Title: Village Manager

Title: Authorized Representative

Date: _____

Date: 6/5/2012

Attest: _____

April Holden, Village Clerk

Subscribed and sworn to before me this

5th day of JUNE, 2012.

Renet A. Mitchell

Notary Public



EXHIBIT 1

SITE MAP(S)

(see attached)

CH03XC638 KATRINE AVENUE

5231 KATRINE AVE
DOWNERS GROVE, IL 60515

SITE TYPE
COLOCATION

STRUCTURE HEIGHT: 153'-0" H
STRUCTURE TYPE: MONOPOLE
ANTENNA QTY: 8
ANTENNA HEIGHT (CL): 82 FT.
LEASE AREA: N/A
EQUIPMENT MOUNTING: STEEL PLATFORM

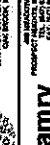
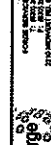
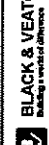

FORSE PROJECT NO. 0000
DRAWN BY: AV
CHECKED BY: FB

DATE: 08/15/08
PROJECT: CH03XC638

CONTRACT: 08-15-302-003
MARKED FOR CONSTRUCTION

DATE: 08/15/08
PROJECT: CH03XC638

DATE: 08/15/08
PROJECT: CH03XC638

DATE: 08/15/08
PROJECT: CH03XC638

DATE: 08/15/08
PROJECT: CH03XC638

DATE: 08/15/08
PROJECT: CH03XC638

DATE: 08/15/08
PROJECT: CH03XC638

DATE: 08/15/08
PROJECT: CH03XC638

DATE: 08/15/08
PROJECT: CH03XC638

DATE: 08/15/08
PROJECT: CH03XC638

DATE: 08/15/08
PROJECT: CH03XC638

DATE: 08/15/08
PROJECT: CH03XC638

DATE: 08/15/08
PROJECT: CH03XC638

DATE: 08/15/08
PROJECT: CH03XC638

DATE: 08/15/08
PROJECT: CH03XC638

DATE: 08/15/08
PROJECT: CH03XC638

DATE: 08/15/08
PROJECT: CH03XC638

DATE: 08/15/08
PROJECT: CH03XC638

DATE: 08/15/08
PROJECT: CH03XC638

DATE: 08/15/08
PROJECT: CH03XC638

DATE: 08/15/08
PROJECT: CH03XC638

DATE: 08/15/08
PROJECT: CH03XC638

DATE: 08/15/08
PROJECT: CH03XC638

DATE: 08/15/08
PROJECT: CH03XC638

DATE: 08/15/08
PROJECT: CH03XC638

DATE: 08/15/08
PROJECT: CH03XC638

DATE: 08/15/08
PROJECT: CH03XC638

DATE: 08/15/08
PROJECT: CH03XC638

DATE: 08/15/08
PROJECT: CH03XC638

DATE: 08/15/08
PROJECT: CH03XC638

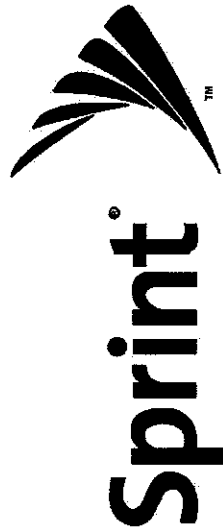

Together with NEXTEL

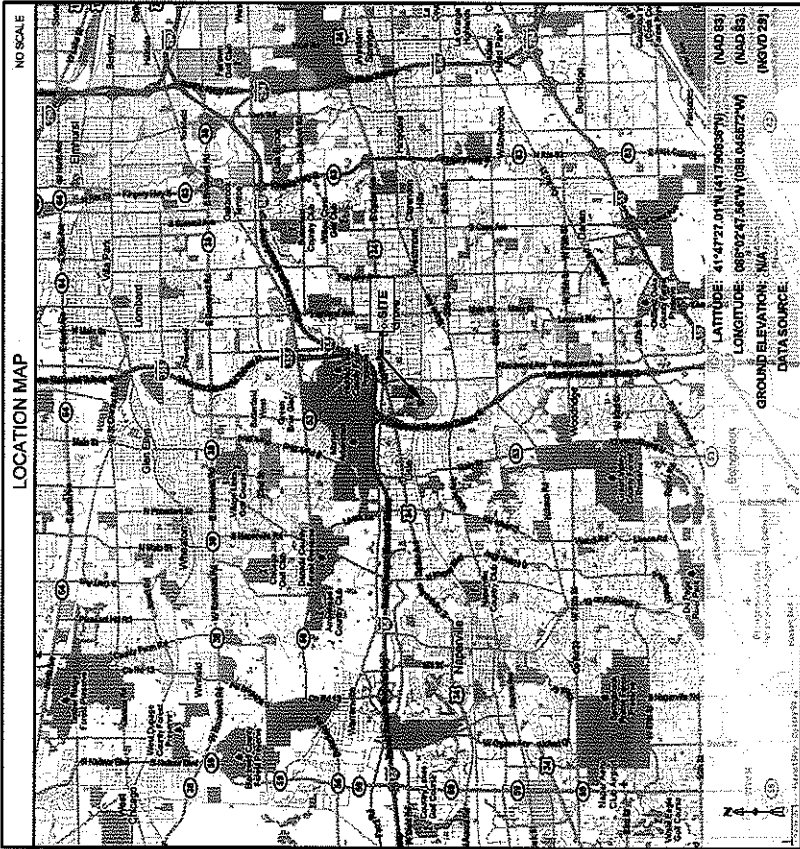

NO.	SHEET NO.	SHEET TITLE	DRAWING INDEX	TOTAL PAGES: 22	REVISIONS
1	1	TITLE SHEET			
2	2	SITE PLAN			
3	3	EQUIPMENT PLAN			
4	4	NORTH ELEVATION			
5	5	SOUTH ELEVATION			
6	6	EQUIPMENT DETAILS			
7	7	GENERAL NOTES			
8	8	GENERAL NOTES			
9	9	GENERAL NOTES			
10	10	GENERAL NOTES			
11	11	GENERAL NOTES			
12	12	GENERAL NOTES			
13	13	GENERAL NOTES			
14	14	GENERAL NOTES			
15	15	GENERAL NOTES			
16	16	GENERAL NOTES			
17	17	GENERAL NOTES			
18	18	GENERAL NOTES			
19	19	GENERAL NOTES			
20	20	GENERAL NOTES			
21	21	GENERAL NOTES			
22	22	GENERAL NOTES			

DRIVING DIRECTIONS

RONALD REAGAN MEMORIAL TOLLWAY, HILLSIDE, IL 60132

1. 2.0 MI. - ABOUT 1.8 MINS
1. HEAD WEST ON I-55 W
PARTIAL TOLL ROAD 7.5 MI
2. TAKE THE EXIT ON I-55 S TOWARD JOLIET
3. TAKE THE MAPLE AVE EXIT
PARTIAL TOLL ROAD 0.5 MI
4. TURN LEFT ONTO MAPLE AVE 0.2 MI
5. TURN LEFT ONTO WANDU AV 0.3 MI
6. TAKE THE 1ST RIGHT ONTO WISCONSIN AVE 0.2 MI
DESTINATION WILL BE ON THE RIGHT 400 FT
5235 KATRINE AVE, DOWNERS GROVE, IL 60515

SITE INFORMATION

PROPERTY OWNER: AMERICAN TOWER, 1000 W. WASHINGTON ST, STE 100, SCHLAUBURG, IL 60174

OWNER CONTACT: ERN S RUMLEY, COO, MANAGER - MIDWEST, (708) 298-4533

SITE ADDRESS: 5231 KATRINE AVE, DOWNERS GROVE, IL 60515

APPLICANT: SPRINTCOM, INC., 400 W GRAND AVE, ELMURST, IL 60120

PROJECT CONTACT: CHRIS SZAFONI, M, (630) 272-5564, T, (630) 586-5560

COUNTY: DU PAGE, PIN: 08-15-302-003

ZONING CLASS: M-1
ZONING JURISDICTION: DOWNERS GROVE
REAL ESTATE REP.: N/A

LATITUDE: 41°47'27.01"N (417908394) (NAD 83)
LONGITUDE: 089°02'47.56"W (08904657240) (NAD 83)
GROUND ELEVATION: N/A
DATA SOURCE: N/A

PROJECT TEAM

FORSE SERVICES, INC., TEL: 630 364-6445
2210 MIDWEST RD, STE 213, FAX: 630 326-0718
OAK BROOK, IL 60020, WWW.FORSE-IL.COM

KAMRY, INC., TEL: (647) 672-7413
408 MEADOW RIDGE, FAX: (647) 656-3668
PROSPECT HEIGHTS, IL 60070, WWW.KAMRYENG.COM

Call before you dig.

ILLINOIS ONE-CALL SYSTEM
CALL BEFORE YOU DIG
THIS NOTICE MUST BE AT LEAST 72 HOURS BEFORE THE START OF EXCAVATION

T1.1

Sprint
Site: 5235 Katrine
Site No: CHO3XC638

EXHIBIT 2

PLANS AND SPECIFICATIONS

(see attached)

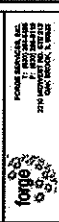
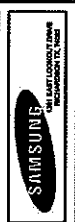

FORGE PROJECT NO.	0000
DRAWN BY	AW
CHECKED BY	FB
DATE	
REVISIONS	
A. REVISION	ISSUED FOR REVIEW
B. REVISION	ISSUED FOR REVIEW
C. REVISION	ISSUED FOR REVIEW
D. REVISION	ISSUED FOR REVIEW
E. REVISION	ISSUED FOR REVIEW

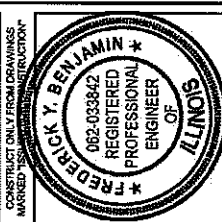

DATE SIGNED: _____
 EXP: _____

CH03XC68
 KATRINE AVENUE
 5231 KATRINE AVE
 DOWNERS GROVE, IL 60515
 COLOCATION

EQUIPMENT PLAN

C1.3

NOTE: CONTRACTOR TO VERIFY ALL ELEC. D.I. DIMENSIONS, MATERIALS, AND BUILDING CONDITIONS FOR CONFORMITY TO THESE DRAWINGS BEFORE ORDERING MATERIAL OR FABRICATING ANY ASSEMBLIES

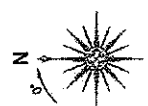
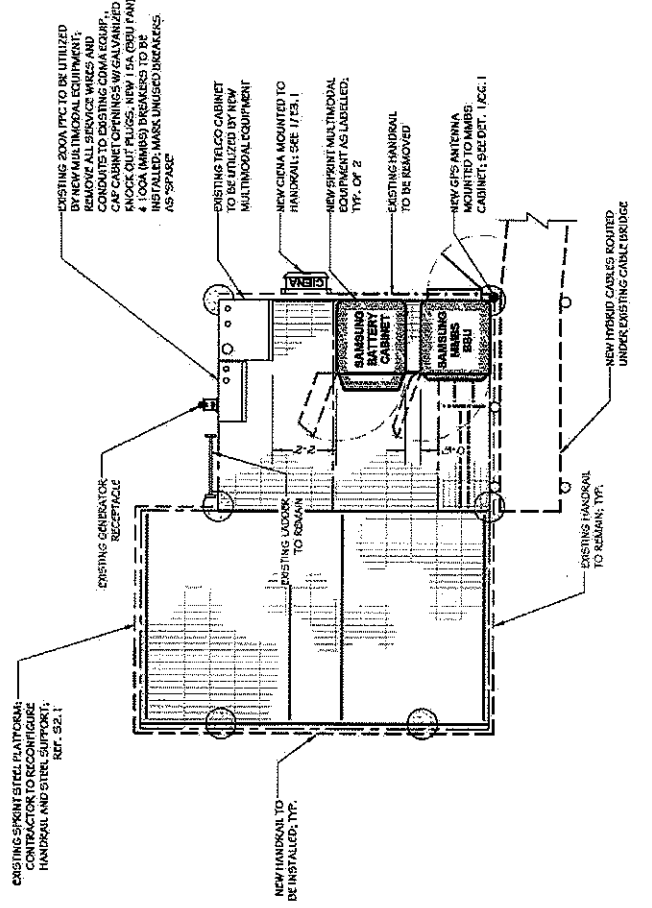

RESOLUTION NO. _____

**A RESOLUTION AUTHORIZING EXECUTION OF A SECOND AMENDMENT
AND RESTATEMENT TO LICENSE AGREEMENT**

BE IT RESOLVED by the Village Council of the Village of Downers Grove, DuPage County, Illinois as follows:

1. That the form and substance of a certain Agreement (“Agreement”), between the Village of Downers Grove (“Village”) and Sprintcom, Inc. (“Licensee”) for a first amendment to license agreement for the maintenance and operation of antenna equipment on Village property located at 4414 Downers Drive, Downers Grove, IL, as set forth in the Agreement submitted to this meeting with the recommendation of the Village Manager, is hereby approved.

2. That the Village Manager and Village Clerk are hereby respectively authorized and directed for and on behalf of the Village to execute, attest, seal and deliver the Agreement, substantially in the form approved in the foregoing paragraph of this Resolution, together with such changes as the Manager shall deem necessary.

3. That the proper officials, agents and employees of the Village are hereby authorized and directed to take such further action as they may deem necessary or appropriate to perform all obligations and commitments of the Village in accordance with the provisions of the Agreement.

4. That all resolutions or parts of resolutions in conflict with the provision of this Resolution are hereby repealed.

5. That this Resolution shall be in full force and effect from and after its passage as provided by law.

Mayor

Passed:

Attest: _____

Village Clerk

**SECOND AMENDMENT & RESTATEMENT
TO LICENSE AGREEMENT**

THIS SECOND AMENDMENT & RESTATEMENT TO LICENSE AGREEMENT ("Second Amendment"), dated as of the later of the signature dates below, is by and between the **VILLAGE OF DOWNERS GROVE**, an Illinois municipal corporation, having a mailing address of 801 Burlington Avenue, Downers Grove, Illinois 60515 (hereinafter referred to as "Village") and **SPRINTCOM, INC.**, a Kansas corporation, having a mailing address of 6391 Sprint Parkway, Overland Park, KS 66251-2650 (hereinafter referred to as "Licensee").

WHEREAS, Village and Licensee entered into a License Agreement entitled "LICENSE AGREEMENT BETWEEN THE VILLAGE OF DOWNERS GROVE AND SPRINTCOM, INC. TO INSTALL, MAINTAIN AND OPERATE ANTENNA EQUIPMENT ON VILLAGE PROPERTY" dated July 6, 1998 (along with Resolution 98-38), and "A RESOLUTION AUTHORIZING EXECUTION OF A AMENDMENT NO. 1 TO LICENSE AGREEMENT BETWEEN THE VILLAGE OF DOWNERS GROVE AND SPRINTCOM, INC. TO INSTALL, MAINTAIN AND OPERATE ANTENNA EQUIPMENT ON VILLAGE PROPERTY", dated September 16, 2009 (along with Resolution 2009-86) copies of which are attached hereto, whereby Village leased to Licensee certain Premises, therein described, that are a portion of the Property located at 4318 Downers Drive, Downers Grove, Illinois (collectively, the "Agreement"); and

WHEREAS, Village and Licensee desire to amend the Agreement and the subsequent amendment thereto to provide that the term of the Agreement shall be restated, extended and to confirm compensation amounts and tax payment responsibility; and

WHEREAS, Village and Licensee also desire to amend the Agreement and the subsequent amendment thereto to provide that any notice or communication shall be sent to the Village at its current address and to Licensee at its current address.

NOW THEREFORE, in consideration of the foregoing and other good and valuable consideration, the receipt and sufficiency of which are hereby acknowledged, Village and Licensee agree as follows:

1. Section 1. "CONTRACT DOCUMENTS" of the Agreement is stricken and amended as follows:

Section 1. CONTRACT DOCUMENTS. The provisions set forth in the preamble and the following exhibits are incorporated into and made a part of this Agreement:

- a. Exhibit 1 – Site map(s) of the Property (or upgrades thereto), as amended from time to time and approved by the Village, showing the Tower Space and the Ground Space, together with the areas on the Property licensed to Licensee to provide access

and utility service to the Ground Space (collectively the "Licensed Premises") which includes location of any proposed underground utilities necessary for operation of the Antenna.

b. Exhibit 2 – Plans and specifications (or upgrades thereto), as amended from time to time and approved by the Village, for the Antenna and any cables or utility lines installed on the Licensed Premises and the equipment cabinets to be installed on the License Premises and used for housing of the related Antenna equipment (collectively, the "Licensee Improvements").

c. Exhibit 3 - Plans and specifications (or upgrades thereto), as amended from time to time and approved by the Village, for the Antenna and any cables or utility lines installed on the Licensed Premises for any sublicensee.

2. Section 3. "SPECIFICATIONS", the first sentence of paragraph (b) of the Agreement shall be deleted in its entirety.

3. Section 4. "CONSTRUCTION, INSTALLATION AND MAINTENANCE", paragraph (g) of the Agreement is stricken and amended as follows:

g. Licensee shall be entitled to access their equipment Monday through Friday, 7:00am to 3:30pm CST, by contacting the Village Building Services Department at 630/434-5551. If access is required after business hours, on weekends, on a holiday or in the event of an emergency, Licensee shall contact the Village Operations Center at 630/434-5706 or 630/434-5707

4. Section 6. "TERM" of the Agreement is amended to extend the term of the current Agreement. With this First Amendment, the Agreement shall be automatically renewed for two (2) additional, approximately five (5) year renewal terms as follows:

(c) The initial renewal term will commence on September 1, 2013 and shall end December 31, 2013. Thereafter, and as part and parcel of the initial renewal term, one additional five (5) year period shall automatically commence January 1st terminating on December 31, 2018. The second renewal term of this First Amendment shall automatically commence January 1, 2019 and shall end December 31, 2023, the final expiration date. Automatic renewal as provided herein will only cease upon at least one hundred twenty (120) days written notice of non-renewal in advance of the commencement of the second renewal term by one party to the other or until the final expiration date, which ever is sooner. Village agrees not to terminate this Agreement simply as a method to re-negotiate the terms contained herein.

After January 1, 2019, Licensee may request the Village to enter into negotiations toward renewing or extending this Agreement. Any renewal or extension shall be according to terms that are mutually agreeable and the Village shall not be bound to accept any particular terms or to renew any or all of the rights granted by this Agreement.

5. Section 7. "COMPENSATION", the second, third and fourth sentences of the Agreement are stricken and amended as follows:

Beginning on September 1, 2013, Licensee shall pay to the Village a license fee of \$4,500.00 per month each month of 2013. **Thereafter, effective on the first day of January in each subsequent year during the term of the Agreement, the monthly license fee shall increase in an amount equal to the fee for the preceding year multiplied by 4%.** The monthly fee shall be paid to the Village of Downers Grove, Village Hall, 801 Burlington Avenue, Downers Grove, IL 60515 each month by the 10th of the month.

6. Section 12. "TAXES" of the Agreement is stricken and amended as follows:

Section 12. TAXES. Licensee is solely responsible for payment of taxes on the leasehold (PIN # 09-06-307-014). Licensee is solely responsible to determine the taxes owed and to comply with the DuPage County payment procedures. Licensee shall reimburse the Village for any personal or real property taxes which are assessed as a result of Licensee's Improvements and directly attributable to its use of the Property under the terms of this First Amendment to the Agreement. Licensee shall have the right, at its own expense and without expense to the Village, to contest by appropriate proceedings, conducted with due diligence and in good faith, the validity of the amount of taxes or reassessment as applicable to the Licensed Premises or the Licensee Improvements. In the event that the Village becomes aware of any tax delinquency and that delinquency is not cured by the Licensee thirty (30) days from the date the Village sends written notice, the Village shall have the right to remove any of Licensee's equipment and terminate this First Amendment to the Agreement.

7. Section 16. "ASSIGNMENT" of the Agreement is stricken and amended as follows:

Section 16. ASSIGNMENT AND SUBLETTING. This Agreement may not be assigned or transferred without the express written consent of the Village, which shall not be unreasonably withheld, conditioned or delayed. The Village agrees to respond to any such request within thirty (30) days from receipt of the request. Any assignment or transfer without such written consent shall, at the option of the Village, be deemed to be void and of no effect. Provided, however, this Agreement may be assigned or transferred to Licensee's parent or subsidiary, successor legal entity or other affiliate of Licensee without the Village's written consent as long as the Village is given written notice of the assignment or transfer within thirty (30) days thereof.

The Village must approve any sublease to any entity that is not Licensee's parent or subsidiary, successor legal entity or other affiliate of Licensee and the Village shall be entitled to fifty percent (50%) of any such sublease in addition to the license fee as described in Section 7. COMPENSATION, above. Approvals shall not be unreasonably withheld, conditioned or delayed.

8. Section 21. "NOTICES" of the Agreement is amended to indicate the current addresses of each party:

To Village:
Village Manager
Village of Downers Grove
801 Burlington Avenue
Downers Grove, IL 60515
630.434-5500

With Copy to:
Village Attorney
Village of Downers Grove
801 Burlington Avenue
Downers Grove, IL 60515
630.434-5541

To Licensee:
SprintCom, Inc.
Sprint/Nextel Property Services
Site ID: CH03XC649
Mailstop KSOPHT0101-Z2650
6391 Sprint Parkway
Overland Park, KS 66251-2650

With Copy to:
Sprint/Nextel Law Department
Attn: Real Estate Attorney
Site ID: CH03XC49
Mailstop KSOPHT0101-Z2020
6391 Sprint Parkway
Overland Park, KS 66251-2020

9. Except as amended herein, all terms, conditions, provisions, covenants and agreements contained in the Agreement shall be reinstated and shall remain in full force and effect in their entirety. In the event of a conflict between this First Amendment and the Agreement, the First Amendment shall control. Each reference in the Agreement to itself shall be deemed also to refer to this First Amendment.

IN WITNESS WHEREOF, the parties have caused their properly authorized representatives to execute and seal this Agreement on the dates set forth below.

VILLAGE OF DOWNERS GROVE

SPRINTCOM, INC.

By: _____

By: *Nathan Olson*

Name: _____

Name: Nathan Olson

Title: Village Manager

Title: Authorized Representative

Date: _____

Date: 6/11/2012

Attest: _____

April Holden, Village Clerk

Subscribed and sworn to before me this
11TH day of JUNE, 2012.

Renet A. Mitchell
Notary Public

\\mw\agr.12\Sprint-DownersDr-Draft-4-13-12



EXHIBIT 1

SITE MAP(S)

(see attached)



SHEET INDEX

NO.	DESCRIPTION
T-1	TITLE SHEET
C-1	SITE PLAN
C-1A	ENLARGED SITE PLAN
C-2	PLATFORM LAYOUT
C-3	SITE ELEVATION
C-4	ANTENNA LAYOUT
C-5	RFDS FORT AND SITE DETAILS
C-6	ANTENNA DETAILS
C-7	EQUIPMENT DETAILS
E-1	UTILITY PLAN AND DETAILS
E-2	GROUNDING DIAGRAM AND NOTES

DRIVING DIRECTIONS

DEPART FROM SPRING CREEK
 4000 W. GRAND AVE. ELMHURST, IL 60120
 TURN RIGHT (NORTH) ONTO US-120 W. LAKE ST.
 KEEP STRAIGHT ONTO US-70 E. LAKE ST.
 TURN LEFT (SOUTH) ONTO LOCAL ROAD(S).
 TAKE RIGHT ONTO SR-36 W. WILSON RD.
 TAKE RIGHT ONTO SR-36 W. WILSON RD.
 KEEP STRAIGHT ONTO SR-36 E. BUTTERFIELD RD.
 TURN RIGHT ONTO N. HIGHLAND AVE.
 MERGE ONTO US-34 WILSON AVE.
 TURN RIGHT (WEST) ONTO US-34 OGDEN AVE.
 TURN LEFT (SOUTH) ONTO LEE AVE.
 TURN LEFT (EAST) ONTO GLEN AVE.
 TURN LEFT (EAST) ONTO LOCAL ROAD(S).
 ARRIVE AT SITE.

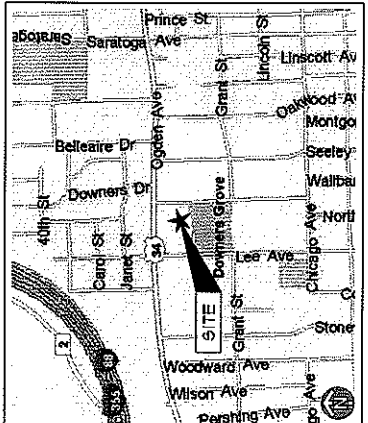
VICINITY MAP

Sprint
 SITE NAME
DOWNERS DRIVE WT

CH03XC649
 SITE NUMBER

4318 DOWNERS DRIVE
DOWNERS GROVE, IL 60518
 SITE ADDRESS

NETWORK VISION
 PROJECT TYPE

PROJECT SUMMARY

SITE NAME:	DOWNERS DRIVE WT
SITE NO.:	CH03XC649
SITE ADDRESS:	4318 DOWNERS DRIVE DOWNERS GROVE, IL 60518
SCANDL:	DUPAGE
SITE COORDINATES:	(FROM 7C LETTER) NAD 83 N. 416070.4' E. 862757.47' T-S
LANDUSE:	VILLAGE OF DOWNERS GROVE
ADDRESS:	4318 DOWNERS DRIVE DOWNERS GROVE, IL 60518
LANDLORD:	SPRINT 400 W. GRAND AVE. ELMHURST, ILLINOIS 60120
BUILDING CODE:	VILLAGE OF DOWNERS GROVE 801 BURLINGTON AVE DOWNERS GROVE, IL 60518 (630) 434-5500
ELECTRICAL CODE:	INTERNATIONAL BUILDING CODE 2006 EDITION NATIONAL ELECTRICAL CODE 2008 EDITION

ENGINEER'S LICENSE

CERTIFICATION STATEMENT:
 I CERTIFY THAT THESE DRAWINGS WERE PREPARED BY ME OR UNDER MY CLOSE PERSONAL SUPERVISION AND TO THE BEST OF MY KNOWLEDGE AND BELIEF COMPLY WITH THE REQUIREMENTS OF THE INTERNATIONAL BUILDING CODE, 2006 EDITION

LICENSED ENGINEER - STATE OF ILLINOIS

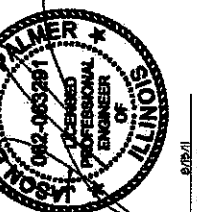

APPROVALS

DATE	DATE
DATE	DATE
DATE	DATE
DATE	DATE

SIGNED DATE: 8/28/11
 EXPIRES: 12/31/2011
 LICENSE NO. 092-0632801

PROJECT TEAM

BLACK & VEATCH Building a world of difference. 1600 S. COUNTY LINE RD. BURR RIDGE, IL 60521 TEL: 630-185-1500	PROJECT MANAGERS
Fulltron Engineering Consultants 9600 W. BRYN MAJOR AVE. ROSEMONT, IL 60018 TEL: 847-237-0200 FAX: 847-237-0206 www.FulltronEngineering.com	ENGINEERS
Real Estate Consulting Services 2210 MIDWEST RD. SUITE 213 OAK BROOK, IL 60153 TEL: (773) 360-8781	SITE ACQUISITION

SCOPE OF WORK:

- HANDICAP ACCESS REQUIREMENTS ARE NOT REQUIRED
- FACILITY IS UNHABITABLE AND NOT FOR HUMAN HABITATION
- FACILITY HAS NO FLUORINE OR REFRIGERANTS
- THIS FACILITY SHALL MEET OR EXCEED ALL FAA AND FCC REGULATORY REQUIREMENTS
- ALL NEW MATERIAL SHALL BE FURNISHED AND INSTALLED BY CONTRACTOR UNLESS NOTED OTHERWISE
- CABLES, ANTENNAS, AND CABLES FURNISHED BY OWNER AND INSTALLED BY CONTRACTOR

INSTALL NEW ANTENNAS/RISERS ON EXISTING WATER TOWER
 INSTALL NEW CABINETS ON EXISTING STEEL PLATFORM
 REMOVE EXISTING CDMA ANTENNAS, COAX CABLES AND CABINETS OR EQUIPMENT

BLACK & VEATCH
 Building a world of difference.

1600 S. COUNTY LINE RD.
 BURR RIDGE, IL 60521
 TEL: 630-185-1500

Sprint
 400 W. GRAND AVE.
 ELMHURST, ILLINOIS 60120
 TEL: (630) 378-5100
 FAX: (630) 378-5101

Fulltron Engineering Consultants
 9600 W. BRYN MAJOR AVE.
 ROSEMONT, ILLINOIS 60018
 TEL: 847-237-0200
 FAX: 847-237-0206
 www.FulltronEngineering.com

APPROVED BY: JP
 DATE: 8/28/11
 DATE: 8/28/11
 DATE: 8/28/11
 DATE: 8/28/11

DATE ISSUED:
DOWNERS DRIVE WT

SITE ADDRESS:
CH03XC649

SHEET NAME:
**4318 DOWNERS DRIVE
DOWNERS GROVE, IL 60518**

TITLE SHEET
T-1

SHEET NUMBER

THIS DRAWING IS THE PROPERTY OF FULLTRON ENGINEERING CONSULTANTS, INC. IT IS FOR THE EXCLUSIVE USE OF THIS PROJECT. ANY REUSE OF THIS DRAWING WITHOUT THE EXPRESSED WRITTEN CONSENT OF FULLTRON ENGINEERING CONSULTANTS, INC. IS PROHIBITED.

BLACK & VEATCH
Building a world of difference.

1600 S. COUNTY LINE RD.
DENVER, CO 80202
TEL: 303-733-1000

Sprint
4000 W. GRAND AVE.
DENVER, CO 80202
TEL: 303-733-1000

ILLIOTT, PALMER & SIOLLING
Professional Engineers
9600 W. BRYN MAUR AVE.
ROSEMONT, IL 60018
TEL: 630-581-0700
FAX: 630-581-0700
www.illipalmer.com

#	DATE	DESCRIPTION	INT.
1	10/11/11	50% REVISED	JV
2	01/11/12	FINAL	WK

APPROVED BY: [Signature]

DATE SHOWN: [Blank]

SITE NAME: **DOWNERS DRIVE W/T**

SITE NO.: **CH03XC649**

SITE ADDRESS: **438 DOWNERS DRIVE
DOWNERS GROVE, IL 60515**

SHEET NAME: **ELEVATION AND NOTES**

SHEET NUMBER: **C-3**

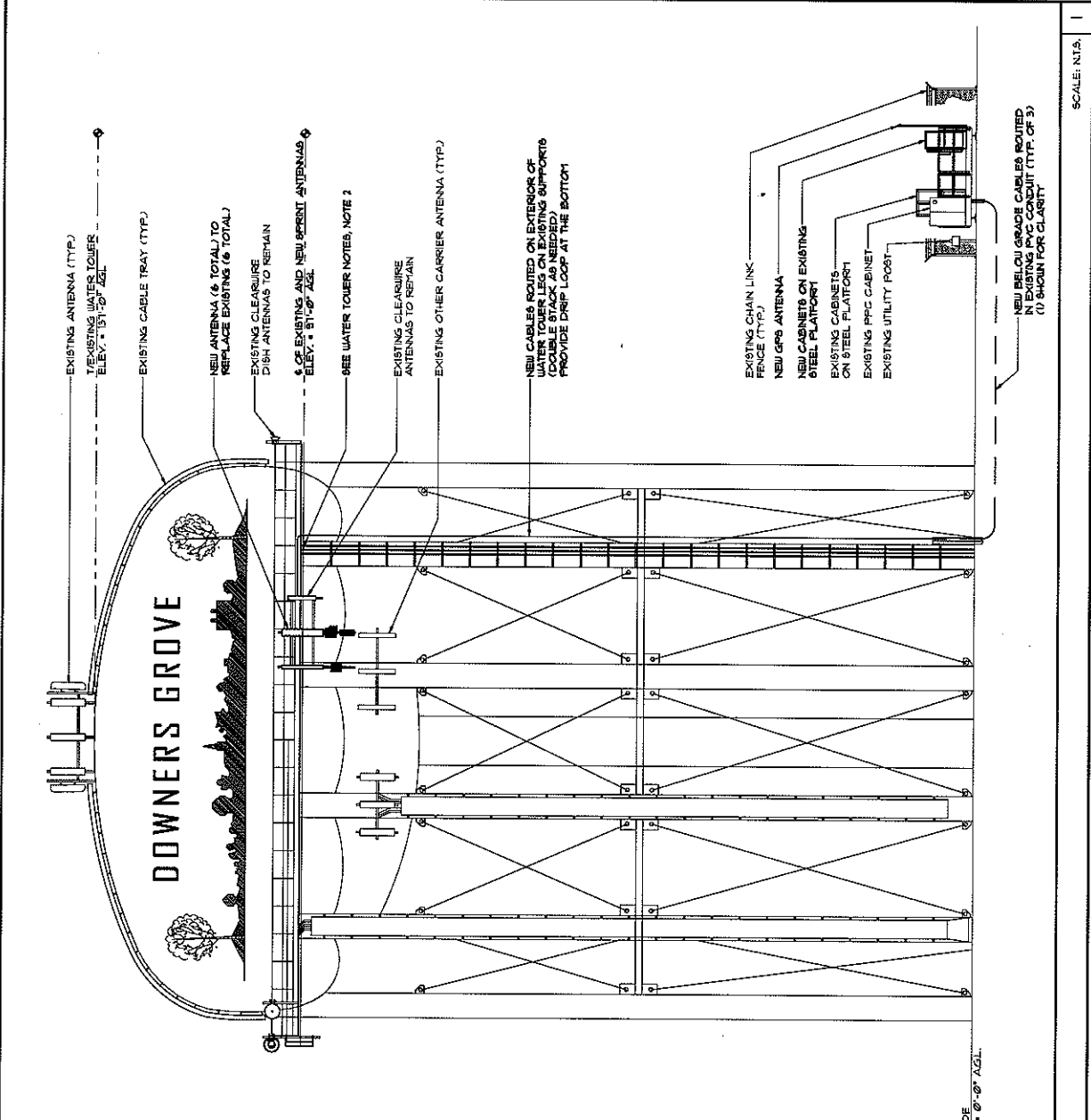

STRUCTURAL NOTE:
STRUCTURAL CALCULATIONS PREPARED BY ILLIOTT ENGINEERING CONSULTANTS INC DATED AUGUST 15, 2011. CONTRACTOR TO VERIFY WITH PROJECT MANAGER TO OBTAIN A COPY.

WATER TOWER NOTES:

- ANTENNAS AND ASSOCIATED EQUIPMENT OF SUCH A CO-LOCATED FACILITY MUST BE OF A NEUTRAL COLOR THAT IS IDENTICAL TO OR CLOSELY COMPATIBLE WITH COLOR OF WATER TOWER.
- CONTRACTOR TO VERIFY AVAILABLE SPACE IN EXISTING FOUNDATION. ADDITIONAL PENETRATIONS ARE PERMITTED IN THE FOUNDATION WHICH MUST BE INCLUDED IN THESE DRAWINGS. CONTACT ENGINEER FOR ADDITIONAL DETAILS.

PAINTING AND SAFETY:

- CONTRACTOR SHALL PROVIDE ALL SAFETY EQUIPMENT AND FALL PROTECTION TO INSURE THE SAFETY OF ON SITE PERSONNEL DURING CONSTRUCTION.
- ACCESS TO THE TANK INTERIOR WATER COMPARTMENT SHALL NOT BE PERMITTED WITHOUT THE APPROVAL OF THE WATER DEPARTMENT SUPERVISOR. PRECAUTIONS SHALL BE TAKEN TO PREVENT WATER CONTAMINATION.
- THE PAINT SYSTEM SHALL BE CHECKED FOR HAZARDOUS METALS. WHERE HAZARDOUS METALS ARE FOUND IN THE PAINT SYSTEM, THE ENVIRONMENT AND WORKERS MUST BE PROTECTED FROM CONTAMINATION.

PAINTING:

- BLAST CLEANING:**
 - AGGRESSIVE BLAST CLEAN ALL NEW STEEL COMPONENTS TO REMOVE ALL OIL, GREASE, AND OTHER CONTAMINANTS PRIOR TO APPLICATION OF PRIMER COAT.
 - AFTER WELDING OR CUTTING, CLEAN ALL DAMAGED SURFACES IN ACCORDANCE WITH SSPC-SP11 "POWER TOOL CLEANING" CONDITION PRIOR TO APPLICATION OF PRIMER COAT.
- COATINGS EXTERIOR - 3 COATS**
 - THE THREE COAT EXTERIOR PAINT SYSTEM WILL BE APPLIED TO THE EXTERIOR OF THE TOWER. ONE COAT OF INTEC SERIES 1074, PAINT THE EXTERIOR TO MATCH THE EXISTING TOP COAT COLOR.
 - THE THREE-COAT SYSTEM WILL BE APPLIED AT 2.0 - 3.0 MILS PER COAT, TO A THICKNESS OF 6.0 - 9.0 MILS.
- COATINGS INTERIOR - 2 COATS**
 - THE TWO COAT INTERIOR PAINT SYSTEM WILL BE APPLIED TO THE INTERIOR OF THE TOWER. ONE COAT OF INTEC SERIES 1074, PAINT THE DRY INTERIOR TO MATCH THE EXISTING TOP COAT COLOR.
 - THE TWO-COAT SYSTEM WILL BE APPLIED AT 3.0 - 4.0 MILS PER COAT, TO A THICKNESS OF 6.0 - 8.0 MILS.
- COATINGS (DRY INTERIORS)**
 - IF DRY INTERIORS ARE FOUND, THE DRY INTERIOR PAINT SYSTEM WILL BE APPLIED TO MATCH THE EXISTING TOP COAT COLOR.
 - THE TWO-COAT SYSTEM WILL BE APPLIED AT 3.0 - 4.0 MILS PER COAT, TO A THICKNESS OF 6.0 - 8.0 MILS.

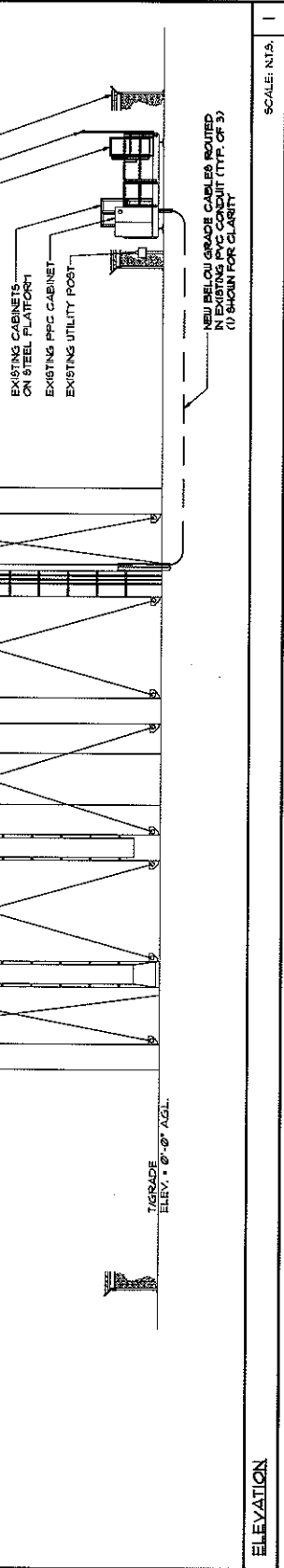

Sprint
Site: 4414 Downers Dr
Site No: CHO3XC649-C

EXHIBIT 2

PLANS AND SPECIFICATIONS

(see attached)

BLACK & VEATCH
Building a world of difference.



1600 S. COUNTY LINE RD.
BURNS RIDGE, IL 60621
TEL: 630-793-1929

1005 W. GRAND AVE
ELECTRONIC CENTER BLDG 116
TEL: (630) 378-9100
FAX: (630) 378-5701

PEE
Paleron Engineering Consultants
9600 W. BIRN MALL AVE.
ROSEMONT, ILLINOIS 60018
TEL: 847-293-0700
FAX: 847-293-0701
DESIGNATED BY: 184 0209268
www.Paleron.com (near 103.com)

APPROVED BY:	DATE:	DESCRIPTION:
CP	1/2/11	SPRINT REVIEW
JV		FINAL
JK		FINAL

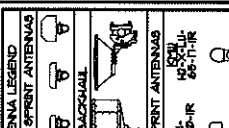

DATE BORN: _____
SITE NAME:
DOWNERS DRIVE W

SITE NO:
CH03XC649

SITE ADDRESS:
4515 DOWNERS DRIVE
DOWNERS GROVE, IL 60515

SHEET NAME:
**SECTOR 2
ANTENNA
LAYOUT**
SHEET NUMBER:
C-4B

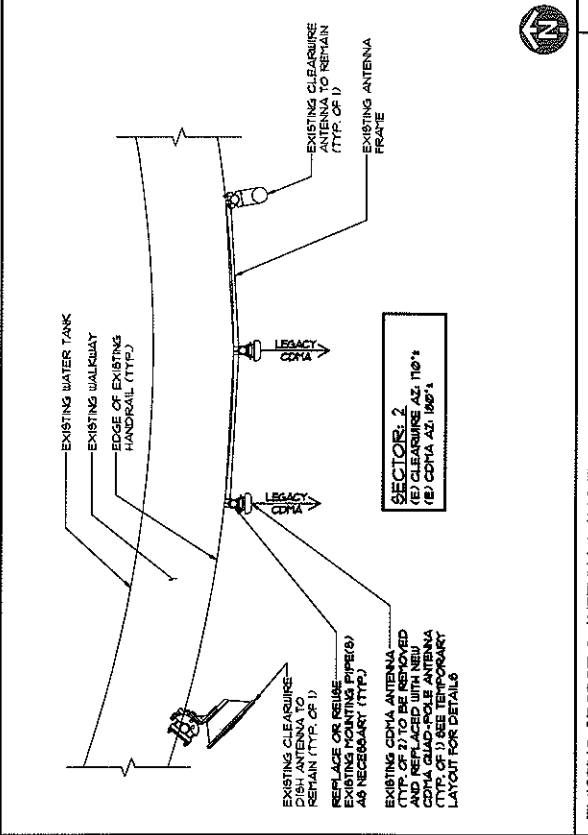
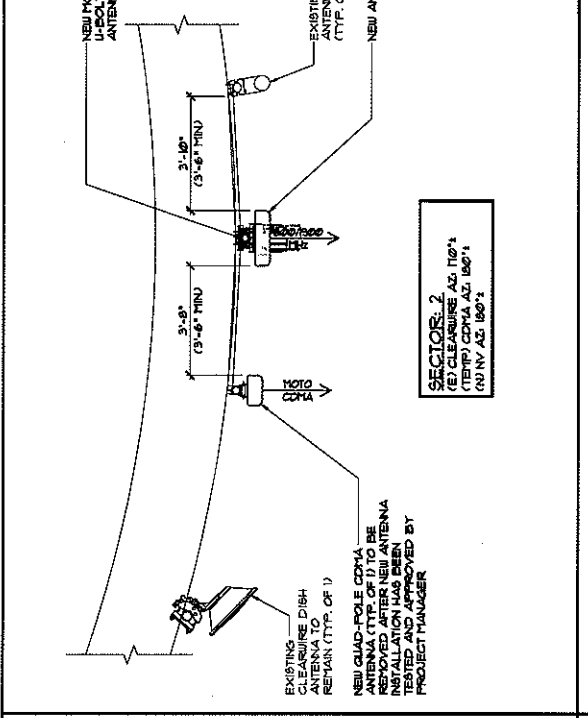

SCALE: 1/4" = 1'-0" 2 TEMPORARY SECTOR 2 ANTENNA LAYOUT

SCALE: 1/4" = 1'-0" 1 EXISTING SECTOR 2 ANTENNA LAYOUT

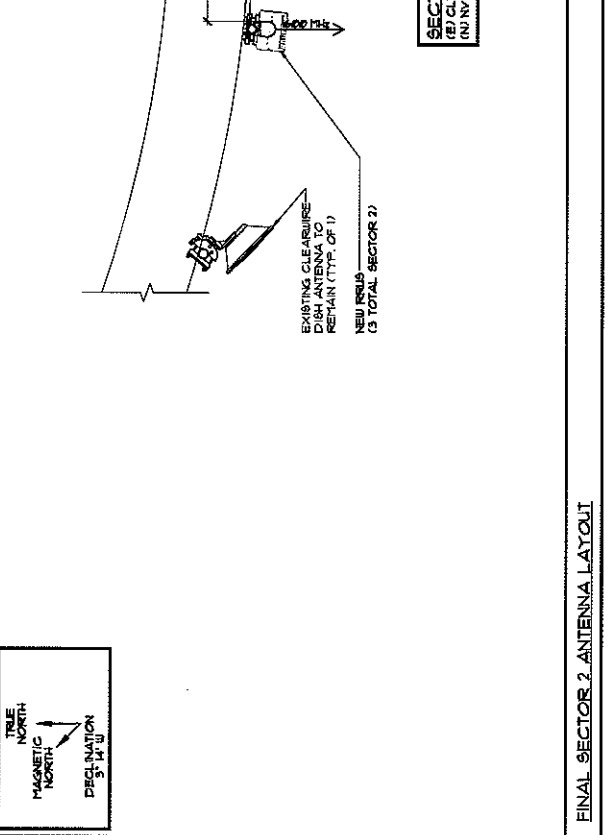
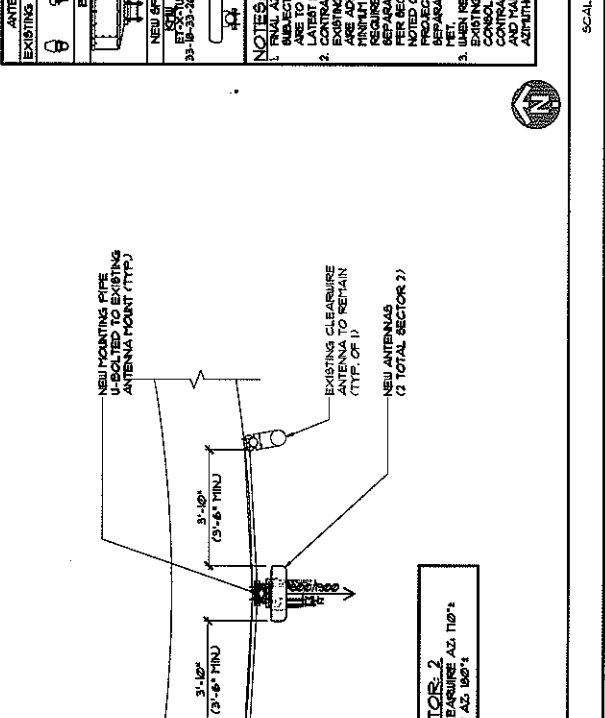

SCALE: 1/4" = 1'-0" 3 FINAL SECTOR 2 ANTENNA LAYOUT

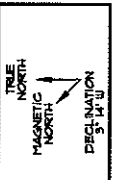

- NOTES:**
- FINAL AZIMUTHS ARE SUBJECT TO REVISIONS AND ARE TO BE VERIFIED WITH AN ON-SITE SURVEY.
 - CONTRACTOR TO VERIFY EXISTING ANTENNA FRAMES ARE ADEQUATE TO MEET SEPARATION & TYPICAL SEPARATION IS TYPICAL PER SECTOR UNLESS NOTED OTHERWISE. NOTIFY PROJECT MANAGER IF SEPARATION CANNOT BE MET.
 - WHEN REPLACING EXISTING ANTENNAS FOR CONTRACTOR TO VERIFY AND MAINTAIN EXISTING AZIMUTHS AND HEIGHT.

ANTENNA LEGEND

	EXISTING SPRINT ANTENNAS
	BACKHAUL
	NEW SPRINT ANTENNAS
	EXISTING COHA
	NEW COHA

NEW SPRINT ANTENNAS
ELEVATION: 85'-11"-R
33-19-33-20-IR

BLACK & VEATCH
Building a world of difference

1655 S. COUNTY LINE RD.
DES MOINES, IOWA 50319
TEL: 632-199-1900

Sprint

400 W. GRAND AVE
E. DES MOINES, IOWA 50316
TEL: 319-271-1000
FAX: (632) 375-5101

FECC
Professional Engineering Consultants
ROSEHART, ILLINOIS 60018
TEL: 847-332-0700
FAX: 847-332-0706
www.FilteronEngineering.com

NO.	DATE	DESCRIPTION	BY	CHK
1	7/2/01	30% REVISED	JV	
2	8/2/01	FINAL	JK	

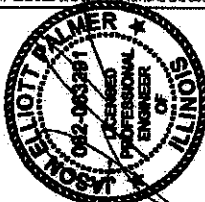

DATE BASED: _____

SITE NAME:
DOWNERS DRIVE WT

SITE NO.:
CH03XC649

SITE ADDRESS:
**4515 DOWNERS DRIVE
DOWNERS GROVE, IL 60130**

SHEET NAME:
**ANTENNA
DETAILS**

SHEET NUMBER:
C-6

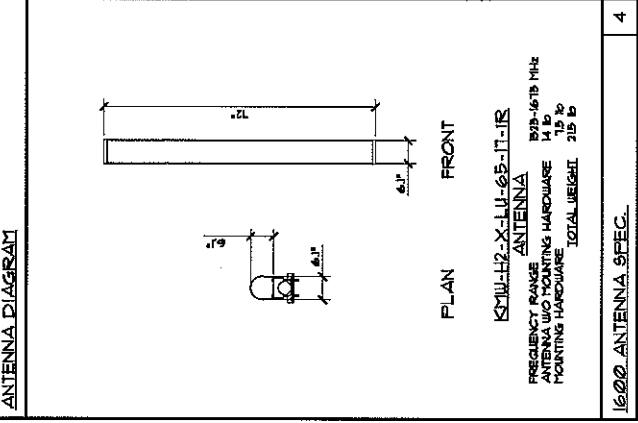
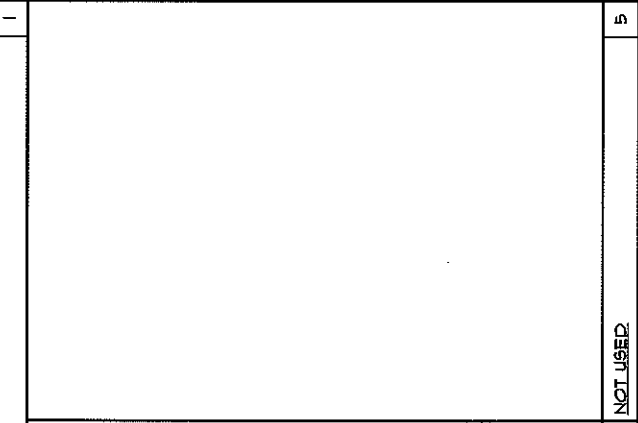
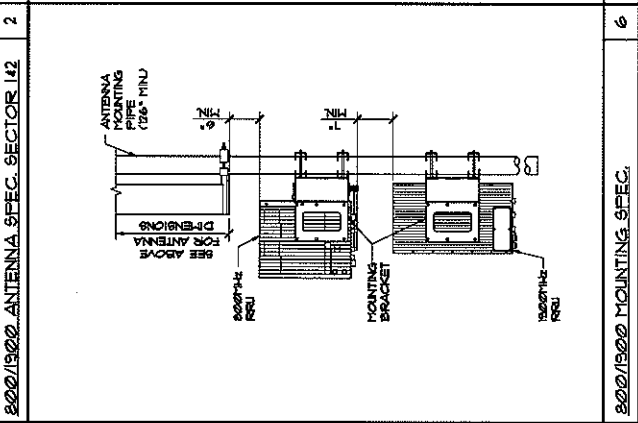
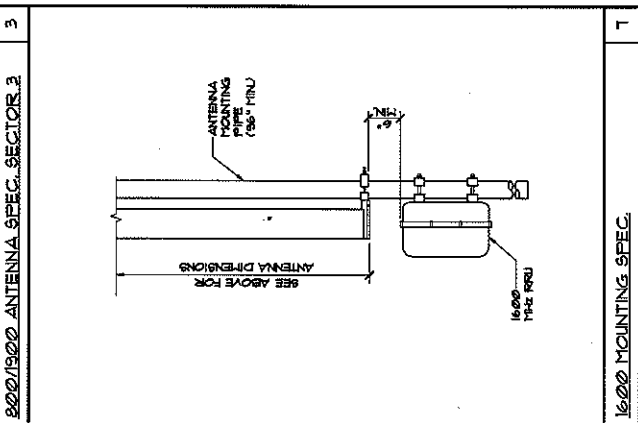
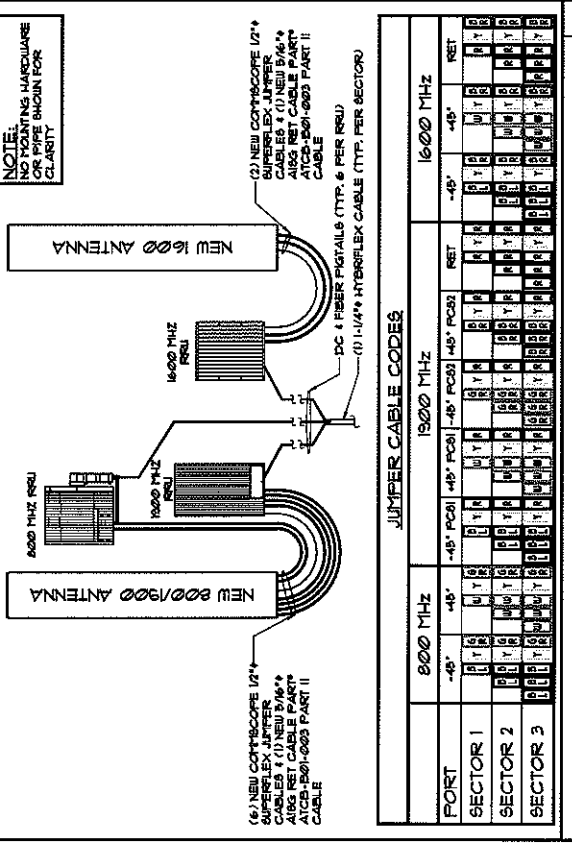
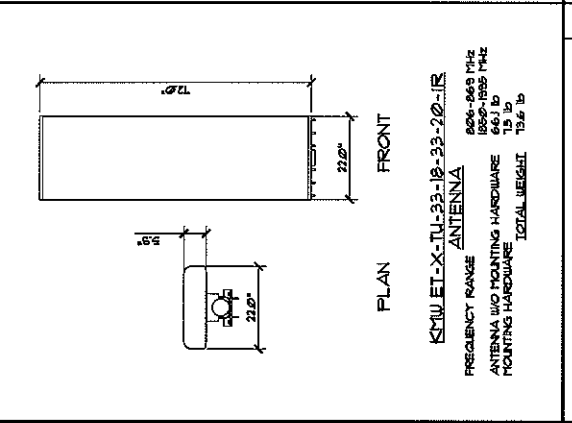
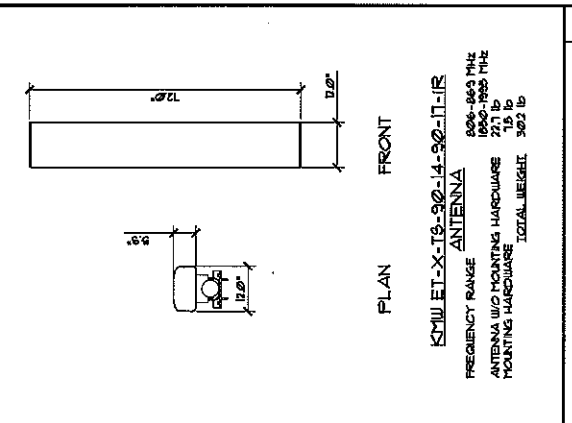

1	200/1900 ANTENNA SPEC. SECTOR 3	3
2	200/1900 ANTENNA SPEC. SECTOR 142	6
3	200/1900 ANTENNA SPEC. SECTOR 142	6
4	NOT USED	5
5	NOT USED	5
6	NOT USED	5
7	1600 MOUNTING SPEC.	1

THIS DRAWING IS THE PROPERTY OF ALBERTON ENGINEERS CONSULTANTS, INC. IT IS FOR THE EXCLUSIVE USE OF THIS PROJECT AND REUSE OF THIS DRAWING WITHOUT THE EXPRESSED WRITTEN CONSENT OF ALBERTON ENGINEERS CONSULTANTS, INC. IS PROHIBITED.

BLACK & VEATCH
 Building a world of difference.
 1600 S. COUNTY LINE RD.
 PULASKI RIDGE, IL 62454
 TEL: (630) 799-1800
 FAX: (630) 799-5101

Sprint
 400 W. GRAND AVE.
 ELKHART, IN 46520
 TEL: (317) 519-5200
 FAX: (317) 519-5101

AECC
 Fullerton Engineering Consultants
 9600 W. BRYAN BLVD. AVE.
 ROSEMONT, ILLINOIS 60018
 TEL: 847-795-0200
 FAX: 847-795-0202
 DESIGN FIRM NO. BA-0202488
 www.FullertonEng.com

#	DATE	DESCRIPTION	BY	CHK
1	10/21/09	50% REVIEW	JV	
2	01/21/10	FINAL	JK	

APPROVED BY: [Signature]
 CHECKED BY: [Signature]

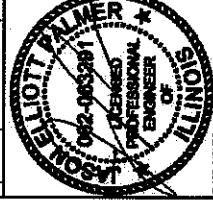

DATE PAGES:	SITE NAME:
DOWNERS DRIVE WT	DOWNERS DRIVE WT
SITE NO.:	CH03XC649
SITE ADDRESS:	488 DOWNERS DRIVE DOWNERS GROVE, IL 60130
SHEET NAME:	EQUIPMENT DETAILS
SHEET NUMBER:	C-7

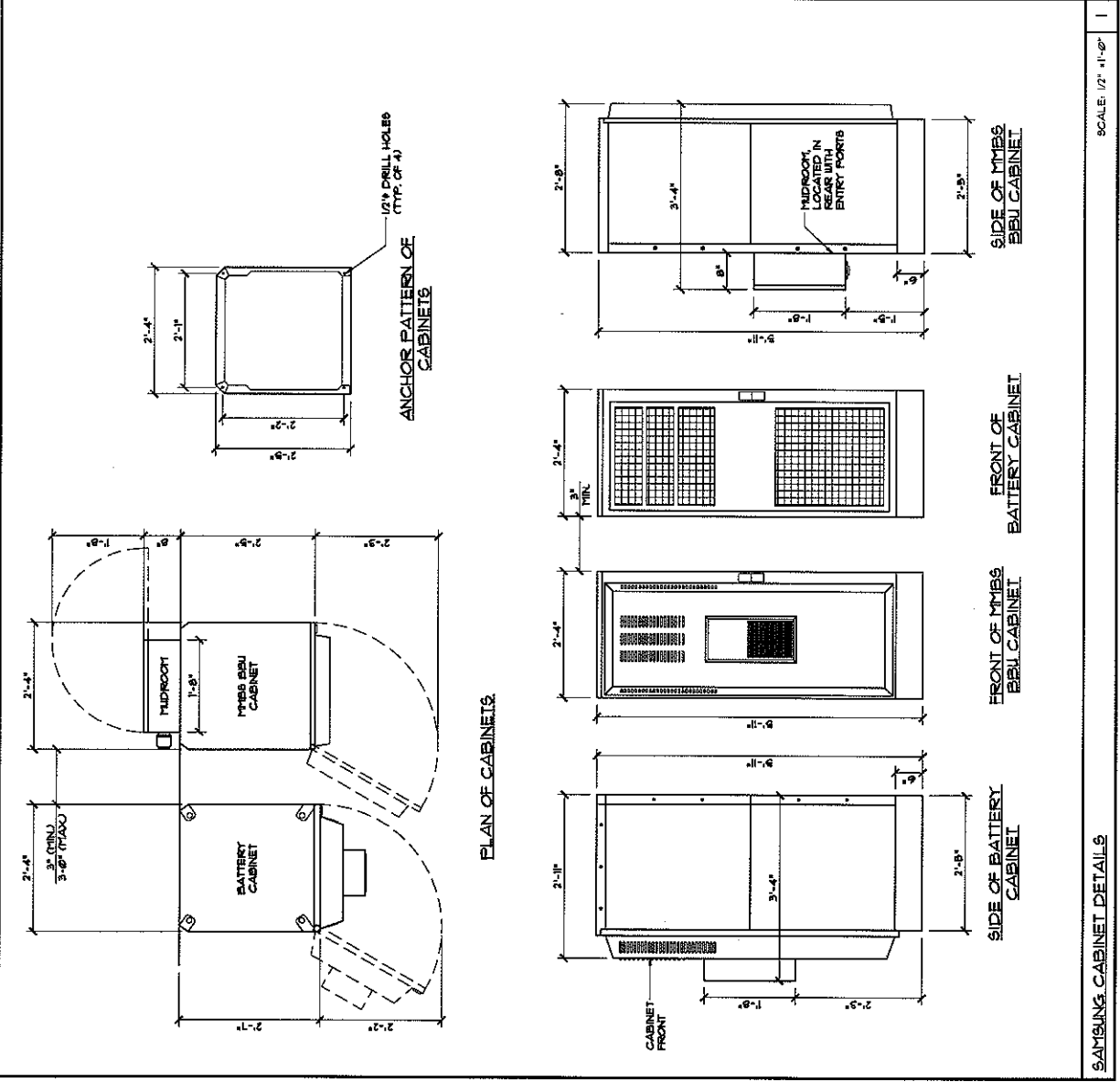
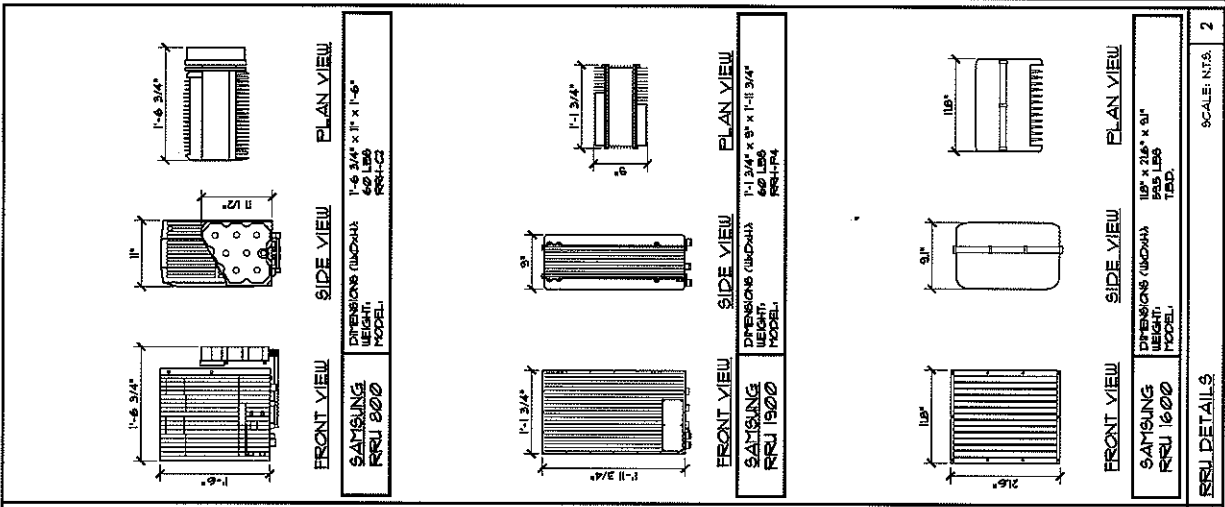

SAMSUNG CABINET DETAILS | SCALE: 1/2" = 1'-0" | 2

RESOLUTION NO. 98-38

A RESOLUTION AUTHORIZING EXECUTION OF THREE LICENSE AGREEMENTS BETWEEN THE VILLAGE OF DOWNERS GROVE AND SPRINTCOM, INC. TO INSTALL, MAINTAIN AND OPERATE ANTENNA EQUIPMENT ON VILLAGE PROPERTY LOCATED AT 4318 DOWNERS DRIVE, 3301 FINLEY ROAD AND 5235 KATRINE

BE IT RESOLVED by the Village Council of the Village of Downers Grove, DuPage County, Illinois, as follows:

1. That the form and substance of certain License Agreements (the "Agreements"), between the Village of Downers Grove (the "Village") and SprintCom, Inc. for the installation, maintenance and operation of SprintCom antenna equipment on Village property located at 4318 Downers Drive, 3301 Finley Road and 5235 Katrine, as set forth in the form of the Agreements submitted to this meeting with the recommendation of the Village Manager, are hereby approved.

2. That the Mayor and Village Clerk are hereby respectively authorized and directed for and on behalf of the Village to execute, attest, seal and deliver the Agreements, substantially in the form approved in the foregoing paragraph of this Resolution, together with such changes as the Manager shall deem necessary.

3. That the proper officials, agents and employees of the Village are hereby authorized and directed to take such further action as they may deem necessary or appropriate to perform all obligations and commitments of the Village in accordance with the provisions of the Agreements.

4. That all resolutions or parts of resolutions in conflict with the provisions of this Resolution are hereby repealed.

5. That this Resolution shall be in full force and effect from and after its passage as provided by law.

Betty M. Cheever
Mayor

Passed: July 6, 1998
Attest: April H. Hold
Village Clerk

LICENSE AGREEMENT BETWEEN THE VILLAGE OF DOWNERS GROVE AND SPRINTCOM, INC. TO INSTALL, MAINTAIN AND OPERATE ANTENNA EQUIPMENT ON VILLAGE PROPERTY

WITNESSETH

WHEREAS, the Village of Downers Grove (hereinafter referred to as the "Village") is an Illinois municipal corporation and a home rule unit, pursuant to the laws of the State of Illinois; and

WHEREAS, the Village is the owner of certain real estate located at 3301 Finley Road, Downers Grove, Illinois, upon which is located a Village water tower known as the Finley Tower (hereinafter referred to as the "Tower"); and

WHEREAS, SprintCom, Inc., a Kansas Corporation (hereinafter referred to as the "Licensee") has requested permission to install communications antennae and related equipment (hereinafter referred to as the "Antenna") on the top of the Tower (the "Tower Space") and certain related equipment in cabinets on the ground (the "Ground Space"); and

NOW, THEREFORE, in consideration of the mutual promises, covenants and conditions, the Village and the Licensee agree as follows:

1. **CONTRACT DOCUMENTS:** The provisions set forth in the preamble and the following exhibits are incorporated into and made a part of this Agreement:
 - a. Exhibit 1 - Site map of the Property titled ^{629 B Downers Grove Water Tank - Site & Eq. Plans - Sheet A-1,} dated Cover sheet 5/18, 1998, and approved by the Village on 6/11, 1998, as ^{marked and amended,}
 - b. Exhibit 2 - Plans and specifications titled ^{629 B Downers Grove Water Tank - Sheets A2 to A4 & E-1 to E-3,} dated Cover sheet 5/18, 1998, and approved by the Village on 6/11, 1998, as ^{marked and amended,}

2. **GRANT OF LICENSE:** The Village hereby grants to the Licensee the license, right, permission and authority to install, operate and maintain the Licensed Improvements upon the terms and conditions hereinafter specified. The license shall not terminate upon the sale, assignment or transfer of the property, but shall run with the land.

3. **SPECIFICATIONS:** The Licensee shall comply with the following specifications:

a. ***In general:*** During the term of this agreement, there shall be no variations, modifications, or upgrades from the plans and specifications of Exhibits 1 and 2 without the prior written approval of the Village, which shall not be unreasonably withheld, conditioned or delayed.

b. ***Antenna:*** The Antenna shall be for the operation of radio frequency: receive 1865-1870 & 1885-1990; transmit 1945-1950 & 1965-1970. The Antenna shall be installed, attached to the Tower, and maintained in conformance with Exhibit 2 and any applicable state of federal requirements. The Antenna shall be located more than ten (10) feet from any existing antenna equipment and shall not exceed sixty (60) inches in height.

4. **CONSTRUCTION, INSTALLATION AND MAINTENANCE:** The Licensee may install, repair, maintain, or replace the Antenna, subject to the following conditions:

a. Licensee shall obtain all required permits and authorizations from the Village, in accordance with the applicable ordinances, prior to commencing any work under this agreement. Such work shall comply with applicable codes and regulations and shall be conducted in a workmanlike manner.

b. The Licensee shall obtain all necessary approvals from any regulatory authorities for the operation of the Licensee Improvements. Further, the Licensee shall comply with all applicable laws and regulations of such regulatory authorities including, but not limited to, the Federal Communications Commission.

c. All costs connected with the installation, maintenance, repair, use and removal of the Licensee Improvements shall be the responsibility of the Licensee.

d. The Licensee shall not take any action or allow any action to be done which may impair the use of or damage the Tower.

e. The Licensee may not interfere with the use by the Village, its officers, agents and employees, of the Tower or the property on which it is located.

f. Except for emergency situations, the Village shall provide reasonable advance notice to Licensee when it conducts any Tower repair or maintenance work that affects the Antenna or function of the Antenna or any of the Licensee Improvements.

g. Licensee shall be entitled to access the equipment located on the Ground Space twenty-four (24) hours a day, seven days a week. Licensee shall provide Village reasonable advance notice when access to the Tower Space is needed. Keys to the Tower can only be obtained between the hours of 8:00 a.m. and 4:00 p.m. from the Village Operations Center, or in the event of an emergency after hours, by calling (630) 434-5706 or 5707.

h. The Licensee shall maintain the Licensed Premises in good repair, and in a clean and sightly condition.

i. Upon termination of this Agreement by either party, the Licensee shall, within thirty (30) days and at its expense, remove the Licensee Improvements and restore the Licensed Premises to substantially its original condition, reasonable wear and tear and casualty loss excepted.

j. If Licensee abandons its use of the Antenna, Licensee shall, within thirty (30) days of receipt of written notice from the Village notifying the Licensee of such abandonment and at its expense, remove the Licensee Improvements and restore the Licensed Premises to substantially its original condition. Licensee Improvements will be presumed abandoned if it is not operated for a period of one month or more. If the Licensee Improvements are not removed within thirty (30) days, the Village may remove the Licensee Improvements and the Licensee shall reimburse the Village for the costs of such removal.

5. **NON-INTERFERENCE WITH VILLAGE OPERATIONS:** Neither this license nor the Licensee Improvements shall interfere or obstruct the functioning of the Village's operations and services. Licensee warrants that the Licensee Improvements shall be constructed, installed, maintained and operated in such a manner as to not interfere or obstruct any radio or electronic equipment or signals of the Village's radio and data systems. In the event such interference occurs, and the interference cannot be eliminated by Licensee after reasonable efforts, the Village may terminate this Agreement. Provided after notice to Licensee, the Village may immediately terminate this Agreement, or require that operation of the Antenna or any of the Licensee Improvements be immediately ceased where it determines that the Antenna or the Licensee Improvements present an immediate and serious danger to the public health, welfare or safety due to interference with the operation of the Village's radio and data systems.

6. **TERM:**

(a) Unless extended pursuant to Paragraph 5(b), this License shall have an Initial Term beginning September 1, 1998 or upon receipt of a building permit, whichever occurs first (the "Commencement Date") and ending August 31, 2003, and two (2) five-year Extension Terms beginning September 1, 2003, and September 1, 2008, respectively. The first Extension Term beginning September 1, 2003 shall automatically commence. The second Extension Term beginning September 1, 2008, shall automatically commence unless either party provides the other party with written notice of its election not to renew the License at least one hundred and twenty (120) days prior to the expiration of the current term.

(b) After June 1, 2013, Licensee may request the Village to enter into negotiations towards renewing or extending this Agreement beyond August 31, 2013. Such renewal or extension shall be according to terms that are mutually agreeable and the Village shall not be bound to accept any particular terms or to renew any or all of the rights granted by this Agreement.

7. **COMPENSATION:** Beginning on the Commencement Date, Licensee shall pay to the Village a license fee of \$2,250.00 per month for the first year of the Agreement. Thereafter, effective on each annual anniversary of the Commencement Date, the monthly license fee shall increase in an amount equal to the fee for the preceding year multiplied by 1.04 (104%). The amount shall be prorated for any fractional month at the beginning or at the end of a term. The fee shall be paid to the Village of Downers Grove, Village Hall, 801 Burlington Avenue, Downers Grove, IL 60515.

8. **TERMINATION:** This Agreement may be terminated as follows:

(a) After the Commencement Date, Licensee may terminate this Agreement at any time upon sixty (60) days written notice to the Village without further liability if Licensee does not obtain all permits or other approvals required from any governmental authority or any easements required from any third party to operate the PCS system, or if any such approval is canceled, expires or is withdrawn or terminated, or if Licensor fails to have proper ownership of the site or authority to enter into this Agreement, or if Licensee, for any other reason, in its sole discretion, determines that it will be unable to use the Property, however, if Licensee terminates this Agreement without cause, it shall pay the Village a termination penalty equal to three months of the current rental amount.

(b) In the event either party fails to comply with the terms of this Agreement such party shall be considered in default and the non-defaulting party may serve written notice of its intent to terminate the Agreement and the license. Except where the public health or safety is threatened, the notice shall give the defaulting party not less than thirty (30) days to correct such non-compliance. In the event the default is not corrected within thirty (30) days of such notice, the non-defaulting party may terminate this Agreement by serving a written notice of termination. Notwithstanding the preceding, if any default cannot be cured within thirty (30) days and the defaulting party has diligently commenced and continues to take reasonable action necessary to cure the default, the defaulting party shall be entitled to an extended reasonable period of time in order to complete the cure.

(c) In the event the Tower is destroyed or substantially damaged, this agreement shall be considered terminated.

9. **TOWER REPAIR/MAINTENANCE:** Upon receiving thirty (30) days notice from the Village that it intends to repair or perform maintenance to the Tower, Licensee shall, at its own expense and in such manner as the Village shall reasonably request, immediately remove, relocate, change or alter the position of the Antenna. During the term of this Agreement, the Tower may be refurbished and/or painted. Refurbishment and/or painting will take several months to complete (approximately five to eight months). Prior to beginning refurbishment and/or painting, Licensee understands that its Antenna shall be removed from the Tower upon notice from the Village and that the Antenna shall not be reinstalled until the refurbishment and/or painting is completed and the Village has approved such reinstallation. During such period, Licensee may, at its sole cost and expense, install the Antenna on a temporary telephone pole outside the shrouded area of the tower in a location approved by the Village. However, such temporary arrangement shall not interfere with the refurbishment and/or

painting of the tower or with other Village operations on the site. The Village shall not be responsible for any costs of removal, relocation, and reinstallation of the Antenna as a result of the refurbishment and/or painting.

10. **RESTORATION**: When the Licensee does any work on or affecting the Licensed Premises, it shall, at its own expense, restore the Licensed Premises to as good a condition as existed before the work was undertaken, unless otherwise directed by the Village. If the Licensee fails to restore the Licensed Premises, the Village may, after communications with the Licensee and after affording the Licensee a reasonable opportunity to correct the situation, restore the Licensed Premises and remove any obstruction therefrom. No such prior written notice shall be required in the event that the Village determines that an emergency situation exists. The Licensee shall pay the Village for any reasonable costs of such restoration within thirty (30) days after receiving a bill from the Village for such work.

11. **UTILITIES**: Licensee shall be responsible for obtaining adequate utilities for operation of the Licensee Improvements including electricity from any source available on the Property as long as the electricity for the Licensee Improvements are separately metered. Any utilities to be installed must be underground and the location approved by the Village. Licensee shall pay for the electricity or any other utility it consumes in its operations at the rate charged by the servicing utility company and the Village shall not be liable for such charges.

12. **TAXES**: Licensee shall either pay, or reimburse the Village, for any personal or real property taxes which are assessed as a result of the Licensee Improvements and use of the Licensed Premises under the terms of this Agreement. The Village shall provide to Licensee all assessment notices or tax bills received by the Village from any applicable taxing authority, within thirty (30) days after the Village's receipt of the same, but in no event later than fifteen (15) days prior to the deadline date for the filing of any objection or protest thereto. Licensee shall have the right, at its own expense and without expense to the Village, to contest by appropriate proceedings, conducted with due diligence and in good faith, the validity of the amount of any taxes or reassessment as applicable to the Licensed Premises or the Licensee Improvements.

13. **INDEMNIFICATION**:

(a) Licensee shall indemnify, become responsible for and save harmless the Village, its boards, committees, commissions, officers, agents and employees from any and all liability arising out of the existence of this Agreement; the installation, existence, maintenance or repair of the Licensee Improvements; or any act or omission of Licensee, its officers, agents and employees.

(b) The Village shall indemnify, become responsible for and save harmless Licensee, its officers, agents and employees from any and all liability arising out of the Village's ownership and use of the Property or any act or omission of the Village, its officers, agents and employees.

(c) For purposes of this Agreement, the term "liability" includes, but is not limited to: actual or claimed loss or damage to property or injury to or death of persons; actual or claimed responsibility for such loss, damage, injury or death; and any and all judgments, decrees, costs and expenses of every sort and kind of incident to such loss, damage, injury, death or responsibility, including, but not limited to, court costs, fines and attorney's fees.

14. **INSURANCE:** At all times while this Agreement remains in effect, and in recognition of the indemnification provided in the foregoing Paragraph 13, the Licensee shall, at its own cost and expense, maintain a program of third party liability insurance and/or self-insurance to protect the Village, its officers, employees and agents from any liability for bodily injury, death, and property damage occasioned by the activities of the Licensee under this Agreement, as follows:

(a) *During the Term of the Agreement.* Licensee shall procure, pay for and maintain in full force and effect during the entire term of the Agreement (i) worker's compensation insurance as required by law and which insures against worker's compensation claims arising out of Licensee's activities on the Tower; (ii) fire and casualty insurance covering the Licensee Improvements in an amount not less than one hundred percent (100%) of their actual replacement cost; and (iii) commercial general liability insurance, including broad form property damage insurance, for bodily injuries and property damage, in amounts not less than one million dollars (\$1,000,000.00) per occurrence and one million dollars (\$1,000,000.00) in the aggregate covering bodily injuries or property damage occurring on the Tower.

(b) *During Construction/Installation.* During construction/installation, Licensee's contractor shall also maintain and provide Village with evidence of each of the insurance coverages specified in subparagraph (a) and in the amounts so specified. In addition, the contractor shall provide builder's risk insurance on an "all risks" basis for one hundred percent (100%) of the insurable value of all construction work in place or in progress from time to time, insuring the project, including materials in storage and while in transit, against loss or damage by fire or other casualty, with extended coverage, vandalism and malicious mischief coverage, bearing a replacement cost agreed amount endorsement.

(c) *Policies.* The policy or policies of insurance required by subparagraphs (a) and (b) shall be underwritten by a company or companies authorized to do business in the State of Illinois, shall be reasonably satisfactory to Village, shall name Village as an additional insured and shall be delivered to the Village, together with evidence of the payment of the premiums, therefore, prior to the commencement of the term of this Lease. Licensee or, where applicable, Licensee's contractors shall furnish Village with a written notice of any cancellation, reduction or modification of insurance required under this Section.

(d) *Village's Insurance.* The Village shall be solely responsible for maintaining its

own fire and casualty insurance covering all of the Village's improvements, fixtures and personal property located on the Property.

15. **LIENS:** Licensee agrees that it will not permit or suffer any lien to be put upon or arise or accrue against the Property in favor of any person or persons, individual or corporate, furnishing either labor or material in any work herein proposed, and the Licensee further covenants and agrees to hold the Village and its property free from any and all liens, or rights or claim of lien, which may or might arise or accrue under or be based upon any mechanic's lien law of the State of Illinois. If any such lien or claim for lien is filed or recorded against the Property, the Village shall give Licensee notice thereof and demand that Licensee remove the same, or post adequate security to insure the removal of the same following the resolution of any dispute between Licensee and the lienholder, within thirty (30) days after such notice. Nothing in this provision shall restrict Licensee from granting a security interest in all or any part of the Licensee Improvements and to file of record UCC financing statement and/or fixture filings to perfect the same.

16. **ASSIGNMENT:** Licensee shall have the rights to sublicense or assign all or any part of its rights under this Agreement to any of its subsidiaries and affiliates or to any subsidiary or affiliate of Sprint Corporation (the "Permitted Assignees") without consent of the Village provided that the Village is given notice of the sublicense or assignment within 14 days thereof. Except as set forth in the preceding sentence, this Agreement may not be assigned or transferred without the express written consent of the Village, which shall not be unreasonably withheld, conditioned or delayed. Any assignment or transfer (other than to a Permitted Assignee) without such written consent shall, at the option of the Village, be deemed to be void and of no effect.

17. **HAZARDOUS SUBSTANCES:**

(a) The Village represents and warrants that it has no knowledge of any hazardous substance existing on the Property in violation of any applicable federal, state or local law, regulation or ordinance. The Village further agrees to hold Licensee harmless from and indemnify Licensee against any damage, loss or expense or liability resulting from the existence on the Property of any such hazardous substance, including all attorney's fees and consultant fees, costs and penalties, incurred as a result thereof, unless caused by Licensee or any of its employees or agents.

(b) Licensee represents and warrants that its use of the Licensed Premises will not generate any hazardous substance, and that it will not store or dispose on the Licensed Premises, nor transport to or over the Licensed Premises, any hazardous substance in violation of any applicable federal, state or local law, regulation or ordinance. Licensee further agrees to hold the Village harmless from and against and indemnify the Village against any release of such hazardous substance and any damage, loss, or expense or liability resulting from such release, including attorney's fees and consultant fees, costs and penalties, incurred as a result thereof, which was caused by Licensee or any of its employees or agents.

(c) "Hazardous substance" as used herein shall mean any substance or material defined

or designated as hazardous or toxic waste, hazardous or toxic materials, hazardous or toxic radioactive substance, or other similar term by any federal, state or local environmental law, regulation or ordinance presently in effect or promulgated in the future.

18. **COST OF ENFORCEMENT:** The prevailing party in any action or proceeding in court or mutually agreed upon arbitration proceeding to enforce the terms of this Agreement shall be entitled to receive its reasonable attorney's fees and other reasonable enforcement costs and expenses from the non-prevailing party.

19 **INVALIDITY:** If any section, paragraph, clause or provision of this Agreement shall be held invalid, the invalidity of such section, paragraph, clause or provision shall not affect any of the other provisions of this Agreement.

20. **FORCE MAJEURE:** Neither party shall be deemed in violation of this Agreement for the delay in performance or failure to perform in whole or in part its obligations under this Agreement due to strike, war or act of war (whether an actual declaration is made or not), insurrection, riot, act of public enemy, fire, flood or other act of God or by other events to the extent that such events are caused by circumstances beyond such party's control.

21. **NOTICES:** Unless otherwise specified herein, all notices under this agreement shall be made in writing and delivered to:

Village Manager
Village of Downers Grove
Civic Center
801 Burlington Avenue
Downers Grove, IL 60515-4776

SprintCom, Inc.
Attn: Director Network Real Estate
1200 Main Street
Kansas City, Missouri 64105

With copy to:

Sprint Spectrum L.P.
Attn: Area Manager
9801 Higgins Road, Suite 370
Rosemont, IL 60018

22. **GOVERNING LAW:** This Agreement shall be governed by the laws of the State of Illinois.

IN WITNESS WHEREOF, the parties hereto have executed this Agreement on the
6 day of July, 1998.

LICENSEE:

SPRINTCOM, INC.

By: James J. Meyers

Title: Area Manager

Subscribed and sworn to
this 2nd day of June, 1998.

Kelly L. Sinkler
Notary Public

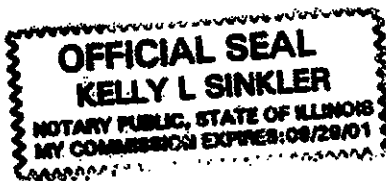

VILLAGE OF DOWNERS GROVE

By: Betty M. Cheever
Mayor

ATTEST:

Annell H. Hall
Village Clerk

LICENSE AGREEMENT BETWEEN THE VILLAGE OF DOWNERS GROVE AND SPRINTCOM, INC. TO INSTALL, MAINTAIN AND OPERATE ANTENNA EQUIPMENT ON VILLAGE PROPERTY

WITNESSETH

WHEREAS, the Village of Downers Grove (hereinafter referred to as the "Village") is an Illinois municipal corporation and a home rule unit, pursuant to the laws of the State of Illinois; and

WHEREAS, the Village is the owner of certain real estate located at 5235 Katrine, Downers Grove, Illinois (hereinafter referred to as the "Property"); and

WHEREAS, the Village previously granted a license to Smart SMR of Illinois, Inc. d/b/a Nextel Communications to install, maintain and operate an antenna tower on the Property; and

WHEREAS, the license agreement allows Nextel Communications, upon written consent of the Village, to sublease space on the antenna tower to other entities for telecommunications uses; and

WHEREAS, SprintCom, Inc. has requested that Nextel Communications sublease space to it on the antenna tower for installation, maintenance and operation of an antenna and the Village has provided written consent to this sublease; and

WHEREAS, SprintCom, Inc. has also requested use of a 20 by 24 foot portion of the Property for installation of a concrete slab that will hold four cabinets to house the related antenna equipment,

NOW, THEREFORE, in consideration of the mutual promises, covenants and conditions, the Village and SprintCom, Inc., a Kansas corporation (hereinafter referred to as "Licensee") agree as follows:

1. **CONTRACT DOCUMENTS:** The provisions set forth in the preamble and the following exhibits are incorporated into and made a part of this Agreement:

a. Exhibit 1 - Site map of the Property titled "SR638 B Katrine Avenue Nextel Co-Location - Site Plan Elevations-Sheet A-1," dated 5/14, 1998, and approved by the Village on 5/14, 1998, as marked and amended, showing the 20 by 24 foot area, together with the areas on the Property licensed to Licensee to provide access and utility service to such 20 by 24 foot area (collectively the "Licensed Premises").

b. Exhibit 2 - Plans and specifications titled "SR638 B Katrine Avenue Nextel Co-Location - Sheets A-2, S-1, EG-1," dated 5/14, 1998, and approved by the Village on 5/14, 1998, for any cables as marked and amended, or utility lines to be installed on the Licensed Premises and the equipment cabinets to be installed on the Licensed Premises and used for housing of the related antenna equipment (collectively the "Licensee Improvements").

During the term of this Agreement, there shall be no variations, modifications, or upgrades from the plans and specifications of Exhibits 1 and 2 without the prior written approval of the Village, which shall not be unreasonably withheld, conditioned or delayed.

2. **PROPERTY TO BE LEASED:** The Village hereby agrees to allow Licensee to use the Licensed Premises, as shown in Exhibit 1, for the installation, operation and maintenance of the Licensee Improvements and various antenna related equipment. The Licensed Premises shall be used by the Licensee only for the provision of telecommunications services.

3. **CONSTRUCTION, INSTALLATION AND MAINTENANCE:** Licensee shall comply with the following conditions:

- a. Licensee shall obtain all required permits and authorizations from the Village, in accordance with the applicable ordinances, prior to commencing any work under this Agreement. Such work shall comply with applicable codes and regulations and shall be conducted in a workmanlike manner.
- b. Licensee shall obtain all necessary approvals from any regulatory authorities for the operation of the Licensee Improvements. Further, Licensee shall comply with all applicable laws and regulations of such regulatory authorities including, but not limited to the Federal Communications Commission.
- c. All costs connected with the installation, maintenance, repair, use and removal of the Licensee Improvements shall be the responsibility of the Licensee.
- d. Licensee shall not take any action or allow any action to be done which may impair the use of or damage Village property.
- e. Licensee may not interfere with the use by the Village, its officers, agents and employees, of the Property.
- f. Licensee shall be entitled to access the Licensed Premises twenty-four (24) hours a day, seven days a week. Except for emergency situations, Licensee shall provide Village reasonable advance notice before beginning any work or maintenance on the Licensee Improvement. In the event of an emergency, if prior notice is not possible, the Licensee shall provide notice at the earliest reasonable opportunity.
- g. The Licensee shall maintain the Licensed Premises in good repair, and in a clean and sightly condition.
- h. Upon termination of this Agreement by either party, the Licensee shall, within thirty (30) days and at its expense, remove the Licensee Improvements and restore the Licensed Premises to substantially its original condition, reasonable wear and tear and casualty loss excepted.

i. If Licensee abandons its use of the Licensee Improvements, Licensee shall, within thirty (30) days of receipt of written notice from the Village notifying the Licensee of such abandonment and at its expense, remove the Licensee Improvements and restore the Licensed Premises to substantially its original condition. Licensee Improvements will be presumed abandoned if they are not operated for a period of one month or more. If the Licensee Improvements are not removed within thirty (30) days, the Village may remove the Licensee Improvements and the Licensee shall reimburse the Village for the costs of such removal.

4. **NON-INTERFERENCE WITH VILLAGE OPERATIONS:** Neither this lease nor the Licensee Improvements nor any antenna installed by Licensee on the Nextel Communications tower shall interfere or obstruct the functioning of the Village's operations and services. Licensee warrants that the Licensee Improvements and the antenna installed on the Nextel Communications tower shall be constructed, installed, maintained and operated in such a manner as to not interfere or obstruct any radio or electronic equipment or signals of the Village's radio and data systems. In the event such interference occurs, and the interference cannot be eliminated by Licensee after reasonable efforts, the Village may terminate this Agreement. Provided after notice to Licensee, the Village may immediately terminate this Agreement, or require that operation of the antenna be immediately ceased where it determines that the antenna presents an immediate and serious danger to the public health, welfare or safety due to interference with the operation of the Village's radio and data systems.

5. **TERM:**

(a) Unless extended pursuant to Paragraph 5(b), this License shall have an Initial Term beginning September 1, 1998 or upon receipt of a building permit, whichever occurs first (the "Commencement Date") and ending August 31, 2003, and two (2) five-year Extension Terms beginning September 1, 2003, and September 1, 2008, respectively. The first Extension Term beginning September 1, 2003 shall automatically commence. The second Extension Term beginning September 1, 2008, shall automatically commence unless either party provides the other party with written notice of its election not to renew the License at least one hundred and twenty (120) days prior to the expiration of the current term.

(b) After June 1, 2013, Licensee may request the Village to enter into negotiations towards renewing or extending this Agreement beyond August 31, 2013. Such renewal or extension shall be according to terms that are mutually agreeable and the Village shall not be bound to accept any particular terms or to renew any or all of the rights granted by this Agreement.

6. **COMPENSATION:** Beginning on the Commencement Date of this Agreement, Licensee shall pay to the Village the sum of \$1,500.00 per month as rent for the first year of the Agreement. Thereafter, effective on each annual anniversary of the Commencement Date, the monthly rental fee shall increase in an amount equal to the fee for the preceding year multiplied by 1.04 (104%). The amount shall be prorated for any fractional month at the beginning or at the end of a term. The rental fee shall be paid to the Village of Downers Grove, Village Hall, 801 Burlington Avenue, Downers Grove, IL 60515.

7. **TERMINATION**: This Agreement may be terminated as follows:

(a) After the Commencement Date, Licensee may terminate this Agreement at any time upon sixty (60) days written notice to the Village without further liability if Licensee does not obtain all permits or other approvals required from any governmental authority or any easements required from any third part to operate the PCS system, or if any such approval is canceled, expires or is withdrawn or terminated, or if Licensor fails to have proper ownership of the site or authority to enter into this Agreement, or if Licensee, for any other reason, in its sole discretion, determines that it will be unable to use the Property, however, if Licensee terminates this Agreement without cause, it shall pay the Village a termination penalty equal to three months of the current rental amount.

(b) In the event either party fails to comply with the terms of this Agreement such party shall be considered in default and the non-defaulting party may serve written notice of its intent to terminate the Agreement. Except where the public health or safety is threatened, the notice shall give the defaulting party not less than thirty (30) days to correct such non-compliance. In the event the default is not corrected within thirty (30) days of such notice, the non-defaulting party may terminate this Agreement by serving a written notice of termination. Notwithstanding the preceding, if any default cannot be cured within thirty (30) days and the defaulting party has diligently commenced and continues to take reasonable action necessary to cure the default, the defaulting party shall be entitled to an extended reasonable period of time in order to complete the cure.

8. **RESTORATION**: When the Licensee does any work on or affecting the Licensed Premises, it shall, at its own expense, restore the Licensed Premises to as good a condition as existed before the work was undertaken, unless otherwise directed by the Village. If the Licensee fails to restore the Licensed Premises, the Village may, after communications with the Licensee and after affording the Licensee a reasonable opportunity to correct the situation, restore the leased area and remove any obstructions therefrom. No such prior written notice shall be required in the event that the Village determines that an emergency situation exists. The Licensee shall pay the Village for any reasonable costs of such restoration within thirty (30) days after receiving a bill from the Village for such work.

9. **UTILITIES**: Licensee shall be responsible for obtaining adequate utilities for operation of the Licensee Improvements including electricity. Any utilities to be installed must be underground and the location approved by the Village. Licensee shall pay for the electricity or any other utility it consumes in its operations at the rate charged by the servicing utility company and the Village shall not be liable for such charges.

10. **TAXES**: Licensee shall either pay, or reimburse the Village, for any personal or real property taxes which are assessed as a result of the Licensee Improvements and use of the Licensed Premises under the terms of this Agreement. The Village shall provide to Licensee all assessment notices or tax bills received by the Village from any applicable taxing authority, within thirty (30) days after the Village's receipt of the same, but in no event later than fifteen (15) days prior to the deadline date for the filing of any objection or protest thereto. Licensee shall have the right, at its own expense and without expense to the Village, to contest by

appropriate proceedings, conducted with due diligence and in good faith, the validity of the amount of any taxes or reassessment as applicable to the Licensed Premises or the Licensee Improvements.

11. **INDEMNIFICATION:**

(a) Licensee shall indemnify, become responsible for and save harmless the Village, its boards, committees, commissions, officers, agents and employees from any and all liability arising out of the existence of this Agreement; the installation, existence, maintenance or repair of the antenna and its related equipment; or any act or omission of Licensee, its officers, agents and employees.

(b) The Village shall indemnify, become responsible for and save harmless Licensee, its officers, agents and employees from any and all liability arising out of the Village's ownership and use of the Property or any act or omission of the Village, its officers, agents and employees.

(c) For purposes of this Agreement, the term "liability" includes, but is not limited to: actual or claimed loss or damage to property or injury to or death of persons; actual or claimed responsibility for such loss, damage, injury or death; and any and all judgments, decrees, costs and expenses of every sort and kind incident to such loss, damage, injury, death or responsibility, including, but not limited to, court costs, fines and attorney's fees.

12. **INSURANCE:** At all times while this Agreement remains in effect, and in recognition of the indemnification provided in the foregoing Paragraph 11, the Licensee shall, at its own cost and expense, maintain a program of third party liability insurance and/or self-insurance to protect the Village, its officers, employees and agents from any liability for bodily injury, death, and property damage occasioned by the activities of the Licensee under this Agreement, as follows:

(a) *During the Term of the Agreement.* Licensee shall procure, pay for and maintain in full force and effect during the entire term of the Agreement (i) worker's compensation insurance as required by law and which insures Village against worker's compensation claims arising out of Licensee's activities; (ii) fire and casualty insurance covering the Licensee Improvements in an amount not less than one hundred percent (100%) of their actual replacement cost; and (iii) commercial general liability insurance, including broad form property damage insurance, for bodily injuries and property damage, in amounts not less than one million dollars (\$1,000,000.00) per occurrence and one million dollars (\$1,000,000.00) in the aggregate covering bodily injuries or property damage.

(b) *During Construction/Installation.* During construction/installation, Licensee's contractor shall also maintain and provide Village with evidence of each of the insurance coverages specified in subparagraph (a) and in the amounts so specified. In addition, the contractor shall provide builder's risk insurance on an "all risks" basis for one hundred percent (100%) of the

insurable value of all construction work in place or in progress from time to time, insuring the project, including materials in storage and while in transit, against loss or damage by fire or other casualty, with extended coverage,

vandalism and malicious mischief coverage, bearing a replacement cost agreed amount endorsement.

(c) *Policies.* The policy or policies of insurance required by subparagraphs (a) and (b) shall be underwritten by a company or companies authorized to do business in the State of Illinois, shall be reasonably satisfactory to Village, shall name Village as an additional insured and shall be delivered to the Village, together with evidence of the payment of the premiums, therefore, prior to the commencement of the term of this Lease. Licensee or, where applicable, Licensee's contractors shall furnish Village with a written notice of any cancellation, reduction or modification of insurance required under this Section.

(d) *Village's Insurance.* The Village shall be solely responsible for maintaining its own fire and casualty insurance covering all of the Village's improvements, fixtures and personal property located on the Property.

13. **LIENS:** Licensee agrees that it will not permit or suffer any lien to be put upon or arise or accrue against the leased property in favor of any person or persons, individual or corporate, furnishing either labor or material in any work herein proposed, and the Licensee further covenants and agrees to hold the Village and its property free from any and all liens, or rights or claim of lien, which may or might arise or accrue under or be based upon any mechanic's lien law of the State of Illinois. If any such lien or claim for lien is filed or recorded against the Property, the Village shall give Licensee notice thereof and demand that Licensee remove the same, or post adequate security to insure the removal of the same following the resolution of any dispute between Licensee and the lienholder, within thirty (30) days after such notice. Nothing in this provision shall restrict Licensee from granting a security interest in all or any part of the Licensee Improvements and to file of record UCC financing statement and/or fixture filings to perfect the same.

14. **ASSIGNMENT:** Licensee shall have the right to sublicense or assign all or any part of its rights under this Agreement to any of its subsidiaries and affiliates or to any subsidiary or affiliate of Sprint Corporation (the "Permitted Assignees") without consent of the Village provided that the Village is given notice of the sublicense or assignment within 14 days thereof. Except as set forth in the preceding sentence, this Agreement may not be assigned or transferred without the express written consent of the Village, which shall not be unreasonably withheld, conditioned or delayed. Any assignment or transfer (other than to a Permitted Assignee) without such written consent shall, at the option of the Village, be deemed to be void and of no effect.

15. **HAZARDOUS SUBSTANCES:**

(a) The Village represents and warrants that it has no knowledge of any hazardous substance existing on the Property in violation of any applicable federal, state or local law,

regulation or ordinance. The Village further agrees to hold Licensee harmless from and indemnify Licensee against any damage, loss or expense or liability resulting from the existence on the Property of any such hazardous substance, including all attorney's fees and

consultant fees, costs and penalties, incurred as a result thereof, unless caused by Licensee or any of its employees or agents.

(b) Licensee represents and warrants that its use of the Licensed Premises will not generate any hazardous substance, and that it will not store or dispose on the Licensed Premises, nor transport to or over the Licensed Premises, any hazardous substance in violation of any applicable federal, state or local law, regulation or ordinance. Licensee further agrees to hold the Village harmless from and against and indemnify the Village against any release of such hazardous substance and any damage, loss, or expense or liability resulting from such release, including attorney's fees and consultants fees, costs and penalties, incurred as a result thereof, which was caused by Licensee or any of its employees or agents.

(c) "Hazardous substance" as used herein shall mean any substance or material defined or designated as hazardous or toxic waste, hazardous or toxic material, hazardous or toxic radioactive substance, or other similar term by any federal, state or local environmental law, regulation or ordinance presently in effect or promulgated in the future.

16. **COST OF ENFORCEMENT:** The prevailing party in any action or proceeding in court or mutually agreed upon arbitration proceeding to enforce the terms of this Agreement shall be entitled to receive its reasonable attorney's fees and other reasonable enforcement costs and expenses from the non-prevailing party.

17. **INVALIDITY:** If any section, paragraph, clause or provision of this Agreement shall be held invalid, the invalidity of such section, paragraph, clause or provision shall not affect any of the other provisions of this Agreement.

18. **FORCE MAJEURE:** Neither party shall be deemed in violation of this Agreement for the delay in performance or failure to perform in whole or in part its obligations under this Agreement due to strike, war or act of war (whether an actual declaration is made or not), insurrection, riot, act of public enemy, fire, flood or other act of God or by other events to the extent that such events are caused by circumstances beyond such party's control.

19. **NOTICES:** Unless otherwise specified herein, all notices under this agreement shall be made in writing and delivered to:

Village Manager
 Village of Downers Grove
 Civic Center
 801 Burlington Avenue
 Downers Grove, IL 60515-4776

SprintCom, Inc.
Attn.: Director Network Real Estate
1200 Main Street
Kansas City, Missouri 64105

With copy to:

Sprint Spectrum LP
Attn.: Area Manager
9801 Higgins Road, Suite 370
Rosemont, IL 60018

20. **GOVERNING LAW:** This Agreement shall be governed by the laws of the State of Illinois.

IN WITNESS WHEREOF, the parties hereto have executed this Agreement on the 6 day of July, 1998.

LICENSEE

SPRINTCOM, INC.

By: James J. Mayers
Title: Area Manager



Subscribed and sworn to
this 7th day of July, 1998

Kelly L. Sinkler
Notary Public

VILLAGE OF DOWNERS GROVE

By: Betty M. Cheever
Mayor

ATTEST:

April N. Hill
Village Clerk

LICENSE AGREEMENT BETWEEN THE VILLAGE OF DOWNERS GROVE AND SPRINTCOM, INC. TO INSTALL, MAINTAIN AND OPERATE ANTENNA EQUIPMENT ON VILLAGE PROPERTY

WITNESSETH

WHEREAS, the Village of Downers Grove (hereinafter referred to as the "Village") is an Illinois municipal corporation and a home rule unit, pursuant to the laws of the State of Illinois; and

WHEREAS, the Village is the owner of certain real estate located at 4318 Downers Drive, Downers Grove, Illinois, upon which is located a Village water tower known as the Downers Drive Tower (hereinafter referred to as the "Tower"); and

WHEREAS, SprintCom, Inc., a Kansas Corporation (hereinafter referred to as the "Licensee") has requested permission to install communications antennae and related equipment (hereinafter referred to as the "Antenna") on the top of the Tower (the "Tower Space") and certain related equipment in cabinets on the ground (the "Ground Space"); and

NOW, THEREFORE, in consideration of the mutual promises, covenants and conditions, the Village and the Licensee agree as follows:

1. **CONTRACT DOCUMENTS:** The provisions set forth in the preamble and the following exhibits are incorporated into and made a part of this Agreement by reference:

a. Exhibit 1 - Site map of the Property titled "^{649c Downers Drive Water Tower - Site & Eq.}Plan - Sheet A-1," dated ^{5/10}~~Cover sheet~~, 1998, and approved by the Village on 6/11, 1998, as marked and showing the Tower Space and the Ground Space, together with the areas on the ^{amended,} Property licensed to Licensee to provide access and utility service to the Ground Space (collectively the "Licensed Premises") which includes location of any proposed underground utilities necessary for operation of the Antenna.

b. Exhibit 2 - Plans and specifications titled "^{649c Downers Drive Water Tower - Sheets}A2 to A4 & E1 to E3," dated ^{5/10}~~Cover sheet~~, 1998, and approved by the Village on 6/11, 1998, ^{as marked and amended,} for the Antenna and any cables or utility lines to be installed on the Licensed Premises and the equipment cabinets to be installed on the Licensed Premises and used for housing of the related Antenna equipment (collectively the "Licensee Improvements").

2. **GRANT OF LICENSE:** The Village hereby grants to the Licensee the license, right, permission and authority to install, operate and maintain the Licensed Improvements upon the terms and conditions hereinafter specified. The license shall not terminate upon the sale, assignment or transfer of the property, but shall run with the land.

3. **SPECIFICATIONS:** The Licensee shall comply with the following specifications:

- a. *In general:* During the term of this agreement, there shall be no variations, modifications, or upgrades from the plans and specifications of Exhibits 1 and 2 without the prior written approval of the Village, which shall not be unreasonably withheld, conditioned or delayed.
- b. *Antenna:* The Antenna shall be for the operation of radio frequency: receive 1865-1870 & 1885-1990; transmit 1945-1950 & 1965-1970. The Antenna shall be installed, attached to the Tower, and maintained in conformance with Exhibit 2 and any applicable state of federal requirements. The Antenna shall be located more than ten (10) feet from any existing antenna equipment and shall not exceed sixty (60) inches in height.

4. **CONSTRUCTION, INSTALLATION AND MAINTENANCE:** The Licensee may install, repair, maintain, or replace the Antenna, subject to the following conditions:

- a. Licensee shall obtain all required permits and authorizations from the Village, in accordance with the applicable ordinances, prior to commencing any work under this agreement. Such work shall comply with applicable codes and regulations and shall be conducted in a workmanlike manner.
- b. The Licensee shall obtain all necessary approvals from any regulatory authorities for the operation of the Licensee Improvements. Further, the Licensee shall comply with all applicable laws and regulations of such regulatory authorities including, but not limited to, the Federal Communications Commission.
- c. All costs connected with the installation, maintenance, repair, use and removal of the Licensee Improvements shall be the responsibility of the Licensee.
- d. The Licensee shall not take any action or allow any action to be done which may impair the use of or damage the Tower.
- e. The Licensee may not interfere with the use by the Village, its officers, agents and employees, of the Tower or the property on which it is located.
- f. Except for emergency situations, the Village shall provide reasonable advance notice to Licensee when it conducts any Tower repair or maintenance work that affects the Antenna or function of the Antenna or any of the Licensee Improvements.
- g. Licensee shall be entitled to access the equipment located on the Ground Space twenty-four (24) hours a day, seven days a week. Licensee shall provide Village reasonable advance notice when access to the Tower Space is needed. Keys to the Tower can only be obtained between the hours of 8:00 a.m. and 4:00 p.m. from the Village Operations Center, or in the event of an emergency after hours, by calling (630) 434-5706 or 5707.

h. The Licensee shall maintain the Licensed Premises in good repair, and in a clean and sightly condition.

i. Upon termination of this Agreement by either party, the Licensee shall, within thirty (30) days and at its expense, remove the Licensee Improvements and restore the Licensed Premises to substantially its original condition, reasonable wear and tear and casualty loss excepted.

j. If Licensee abandons its use of the Antenna, Licensee shall, within thirty (30) days of receipt of written notice from the Village notifying the Licensee of such abandonment and at its expense, remove the Licensee Improvements and restore the Licensed Premises to substantially its original condition. Licensee Improvements will be presumed abandoned if it is not operated for a period of one month or more. If the Licensee Improvements are not removed within thirty (30) days, the Village may remove the Licensee Improvements and the Licensee shall reimburse the Village for the costs of such removal.

5. **NON-INTERFERENCE WITH VILLAGE OPERATIONS:** Neither this license nor the Licensee Improvements shall interfere or obstruct the functioning of the Village's operations and services. Licensee warrants that the Licensee Improvements shall be constructed, installed, maintained and operated in such a manner as to not interfere or obstruct any radio or electronic equipment or signals of the Village's radio and data systems. In the event such interference occurs, and the interference cannot be eliminated by Licensee after reasonable efforts, the Village may terminate this Agreement. Provided after notice to Licensee, the Village may immediately terminate this Agreement, or require that operation of the Antenna or any of the Licensee Improvements be immediately ceased where it determines that the Antenna or the Licensee Improvements present an immediate and serious danger to the public health, welfare or safety due to interference with the operation of the Village's radio and data systems.

6. **TERM:**

(a) Unless extended pursuant to Paragraph 5(b), this License shall have an Initial Term beginning September 1, 1998 or upon receipt of a building permit, whichever occurs first (the "Commencement Date") and ending August 31, 2003, and two (2) five-year Extension Terms beginning September 1, 2003, and September 1, 2008, respectively. The first Extension Term beginning September 1, 2003 shall automatically commence. The second Extension Term beginning September 1, 2008, shall automatically commence unless either party provides the other party with written notice of its election not to renew the License at least one hundred and twenty (120) days prior to the expiration of the current term.

(b) After June 1, 2013, Licensee may request the Village to enter into negotiations towards renewing or extending this Agreement beyond August 31, 2013. Such renewal or extension shall be according to terms that are mutually agreeable and the Village shall not be bound to accept any particular terms or to renew any or all of the rights granted by this Agreement.

7. **COMPENSATION:** Beginning on the Commencement Date, Licensee shall pay to the Village a license fee of \$2,250.00 per month for the first year of the Agreement. Thereafter, effective on each annual anniversary of the Commencement Date, the monthly license fee shall increase in an amount equal to the fee for the preceding year multiplied by 1.04 (104%). The amount shall be prorated for any fractional month at the beginning or at the end of a term. The fee shall be paid to the Village of Downers Grove, Village Hall, 801 Burlington Avenue, Downers Grove, IL 60515.

8. **TERMINATION:** This Agreement may be terminated as follows:

(a) After the Commencement Date, Licensee may terminate this Agreement at any time upon sixty (60) days written notice to the Village without further liability if Licensee does not obtain all permits or other approvals required from any governmental authority or any easements required from any third party to operate the PCS system, or if any such approval is canceled, expires or is withdrawn or terminated, or if Licensor fails to have proper ownership of the site or authority to enter into this Agreement, or if Licensee, for any other reason, in its sole discretion, determines that it will be unable to use the Property, however, if Licensee terminates this Agreement without cause, it shall pay the Village a termination penalty equal to three months of the current rental amount.

(b) In the event either party fails to comply with the terms of this Agreement such party shall be considered in default and the non-defaulting party may serve written notice of its intent to terminate the Agreement and the license. Except where the public health or safety is threatened, the notice shall give the defaulting party not less than thirty (30) days to correct such non-compliance. In the event the default is not corrected within thirty (30) days of such notice, the non-defaulting party may terminate this Agreement by serving a written notice of termination. Notwithstanding the preceding, if any default cannot be cured within thirty (30) days and the defaulting party has diligently commenced and continues to take reasonable action necessary to cure the default, the defaulting party shall be entitled to an extended reasonable period of time in order to complete the cure.

(c) In the event the Tower is destroyed or substantially damaged, this agreement shall be considered terminated.

9. **TOWER REPAIR/MAINTENANCE:** Upon receiving thirty (30) days notice from the Village that it intends to repair or perform maintenance to the Tower, Licensee shall, at its own expense and in such manner as the Village shall reasonably request, immediately remove, relocate, change or alter the position of the Antenna. During the term of this Agreement, the Tower may be refurbished and/or painted. Refurbishment and/or painting will take several months to complete (approximately five to eight months). Prior to beginning refurbishment and/or painting, Licensee understands that its Antenna shall be removed from the Tower upon notice from the Village and that the Antenna shall not be reinstalled until the refurbishment and/or painting is completed and the Village has approved such reinstallation. During such period, Licensee may, at its sole cost and expense, install the Antenna on a temporary telephone pole outside the shrouded area of the tower in a location approved by the Village. However, such temporary arrangement shall not interfere with the refurbishment and/or

painting of the tower or with other Village operations on the site. The Village shall not be responsible for any costs of removal, relocation, and reinstallation of the Antenna as a result of the refurbishment and/or painting.

10. **RESTORATION**: When the Licensee does any work on or affecting the Licensed Premises, it shall, at its own expense, restore the Licensed Premises to as good a condition as existed before the work was undertaken, unless otherwise directed by the Village. If the Licensee fails to restore the Licensed Premises, the Village may, after communications with the Licensee and after affording the Licensee a reasonable opportunity to correct the situation, restore the Licensed Premises and remove any obstruction therefrom. No such prior written notice shall be required in the event that the Village determines that an emergency situation exists. The Licensee shall pay the Village for any reasonable costs of such restoration within thirty (30) days after receiving a bill from the Village for such work.

11. **UTILITIES**: Licensee shall be responsible for obtaining adequate utilities for operation of the Licensee Improvements including electricity from any source available on the Property as long as the electricity for the Licensee Improvements are separately metered. Any utilities to be installed must be underground and the location approved by the Village. Licensee shall pay for the electricity or any other utility it consumes in its operations at the rate charged by the servicing utility company and the Village shall not be liable for such charges.

12. **TAXES**: Licensee shall either pay, or reimburse the Village, for any personal or real property taxes which are assessed as a result of the Licensee Improvements and use of the Licensed Premises under the terms of this Agreement. The Village shall provide to Licensee all assessment notices or tax bills received by the Village from any applicable taxing authority, within thirty (30) days after the Village's receipt of the same, but in no event later than fifteen (15) days prior to the deadline date for the filing of any objection or protest thereto. Licensee shall have the right, at its own expense and without expense to the Village, to contest by appropriate proceedings, conducted with due diligence and in good faith, the validity of the amount of any taxes or reassessment as applicable to the Licensed Premises or the Licensee Improvements.

13. **INDEMNIFICATION**:

(a) Licensee shall indemnify, become responsible for and save harmless the Village, its boards, committees, commissions, officers, agents and employees from any and all liability arising out of the existence of this Agreement; the installation, existence, maintenance or repair of the Licensee Improvements; or any act or omission of Licensee, its officers, agents and employees.

(b) The Village shall indemnify, become responsible for and save harmless Licensee, its officers, agents and employees from any and all liability arising out of the Village's ownership and use of the Property or any act or omission of the Village, its officers, agents and employees.

(c) For purposes of this Agreement, the term "liability" includes, but is not limited to: actual or claimed loss or damage to property or injury to or death of persons; actual or claimed responsibility for such loss, damage, injury or death; and any and all judgments, decrees, costs and expenses of every sort and kind of incident to such loss, damage, injury, death or responsibility, including, but not limited to, court costs, fines and attorney's fees.

14. **INSURANCE:** At all times while this Agreement remains in effect, and in recognition of the indemnification provided in the foregoing Paragraph 13, the Licensee shall, at its own cost and expense, maintain a program of third party liability insurance and/or self-insurance to protect the Village, its officers, employees and agents from any liability for bodily injury, death, and property damage occasioned by the activities of the Licensee under this Agreement, as follows:

(a) *During the Term of the Agreement.* Licensee shall procure, pay for and maintain in full force and effect during the entire term of the Agreement (i) worker's compensation insurance as required by law and which insures against worker's compensation claims arising out of Licensee's activities on the Tower; (ii) fire and casualty insurance covering the Licensee Improvements in an amount not less than one hundred percent (100%) of their actual replacement cost; and (iii) commercial general liability insurance, including broad form property damage insurance, for bodily injuries and property damage, in amounts not less than one million dollars (\$1,000,000.00) per occurrence and one million dollars (\$1,000,000.00) in the aggregate covering bodily injuries or property damage occurring on the Tower.

(b) *During Construction/Installation.* During construction/installation, Licensee's contractor shall also maintain and provide Village with evidence of each of the insurance coverages specified in subparagraph (a) and in the amounts so specified. In addition, the contractor shall provide builder's risk insurance on an "all risks" basis for one hundred percent (100%) of the insurable value of all construction work in place or in progress from time to time, insuring the project, including materials in storage and while in transit, against loss or damage by fire or other casualty, with extended coverage, vandalism and malicious mischief coverage, bearing a replacement cost agreed amount endorsement.

(c) *Policies.* The policy or policies of insurance required by subparagraphs (a) and (b) shall be underwritten by a company or companies authorized to do business in the State of Illinois, shall be reasonably satisfactory to Village, shall name Village as an additional insured and shall be delivered to the Village, together with evidence of the payment of the premiums, therefore, prior to the commencement of the term of this Lease. Licensee or, where applicable, Licensee's contractors shall furnish Village with a written notice of any cancellation, reduction or modification of insurance required under this Section.

(d) *Village's Insurance.* The Village shall be solely responsible for maintaining its

own fire and casualty insurance covering all of the Village's improvements, fixtures and personal property located on the Property.

15. **LIENS:** Licensee agrees that it will not permit or suffer any lien to be put upon or arise or accrue against the Property in favor of any person or persons, individual or corporate, furnishing either labor or material in any work herein proposed, and the Licensee further covenants and agrees to hold the Village and its property free from any and all liens, or rights or claim of lien, which may or might arise or accrue under or be based upon any mechanic's lien law of the State of Illinois. If any such lien or claim for lien is filed or recorded against the Property, the Village shall give Licensee notice thereof and demand that Licensee remove the same, or post adequate security to insure the removal of the same following the resolution of any dispute between Licensee and the lienholder, within thirty (30) days after such notice. Nothing in this provision shall restrict Licensee from granting a security interest in all or any part of the Licensee Improvements and to file of record UCC financing statement and/or fixture filings to perfect the same.

16. **ASSIGNMENT:** Licensee shall have the rights to sublicense or assign all or any part of its rights under this Agreement to any of its subsidiaries and affiliates or to any subsidiary or affiliate of Sprint Corporation (the "Permitted Assignees") without consent of the Village provided that the Village is given notice of the sublicense or assignment within 14 days thereof. Except as set forth in the preceding sentence, this Agreement may not be assigned or transferred without the express written consent of the Village, which shall not be unreasonably withheld, conditioned or delayed. Any assignment or transfer (other than to a Permitted Assignee) without such written consent shall, at the option of the Village, be deemed to be void and of no effect.

17. **HAZARDOUS SUBSTANCES:**

(a) The Village represents and warrants that it has no knowledge of any hazardous substance existing on the Property in violation of any applicable federal, state or local law, regulation or ordinance. The Village further agrees to hold Licensee harmless from and indemnify Licensee against any damage, loss or expense or liability resulting from the existence on the Property of any such hazardous substance, including all attorney's fees and consultant fees, costs and penalties, incurred as a result thereof, unless caused by Licensee or any of its employees or agents.

(b) Licensee represents and warrants that its use of the Licensed Premises will not generate any hazardous substance, and that it will not store or dispose on the Licensed Premises, nor transport to or over the Licensed Premises, any hazardous substance in violation of any applicable federal, state or local law, regulation or ordinance. Licensee further agrees to hold the Village harmless from and against and indemnify the Village against any release of such hazardous substance and any damage, loss, or expense or liability resulting from such release, including attorney's fees and consultant fees, costs and penalties, incurred as a result thereof, which was caused by Licensee or any of its employees or agents.

(c) "Hazardous substance" as used herein shall mean any substance or material defined

or designated as hazardous or toxic waste, hazardous or toxic materials, hazardous or toxic radioactive substance, or other similar term by any federal, state or local environmental law, regulation or ordinance presently in effect or promulgated in the future.

18. **COST OF ENFORCEMENT:** The prevailing party in any action or proceeding in court or mutually agreed upon arbitration proceeding to enforce the terms of this Agreement shall be entitled to receive its reasonable attorney's fees and other reasonable enforcement costs and expenses from the non-prevailing party.

19. **INVALIDITY:** If any section, paragraph, clause or provision of this Agreement shall be held invalid, the invalidity of such section, paragraph, clause or provision shall not affect any of the other provisions of this Agreement.

20. **FORCE MAJEURE:** Neither party shall be deemed in violation of this Agreement for the delay in performance or failure to perform in whole or in part its obligations under this Agreement due to strike, war or act of war (whether an actual declaration is made or not), insurrection, riot, act of public enemy, fire, flood or other act of God or by other events to the extent that such events are caused by circumstances beyond such party's control.

21. **NOTICES:** Unless otherwise specified herein, all notices under this agreement shall be made in writing and delivered to:

Village Manager
Village of Downers Grove
Civic Center
801 Burlington Avenue
Downers Grove, IL 60515-4776

SprintCom, Inc.
Attn: Director Network Real Estate
1200 Main Street
Kansas City, Missouri 64105

With copy to:

Sprint Spectrum L.P.
Attn: Area Manager
9801 Higgins Road, Suite 370
Rosemont, IL 60018

22. **GOVERNING LAW:** This Agreement shall be governed by the laws of the State of Illinois.

98-38

IN WITNESS WHEREOF, the parties hereto have executed this Agreement on the 6 day of July, 1998.



LICENSEE:

SPRINTCOM, INC

By: James J. Meyers

Title: Area Manager

Subscribed and sworn to this 7th day of June 1998.

Kelly L Sinkler
Notary Public

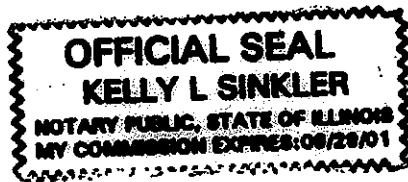

VILLAGE OF DOWNERS GROVE

By: Betty M. Cheever
Mayor

ATTEST:

April K. Holt
Village Clerk

RESOLUTION NO. 2009-86**A RESOLUTION AUTHORIZING EXECUTION OF A FIRST AMENDMENT TO LICENSE AGREEMENT BETWEEN THE VILLAGE OF DOWNERS GROVE AND SPRINTCOM, INC. TO INSTALL, MAINTAIN AND OPERATE ANTENNA EQUIPMENT ON VILLAGE PROPERTY**

BE IT RESOLVED by the Village Council of the Village of Downers Grove, DuPage County, Illinois as follows:

1. That the form and substance of a certain First Amendment ("Amendment No. 1"), between the between the Village of Downers Grove ("Landlord") and SprintCom, Inc. ("Tenant") for a license agreement to install, maintain and operate antenna equipment on Village property located at 4414 Downers Drive, Downers Grove, IL, as set forth in Amendment No. 1 submitted to this meeting with the recommendation of the Village Manager, is hereby approved.
2. That the Village Manager and Village Clerk are hereby respectively authorized and directed for and on behalf of the Village to execute, attest, seal and deliver Amendment No. 1, substantially in the form approved in the foregoing paragraph of this Resolution, together with such changes as the Manager shall deem necessary.
3. That the proper officials, agents and employees of the Village are hereby authorized and directed to take such further action as they may deem necessary or appropriate to perform all obligations and commitments of the Village in accordance with the provisions of the Amendment No. 1.
4. That all resolutions or parts of resolutions in conflict with the provision of this Resolution are hereby repealed.
5. That this Resolution shall be in full force and effect from and after its passage as provided by law.

Mayor

Passed: September 15, 2009
Attest: Donna L. Mc
Village Clerk

Premises Name: Downers Grove

Premises ID #: CH03XC649

AMENDMENT NO. I TO LICENSE AGREEMENT BETWEEN THE VILLAGE OF DOWNERS GROVE AND SPRINTCOM, INC. TO INSTALL, MAINTAIN AND OPERATE ANTENNA EQUIPMENT ON VILLAGE PROPERTY

This Amendment No. I to License Agreement between the Village of Downers Grove and Sprintcom, Inc. to Install, Maintain and Operate Antenna Equipment on Village Property ("Amendment"), effective as of the date last signed below ("Effective Date"), amends a certain License Agreement by and between Sprintcom, Inc, a Kansas corporation ("Licensee") and the Village of Downers Grove, an Illinois municipal corporation ("Village"), dated July 6, 1998, (the "Agreement").

BACKGROUND

Licensee desires to allow its affiliates or joint venture partners to use some portion of the Licensed Premises for the deployment of advanced wireless services.

Licensee and the Village therefore desire to modify the provisions of the Agreement as provided below.

AGREEMENT

For good and valuable consideration the receipt and sufficiency of which is acknowledged, the Village and Licensee agree as follows:

1. **Modification to the Licensee Improvements.** Exhibit 2 of the Agreement is amended to include the revised Exhibit 2.2, consisting of lease drawings labeled C-2 and C-4, a copy of which is attached and made a part hereof. Upon full execution of this Amendment, Licensee is permitted to do all work necessary to prepare, maintain and alter the Licensed Premises to install, modify or otherwise relocate the Licensee Improvements, all as more fully described and contemplated in Exhibit 2.2.
2. **Assignment and Subletting.** Section 16 of the Agreement shall remain as is.
3. **Expiration or Termination of Sublicense.** If Licensee's sublicensee (i) does not install, construct or add equipment to the Licensed Premises, or (ii) installs equipment, but later removes the equipment, then upon written notice to Village, Licensee may terminate this Amendment. After terminating the Amendment, the terms and conditions of the Agreement as they existed immediately prior to the Effective Date of this Amendment shall be deemed ratified, and shall continue in full force and effect. Rent shall revert to the amount in effect immediately prior to the Effective Date of this Amendment, plus any rental increases, including annual escalators or rent increases due to other Licensed Premises modifications made by Licensee, which occurred during the period of time between the Effective Date of this Amendment and the termination date of this Amendment.
4. **Modification to Rent.** In consideration for the revisions contemplated by this Amendment, effective upon the first day of the month following the date the Licensee Improvements are modified, the monthly rent will be increased by \$500.00.

[Handwritten signature]

5. Licensee's Notice Address. Licensee's notice address in Section 21 of the Agreement is hereby deleted in its entirety and replaced with the following:

Sprint/Nextel Property Services
Mailstop KSOPHT0101-Z2650
6391 Sprint Parkway
Overland Park, Kansas 66251-2650

With a mandatory copy to:

Sprint/Nextel Law Department
Mailstop KSOPHT0101-Z2020
6391 Sprint Parkway
Overland Park, Kansas 66251-2020
Attn.: Real Estate Attorney"

6. General Terms and Conditions.

(a) All capitalized terms used in this Amendment, unless otherwise defined herein, will have the same meaning as the terms contained in the Agreement.

(b) In case of any inconsistencies between the terms and conditions contained in the Agreement and the terms and conditions contained in this Amendment, the terms and conditions herein will control. Except as set forth below, all provisions of the Agreement are ratified and remain unchanged and in full force and effect.

(c) This Amendment may be executed in duplicate counterparts, each of which will be deemed an original.

(d) Each of the parties represent and warrant that they have the right, power, legal capacity and authority to enter into and perform their respective obligations under this Amendment.

SIGNATURES ON FOLLOWING PAGE



The parties have executed this Amendment as of the Effective Date.

Village:

Village of Downers Grove, an Illinois municipal corporation

By: _____

Name: _____

Title: _____

Date: _____
(Date must be completed)

Licensee:

Sprintcom, Inc., a Kansas Corporation

By: *Holly S. Castellanos*

Name: Holly S. Castellanos

Title: Manager, Real Estate

Date: _____
(Date must be completed) 9/1/09

