

VILLAGE OF DOWNERS GROVE
Report for the Village Council Meeting
3/8/2016

SUBJECT:	SUBMITTED BY:
Purchase of Replacement Vehicles – Public Works	Nan Newlon Director of Public Works

SYNOPSIS

A motion is requested to authorize the purchase of three 2016 Peterbilt Model 348 Cab and Chassis equipment from JX Peterbilt, Bolingbrook Illinois, in the total amount of \$567,639.15.

STRATEGIC PLAN ALIGNMENT

The goals for 2015-2017 include *Exceptional Municipal Services*.

FISCAL IMPACT

The FY16 budget includes \$550,000.00 in the Equipment Replacement Fund for the purchase of these three vehicles. The total cost of the vehicles presented for replacement on the March 8, 2016 agenda is \$80,000 under the budgeted amount.

RECOMMENDATION

Approval on the March 8, 2016 consent agenda.

BACKGROUND

The 2016 vehicle replacement schedule provides for the replacement of 14 vehicles. These three trucks will replace three of the Village's current 10 ton trucks that are used for plowing, salting, pretreating roads, snow hauling, paving, hauling stone, dirt and other materials.

Quantity	Type of Vehicle	Make and Model	Dealer	Price each with trade in
3	10 ton plow truck	2016 Peterbilt Model 348	JX Peterbilt	\$189,213.05

The Village's Fleet Team, consisting of representatives from the Village Manager's Office and Finance, Public Works, Police and Fire Departments evaluated the need to replace the vehicles. All Village vehicles and equipment are targeted for replacement according to useful lifecycle replacement criteria. These criteria include age, usage, condition, repair costs, fuel efficiency and environmental impact. The Fleet Team reviewed the vehicles scheduled to be replaced and determined that the criteria for replacement were met in this case.

The following table provides additional information regarding the vehicles scheduled to be replaced:

Veh.#	Year	Make	Model	Hours (Feb 2016)	2015 Repairs/ Maintenance Costs	Life-to-Date Repairs/ Maintenance Costs
205	2002	Freightliner	FL80	3,897	\$14,277.35	\$245,955.65
206	2002	Freightliner	FL80	3,849	\$6,195.41	\$158,403.21
207	2002	Freightliner	FL80	4,118	\$7,418.16	\$168,077.45

The purchase is recommended to be made through a cooperative purchasing contract in accordance with the provisions of the Village Purchasing Policy. The Model 348 Trucks would be purchased through a joint purchasing program from Lake County Illinois.

ATTACHMENTS

Lake County Joint Purchase Contract #15015
 JX Peterbilt Purchase Quote
 Lindco Modifications Sheet 160199
 Peterbilt Chassis Specification

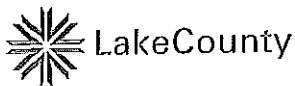

Lake County Purchasing Division
 18 North County Street - Ninth Floor
 Waukegan, Illinois 60085-4350
 (847) 377-2992

E-Mail: purchasing@lakecountvil.gov

Access Bid Results:
<http://www.lakecountypurchasingportal.com/>

SUBMISSION INFORMATION

INVITATION: # 15015
 BID OPENING DATE: February 12, 2015
 TIME: 2:00 P.M. Local Time
 LOCATION: Lake County
 Purchasing Division
 18 N. County St., 9th Floor
 Waukegan, IL 60085-4350

Submit 1 original and 1 electronic copy on a CD or flash drive

ISSUANCE DATE: January 13, 2015
 BUYER: Larry Wollheim

INVITATION TO BID VENDOR INFORMATION

COMPANY NAME: JX - Peterbilt
 ADDRESS: 42400 Hwy 41
 CITY, STATE, ZIP CODE: WADSWORTH, IL 60083

BID SHEET

REVISED PER ADDENDUM 1

Purchase of (4) Snow Plow Trucks for Lake County Division of Transportation

BID ITEM #	DESCRIPTION	QUANTITY	UNIT OF MEASURE	PRICE EACH	EXTENDED TOTAL
1.	Tandem Axle Snow Plow Trucks per specifications of Bid #15015. Manufacturer <u>Peterbilt</u> Model Name <u>348 Extended Cab</u>	4	Each	\$ <u>104,960</u>	\$ <u>419,840</u>
2.	Spec Item #21: Extended Warranty Cummins 2013 ISL-9 Protection Plan 1	4	Each	\$ <u>2,150</u>	\$ <u>8,600</u>
3.	Spec Item #21: Extended Warranty Cummins 2013 ISL-9 After Treatment Plan	4	Each	\$ <u>600</u>	\$ <u>2,400</u>
TOTAL					\$ <u>430,840</u>

A non-mandatory pre-bid conference will be held at 9:00 AM CST on Friday, January 23, 2015, at the Lake County Division of Transportation, Conference Room, 600 W. Winchester Road, Libertyville, IL 60048.

Firms interested in responding to this Invitation to Bid are urged to attend this pre-proposal meeting.

NOTE TO BIDDERS: Any and all exceptions to these specifications MUST be clearly and completely indicated on the bid sheet. Attach additional pages if necessary. Please be advised that any exceptions to these specifications may cause your bid to be disqualified.

If a bid includes any exceptions, Bidders must insert an "X" in the following box indicating a bid submission with exceptions.

All documents shall be properly signed and completed. Submit bids by sealed bid only. Fax and e-mail bids are not acceptable and will not be considered.

THE SECTION BELOW MUST BE COMPLETED IN FULL AND SIGNED

PROMPT PAYMENT DISCOUNT: 0 % 0 DAYS

The undersigned hereby certifies that they have read and understand the contents of this solicitation and agree to furnish at the prices shown any or all of the items above, subject to all instructions, conditions, specifications and attachments hereto. Failure to have read all the provisions of this solicitation shall not be cause to alter any resulting contract or to accept any request for additional compensation. By signing this bid document, the bidder hereby certifies that they are not barred from bidding on this contract as a result of a violation of either Section 33E-3 or 33E-4 of the Illinois Criminal Code of 1961, as amended.

Authorized Signature: [Signature] Company Name: JX - Peterbilt
 Typed/Printed Name: Todd Peterson Date: 2/10/15
 Title: Fleet Account Manager Telephone Number: 847-395-7222
 E-mail: tpeterson@jxe.com Fax Number: 847-395-7240

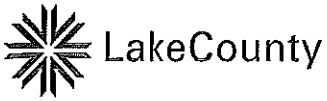

151813

Purchase Order Number must be shown on all packing lists & invoices

Date: 26-FEB-15

Ship To:
 Division Of Transportation Admin
 600 W Winchester Rd
 Libertyville, IL 60048

Revision: 0
Delivery Date: 24-FEB-2015
Terms: NET - 30
Req No: 5501066
Buyer: Y ALBARRAN
Buyer Phone: (847) 377-2141

Vendor:
 JX ENTERPRISES
 PETERBILT OF WISCONSIN
 42400 HWY 41
 WADSWORTH, IL 60083

Bill To:
 Division Of Transportation Admin
 600 W Winchester Rd
 Libertyville, IL 60048

Vendor Phone:

Vendor Fax:

Taxes: Tax Exempt No: E9995-7817-07

Note to Vendor:

This purchase order is subject only to the Lake County terms and conditions contained herein. Any additional or different terms contained in the Sellers document(s) are hereby deemed to be material alternations and notice of objection to them and rejection of them is hereby given.

Item	Description	Item Num	Quantity	Unit	Unit Price	Amount	
1	Purchase of (4) new, unused, 2016 Tandem Axle Snow Plow Trucks per specifications of Bid #15015. Pick up and delivery is included in the bid price. Manufacturer: Peterbilt Model Name: 348 Extended Cab SHIP TO: Address at top of page Extended Warranty Cummins 2013 ISL-9 Protection Plan 1 Total Cost for 4 Trucks - \$8600.00 Cummins 2013 ISL-9 After Treatment Plan Total Cost for 4 Trucks - \$2400.00 LAKE COUNTY CONTACT Josh Wallace @ 847-377-7411. Please tag delivery: ATTENTION - JOSH WALLACE PAPERWORK INSTRUCTIONS All Paperwork and Certificate of Origin should be made out as follows: County of Lake 600 Winchester Road Libertyville IL 60048		430,840.00	Dollars	1.0000	430,840.00	
FOB: Destination						TOTAL AMOUNT OF PURCHASE ORDER	430,840.00

Contact Buyer listed above for further information

26-FEB-15

Purchasing Agent

LAKE COUNTY PURCHASE ORDER TERMS AND CONDITIONS

1. **ACCEPTANCE OF PURCHASE ORDER.** A Purchase Order is given for immediate acceptance by the Seller. Unless promptly notified to the contrary, the County will assume the Seller accepts the order as written and will make delivery as specified on the document.
2. **ENTIRE AGREEMENT.** All specifications, drawings, and data submitted to the Seller with this order or the solicitation for this order are hereby incorporated herein and made a part hereof. This contract contains the entire agreement of the parties. No change in quantities, prices, specifications, terms or shipping instructions will be allowed except on written authority of the Lake County Purchasing Division. Any additional or different terms and conditions proposed by Seller are objected to and hereby rejected, unless specifically agreed to by the County.
3. **INDEMNIFICATION.** The Seller shall indemnify, keep and save harmless the County, its agents, officials, and employees from and against all injuries, losses, claims, suits, costs and expenses which may accrue against the County as a consequence of granting the Contract.
4. **MODIFICATION.** The County may, by written Order, make changes in the specifications if such changes are within the general scope of the Contract.
If such changes cause an increase or decrease in the Seller's costs or in the time required for performance of the Contract: (a) the seller shall promptly notify the County and assert its claim for adjustment within fifteen (15) calendar days and (b) an equitable adjustment shall be made by the County and the Contract modified accordingly. Nothing in this clause shall excuse the Seller from performing.
5. **DEFAULT.** Time is of the essence of this contract and if delivery of acceptable items or rendering of services is not completed by the time promised, the County reserves the right without liability, in addition to its other rights and remedies, to terminate this contract by notice effective when received by Seller, as to stated items not yet shipped or services not yet rendered, and to purchase substitute items or services elsewhere and charge the Seller with any and all losses incurred.
6. **TRANSPORTATION CHARGES.** Transportation expense for all shipments shall be prepaid to destination. Shipments sent C.O.D. or freight collect without the County's written consent will not be accepted and will, at Seller's risk and expense, be returned to Seller. No charges will be allowed by the County for transportation, packing, cartage or containers unless otherwise authorized in the Purchase Order.
7. **UNAVOIDABLE DELAY.** If the Seller is delayed in the delivery of goods purchased under the Purchase Order by a cause beyond its control, Seller must immediately, upon receiving knowledge of such delay, give written notice to the County and request an extension of time. The County shall examine the request and determine if the Seller is entitled to an extension.
8. **QUANTITY.** Quantities furnished in excess of those specified in the Purchase Order will not be accepted and will be held at Seller's risk and expense.
9. **INSPECTION.** Materials or equipment purchased are subject to inspection and approval at the County's destination. The County reserves the right to reject and refuse acceptance of items which are not in accordance with the instructions, specifications, drawings or data of Seller's warranty (express or implied). Rejected materials or equipment shall be removed by, or at the expense of, the Seller promptly after rejection.
10. **WARRANTY.** The Seller warrants that all goods and services furnished hereunder will conform in all respects to the terms of this order, including any drawings, specifications or standards incorporated herein, and that they will be free from latent and patent defects in materials, workmanship and title, and will be free from such defects in design. In addition, Seller warrants that said goods and services are suitable for, and will perform in accordance with, the purposes for which they are purchased, fabricated, manufactured and designed or for such other purposes as are expressly specified in this order. The County may return any nonconforming or defective items to the Seller or require correction or replacement of the item at the time the defect is discovered, all at the Seller's risk and expense. Acceptance shall not relieve the Seller of its responsibility.
11. **REGULATORY COMPLIANCE.** Seller represents and warrants that the goods or services furnished hereunder (including all labels, packages and container for said goods) comply with all applicable standards, rules and regulations in effect under the requirements of all Federal, State and local laws, rules and regulations as applicable, including the Occupational Safety and Health Act as amended, with respect to design, construction, manufacture or use for their intended purpose of said goods or services. Seller shall furnish "Material Safety Data Sheets" in compliance with the Illinois Toxic Substances Disclosure to Employees Act.
12. **ROYALTIES AND PATENTS.** Seller shall pay all royalties and license fees.
Seller shall defend all suits or claims for infringement of any patent, copyright or trademark rights and shall save the County harmless from loss on account thereof.
13. **EQUAL EMPLOYMENT OPPORTUNITY.** Equal Employment Opportunity Clause, Section 6.1 of the Illinois Department of Human Rights Rules and Regulations shall be a material term of this contract.
14. **PAYMENT.** Payments shall be made in accordance with the Local Government Prompt Payment Act.50 ILCS 505/1, or the Seller's invoice, whichever are more favorable to the County and payment date therefore shall be calculated from the receipt of invoice or receipt or final acceptance of the goods, whichever is later.
15. **IDENTIFICATION.** Invoices in duplicate with prices set out and giving the correct Purchase Order Number must be sent to the address shown on the face of this order, otherwise payment of Seller's account may be delayed. The Purchase Order Number shall appear on all invoices, boxes, packages, shipping documents and correspondence, and the list of contents shall be enclosed in each box or package.
16. **TERMINATION.** Buyer may, at any time, terminate this order in whole or in part by written or electronic notice or verbal notice confirmed in writing. Upon termination for convenience of Buyer, the Buyer will assume responsibility for specific contractual or scheduled financial commitments made prior to notice of termination. Any and all services, property, publications, or materials provided during or resulting from the Contract shall become the property of the Buyer. If however, termination is occasioned by Seller's breach of any condition hereof, including breach of warranty, or by Seller's delay, except due to circumstances beyond the Seller's control and without Seller's fault or negligence, Seller shall not be entitled to any claim or costs or to any profit referred to in said clause, and Buyer shall have against Seller all

remedies provided by law and equity.

17. TAXES. Lake County is not subject to Federal Excise Tax. Per Illinois Revised Statutes, Chapter 120, Paragraph 441: Lake County is exempt from State and local taxes. Exemption number is printed on the reverse side hereof. This order shall serve as the exemption certificate.

18. LAW GOVERNING. This contract shall be governed by and construed according to the laws of the State of Illinois. Jurisdiction and venue shall be found exclusively in the 19th Judicial Circuit Court, State of Illinois. 735 ILCS 5/2-103

19. INSURANCE. Seller shall procure and maintain in full force and effect, at its expense, products liability completed operations and other insurance which is customary for similar sellers in the industry. Vendor and vendors performing work on County owned or leased facilities or property shall during the entire term of the contract, maintain a minimum, the insurance coverage as identified in the Bid, RFP or County agreement related to.

20. LIABILITY. Any person, firm or corporation performing services pursuant to this Purchase Order shall be liable for all damages incurred while in performance of such services. Vendor assumes full responsibility for the work to be performed hereunder, and hereby releases, relinquishes and discharges the County, its officers, agents and employees, from all claims, demands and causes of action of every kind and character including the cost of defense thereof, for any injury to including death of any person whether that person be a third person, vendor or an employee of either parties hereto, and any loss of or damage to property, whether the same be that of either parties hereto or of third parties, caused by or alleged to be caused by, arising out of or in connection with the issuance of this order to Vendor, whether or not said claims, demands and causes of action in whole or in part are covered by insurance. Certificate of Insurance maybe required for but not limited to Commercial General Liability, Commercial Auto Liability, Workers Compensation, and Professional Liability Insurance.

21. PREVAILING WAGE If applicable the work performed shall be in accordance with the provisions of the Illinois Prevailing Wage Act 820 ILCS 130 et seq. Not less than the prevailing rate of wages as determined by the Illinois Department of Labor or determined by the Court on review shall be paid to all laborers, workers and mechanics performing work under this purchase order. Current prevailing rates may be viewed at <http://www.illinois.gov/idol/Laws-Rules/CONMED/Pages/rates.aspx>
Submission of certified payroll records is required prior to the issuance of payment.

22. ILLINOIS WORKERS ON PUBLIC WORKS ACT

In the employment and use of labor, the Contractor and any subcontractor of the Contractor shall conform to all Illinois Constitutional and statutory requirements including, but not limited to, the following: "Illinois Workers on Public Works Act, 30 ILCS 570/ et seq, including Public Act 096-0929 signed into law on June 16, 2010" which requires the use of Illinois labor if the current unemployment rate exceeds 5% for two (2) consecutive months. The current level of unemployment in the State of Illinois may be viewed at http://www.ides.illinois.gov/LMI/Pages/Current_Monthly_Unemployment_Rates.aspx



CERTIFICATE OF LIABILITY INSURANCE

DATE (MM/DD/YYYY)
2/26/2015

THIS CERTIFICATE IS ISSUED AS A MATTER OF INFORMATION ONLY AND CONFERS NO RIGHTS UPON THE CERTIFICATE HOLDER. THIS CERTIFICATE DOES NOT AFFIRMATIVELY OR NEGATIVELY AMEND, EXTEND OR ALTER THE COVERAGE AFFORDED BY THE POLICIES BELOW. THIS CERTIFICATE OF INSURANCE DOES NOT CONSTITUTE A CONTRACT BETWEEN THE ISSUING INSURER(S), AUTHORIZED REPRESENTATIVE OR PRODUCER, AND THE CERTIFICATE HOLDER.

IMPORTANT: If the certificate holder is an ADDITIONAL INSURED, the policy(ies) must be endorsed. If SUBROGATION IS WAIVED, subject to the terms and conditions of the policy, certain policies may require an endorsement. A statement on this certificate does not confer rights to the certificate holder in lieu of such endorsement(s).

PRODUCER R & R Insurance Services, Inc. 1581 E Racine Avenue PO Box 1610 Waukesha WI 53186	CONTACT NAME: Kerry Alaimo PHONE (A/C No. Ext): (262) 953-7188 FAX (A/C. No): (262) 953-1351 E-MAIL ADDRESS: Kerry.Alaimo@rrins.com														
INSURED JX Enterprises Inc 1320 Walnut Ridge Dr Ste 100 Hartland WI 53029	<table border="1" style="width: 100%; border-collapse: collapse;"> <tr> <th style="text-align: center;">INSURER(S) AFFORDING COVERAGE</th> <th style="text-align: center;">NAIC #</th> </tr> <tr> <td>INSURER A Motorists Commercial Mutual</td> <td style="text-align: center;">13331</td> </tr> <tr> <td>INSURER B United Wisconsin Ins Co</td> <td style="text-align: center;">29157</td> </tr> <tr> <td>INSURER C:</td> <td></td> </tr> <tr> <td>INSURER D:</td> <td></td> </tr> <tr> <td>INSURER E:</td> <td></td> </tr> <tr> <td>INSURER F:</td> <td></td> </tr> </table>	INSURER(S) AFFORDING COVERAGE	NAIC #	INSURER A Motorists Commercial Mutual	13331	INSURER B United Wisconsin Ins Co	29157	INSURER C:		INSURER D:		INSURER E:		INSURER F:	
INSURER(S) AFFORDING COVERAGE	NAIC #														
INSURER A Motorists Commercial Mutual	13331														
INSURER B United Wisconsin Ins Co	29157														
INSURER C:															
INSURER D:															
INSURER E:															
INSURER F:															

COVERAGES **CERTIFICATE NUMBER:** 14/15 Liability Cert **REVISION NUMBER:**

THIS IS TO CERTIFY THAT THE POLICIES OF INSURANCE LISTED BELOW HAVE BEEN ISSUED TO THE INSURED NAMED ABOVE FOR THE POLICY PERIOD INDICATED. NOTWITHSTANDING ANY REQUIREMENT, TERM OR CONDITION OF ANY CONTRACT OR OTHER DOCUMENT WITH RESPECT TO WHICH THIS CERTIFICATION MAY BE ISSUED OR MAY PERTAIN, THE INSURANCE AFFORDED BY THE POLICIES DESCRIBED HEREIN IS SUBJECT TO ALL THE TERMS, EXCLUSIONS AND CONDITIONS OF SUCH POLICIES. LIMITS SHOWN MAY HAVE BEEN REDUCED BY PAID CLAIMS.

INSR LTR	TYPE OF INSURANCE	ADDL INSR	SUBR WVD	POLICY NUMBER	POLICY EFF (MM/DD/YYYY)	POLICY EXP (MM/DD/YYYY)	LIMITS
A	GENERAL LIABILITY			2360648 (WI Only)	9/1/2014	9/1/2015	EACH OCCURRENCE \$
	<input type="checkbox"/> COMMERCIAL GENERAL LIABILITY						DAMAGE TO RENTED PREMISES (Ea occurrence) \$
	<input type="checkbox"/> CLAIMS-MADE <input type="checkbox"/> OCCUR						MED EXP (Any one person) \$
	<input checked="" type="checkbox"/> Contingent/Leasing Liab						PERSONAL & ADV INJURY \$
	GEN'L AGGREGATE LIMIT APPLIES PER:						GENERAL AGGREGATE \$
	<input type="checkbox"/> POLICY <input type="checkbox"/> PRO-JECT <input type="checkbox"/> LOC						PRODUCTS - COMPIOP AGG \$
							CONTINGENT Liability Limit \$ 1,000,000
A	AUTOMOBILE LIABILITY			2360649 (WI), 2360650 (IL), 2360651 (MI), 2360652 (IN)	9/1/2014	9/1/2015	COMBINED SINGLE LIMIT (Ea accident) \$ 500,000
	<input checked="" type="checkbox"/> ANY AUTO ALL OWNED AUTOS	<input type="checkbox"/> SCHEDULED AUTOS					BODILY INJURY (Per person) \$
	<input checked="" type="checkbox"/> HIRED AUTOS	<input checked="" type="checkbox"/> NON-OWNED AUTOS					BODILY INJURY (Per accident) \$
	<input checked="" type="checkbox"/> Garage Liability						PROPERTY DAMAGE (Per accident) \$
							Other Than Auto Only \$500,000 \$/ \$1,500,000
A	<input checked="" type="checkbox"/> UMBRELLA LIAB	<input checked="" type="checkbox"/> OCCUR		2360653	9/1/2014	9/1/2015	EACH OCCURRENCE \$ 10,000,000
	<input type="checkbox"/> EXCESS LIAB	<input type="checkbox"/> CLAIMS-MADE					AGGREGATE \$ 10,000,000
	<input type="checkbox"/> DED <input type="checkbox"/> RETENTION \$						
B	WORKERS COMPENSATION AND EMPLOYERS' LIABILITY			2000006655	4/1/2014	4/1/2015	<input checked="" type="checkbox"/> WC STATUTORY LIMITS <input type="checkbox"/> OTHER
	ANY PROPRIETOR/PARTNER/EXECUTIVE OFFICER/MEMBER EXCLUDED? (Mandatory in NH)	Y/N	N/A				E.L. EACH ACCIDENT \$ 1,000,000
	If yes, describe under DESCRIPTION OF OPERATIONS below	N					E.L. DISEASE - EA EMPLOYEE \$ 1,000,000
							E.L. DISEASE - POLICY LIMIT \$ 1,000,000
A	Dealer Physical Damage Limit Per State			WI \$21,750,000 MI 4,100,000 IL \$14,000,000 IN 5,200,000	9/1/2014	9/1/2015	Comprehensive Ded \$5,000 / \$ 25,000
							Collision Deductible \$ 5,000

DESCRIPTION OF OPERATIONS / LOCATIONS / VEHICLES (Attach ACORD 101, Additional Remarks Schedule, if more space is required)
 RE: Bid #15015, purchase of (4) Snow Plow Trucks for Lake County DOT. Lake County is listed as additional insured in regards to auto per form CA2048.

CERTIFICATE HOLDER (847) 984-5889 Lake Country Purchasing Division Attn: RuthAnne Hall, Lake County Purchasi 18 N. County 9th Floor Waukegan, IL 60085	CANCELLATION SHOULD ANY OF THE ABOVE DESCRIBED POLICIES BE CANCELLED BEFORE THE EXPIRATION DATE THEREOF, NOTICE WILL BE DELIVERED IN ACCORDANCE WITH THE POLICY PROVISIONS. AUTHORIZED REPRESENTATIVE Mike Obertin/KA510 <i>Michael Obertin</i>
---	---

Additional Named Insureds

Other Named Insureds

Alltrux Capital LLC	Additional Named Insured
DBA JX Peterbilt - Appleton	Doing Business As
DBA JX Peterbilt - Elmhurst	Doing Business As
DBA JX Peterbilt - Bloomington	Doing Business As
DBA JX Peterbilt - Bolingbrook	Doing Business As
DBA JX Peterbilt - Champaign	Doing Business As
DBA JX Peterbilt - Elmhurst	Doing Business As
DBA JX Peterbilt - Fort Wayne	Doing Business As
DBA JX Peterbilt - Green Bay	Doing Business As
DBA JX Peterbilt - Indianapolis	Doing Business As
DBA JX Peterbilt - Lansing	Doing Business As
DBA JX Peterbilt - Madison	Doing Business As
DBA JX Peterbilt - Milwaukee	Doing Business As
DBA JX Peterbilt - Rockford	Doing Business As
DBA JX Peterbilt - Wadsworth	Doing Business As
DBA JX Peterbilt - Waukesha	Doing Business As
DBA JX Peterbilt Grand Rapids	Doing Business As
DBA Peterbilt - Wausau	Doing Business As
DBA Peterbilt Central Illinois	Doing Business As
DBA Peterbilt Chicago - Bolingbrook	Doing Business As
DBA Peterbilt Northern Illinois	Doing Business As
JX Financial Inc	Additional Named Insured
JX Leasing Inc	Additional Named Insured
MCLEAN County Truck Co	Additional Named Insured
Peterbilt Illinois - Chicago Inc	Additional Named Insured

Additional Named Insureds

Other Named Insureds

Peterbilt of Illinois - Joliet Inc	Additional Named Insured
Peterbilt of Indiana Inc	Additional Named Insured
Peterbilt of Michigan Inc	Additional Named Insured
Peterbilt of Wisconsin Inc	Additional Named Insured
Wausau Truck Center Inc	Additional Named Insured

Bid # 15015

Purchase of (4) Snow Plow Trucks for the Lake County Division of Transportation, Libertyville, IL

BID SPECIFICATIONS for TANDEM AXLE TRUCK

Spec. No.	Product / Feature	Specification
23.	Value Added Services	<p>Please list any additional <u>value added services</u> your company may provide.</p> <p>① Pick-up and Delivery for Service located 70 minutes from LAKE COUNTY DOT FACILITY</p> <p>② 2x/day parts delivery, if necessary</p>

CONTRACTOR QUALIFICATIONS

Page 1 of 2

Bid # 15015 REVISED PER ADDENDUM 1 1/23/15**Purchase of (4) Snow Plow Trucks for the Lake County Division of Transportation, Libertyville, IL**

This section must be completed and returned with bid. Attach additional pages as required to complete required documentation. Contractor shall respond to each of the following **minimum** requirements indicated below. Contractor shall provide an explanation for each No ("Non-Compliant") response. Attach additional pages if necessary. Qualifications shall include, at a minimum:

#	Minimum Requirement/Qualifications	Yes (meets Requirement)	No (Does not meet this requirement)	Explanation
1.	Contractor must have experience in providing similar Trucks, repair parts, and service to other organizations of similar size for a minimum of five (5) years.	Yes		
2.	Contractor must have experience in providing high quality branded parts and factory-certified service.	Yes		
3.	Contractor must have experience in providing service within 24 hours and guaranteed repairs within five (5) days.	Yes		
4.	Contractor must have experience in providing applicable in-service training and product education for Lake County staff.	Yes		
5.	Contractor must have a sufficient inventory of replacement parts and availability within 24 hours.	Yes		
6.	Contractor must have the ability to perform in accordance with bid specifications.	Yes		
7.	Contractor must have all other necessary resources to provide timely service.	Yes		
8.	Contractor will deliver completed vehicles within ninety (90) days after receipt of purchase order. <u>REVISED PER ADDENDUM 1 1/23/15</u>	Yes		
9.	Contractor must have the necessary equipment and capability to furnish the items described in this bid. Provide a list of equipment owned/leased on Equipment Capability Form, herein.	Yes		
10.	All equipment included in this bid shall be warranted to be free from defects for a two (2) year period, 100% parts and labor, or for the manufacturer's standard warranty, whichever is longer. The warranty period shall end two (2) years after the vehicle "in-service" date, not the delivery date to Lake County.	Yes		

CONTRACTOR QUALIFICATIONS

Bid # 15015

Purchase of (4) Snow Plow Trucks for the Lake County Division of Transportation, Libertyville, IL

(This section must be completed and returned with bid. Attach additional pages as required to complete required documentation.)

Name and Address of Office from which this contract will be administered

Name: JX- Peterbilt

Administration Office Address: 42400 Hwy 41
WADSWORTH, IL 60083

Phone: 847-395-7222 Fax: 847-395-7240 Cell: 262-891-7224

Project Manager: Todd Peterson

Years in Business: 45 (Minimum 5 years) Number of Employees: 850
Annual Sales: \$ 600M + Dunn & Bradstreet #: 193 577418

List Employees Who Will be Dedicated to Lake County for the Administration of This Contract:
(Attach additional pages as necessary)

NAME	POSITION TITLE	NUMBER OF YEARS	AREA OF RESPONSIBILITY / EXPERIENCE	TASK
<u>Todd Peterson</u>	<u>Fleet Account Manager</u>	<u>20</u>	<u>Primary contact person for Lake County</u>	<u>Account Mgr</u>
<u>Cindy Campbell</u>	<u>GM</u>	<u>10</u>	<u>Secondary contact person for Lake County</u>	<u>General Mgr</u>
<u>Rich Cecil</u>	<u>Service Mgr.</u>	<u>6</u>	<u>Service</u>	<u>Service Mgr.</u>
<u>Barry Johnson</u>	<u>Parts Mgr.</u>	<u>1</u>	<u>Parts</u>	<u>Parts Mgr.</u>
_____	_____	_____	_____	_____

APPENDIX A

SUSTAINABILITY STATEMENT INSTRUCTIONS

The County of Lake is committed to green and sustainable practices and good environmental stewardship. Consequently, we are asking bidders to provide a Statement of Sustainability to ensure our bidders are also incorporating sustainability into their firms' practices.

INSTRUCTIONS

On the following Sustainability Statement form, provide a clear description of your firm's sustainable practices, policies, or procedures. These practices may include, but may not be limited to, the following categories and examples:

Waste Minimization within your office or facilities, such as a recycling programs, double-sided copying, electronic internal communications (i.e. memos), use of recycled-content materials and reusable cups, limiting printing, electronic document management, instituting green purchasing policies, using green cleaning supplies and practices, or reducing packaging in materials you procure or supply.

Energy Efficiency within your office, facilities, or firm, such as lighting retrofits, photo-sensor switches for lighting, effective use of daytime lighting, using Energy Star rated appliances or equipment, using an alternative fuel or having efficient fleet policies, an anti-idling policy, or indoor temperature management (i.e. turning the thermostat up in the summer and down in the winter).

Water Efficiency within the office, facilities, or firm, such as faucet or fixture retrofits, switching from individual bottled water to office water coolers or drinking fountains, and installing drought-tolerant landscaping.

Staff encouraged to adopt sustainable practices and supported by your firm through public transit benefits, bicycle accommodations, telecommuting options, support for green seminar attendance, becoming US Green Building Council LEED accredited, or creating an internal "green team."

Education of your staff about green practices, education of your business peers about your green accomplishments, education of your community by your sustainability, or notice of any environmental awards your firm has achieved.

CONTINUE TO NEXT PAGE

APPENDIX A

SUSTAINABILITY STATEMENT

Bid # 15015

Purchase of (4) Snow Plow Trucks for the Lake County Division of Transportation, Libertyville, IL

Bidder Name

JX- Peterbilt

Waste Minimization

Attach additional sheets if necessary.

Communication via email, copy double-sided when able,
 recycle: paper cardboard, bottles and cans, cloth hand towel
 dispenser in restrooms

Energy Efficiency

energy efficient light bulbs, light timers on outdoor lighting
 (i.e. Peterbilt sign), high efficiency HVAC system installed
 in summer of 2013, uses alternate fuel in shop (oil waste
 burner)

Water Efficiency

Water coolers

Staff

car pool when travelling to same functions, staff "thinks green"
 with everyday functions

Education

General Manager is water purification certified

REFERENCES**Bid # 15015****Purchase of (4) Snow Plow Trucks for the Lake County Division of Transportation, Libertyville, IL**

This section must be completed and returned with bid. Attach additional pages as required to complete required documentation. List below current/past customers and local governmental entities similar in size and scope of operation to Lake County where you have provided similar equipment or services as described in this bid.

1. Entity: City of Kenosha
 Address: 6415 35th ave.
 City, State, Zip Code: Kenosha WI 53142
 Telephone Number: 282-653-4070
 Description of Services and Equipment Provided:
348 plow trucks (3)
 Date of Service: 9/1/12 To 2/12/15

2. Entity: City of Burlington
 Address: 2200 S. Pine st.
 City, State, Zip Code: Burlington WI 53105
 Telephone Number: 262-539-3770
 Description of Services and Equipment Provided:
348 Peterbilt
 Date of Service: 10/13/09 To 2/12/15

3. Entity: Town of Somers
 Address: 7511 12th st
 City, State, Zip Code: Somers WI 53171
 Telephone Number: 262-895-2822
 Description of Services and Equipment Provided:
365 plow truck, 348 vac unit
 Date of Service: 1/18/12 To 2/12/15

Company: JX - PeterbiltAuthorized Signature: Date: 2/10/15Title: Fleet Account Manager



Addendum Acknowledgement Bid #15015

The undersigned acknowledges receipt of the following addendum(s):

ADDENDUM #	SIGNATURE
1	X <i>Todd Peterson</i>

I have examined and carefully prepared the submittal documentation in detail before submitting my response to Lake County.

Submittal Number: _____
 Company Name: JX- Peterson
 Authorized Representative: _____
 Authorized Representative: *Todd Peterson*
Signature
 Authorized Representative: Todd Peterson
Print
 Date: 2/10/15

It is the vendor's responsibility to check for addendums, posted on the website at <http://lakecountypurchasingportal.com> prior to the submittal due date. No notification will be sent when addendums are posted unless there is an addendum within three business days of the submittal due date.

If the submittal has already been received by Lake County, vendors are required to acknowledge receipt of addendum via email to purchasing@lakecountyil.gov prior to the due date.

Submittals that do not acknowledge addendums may be rejected.

All responses are to be submitted in a sealed envelope. Envelopes are to be clearly marked with required submittal information.



JX Peterbilt - Wadsworth P125
42400 Hwy 41

Lake County DOT
600 West Winchester Rd.

Wadsworth, Illinois United States 60083
Phone: (847) 395-7222
Fax: (847) 395-7240
Email:

Libertyville, Illinois United States 60048
Phone: (847) 377-7411
Fax:
Contact Email:
Prepared for: Josh Wallace

Horizontal Dimensions

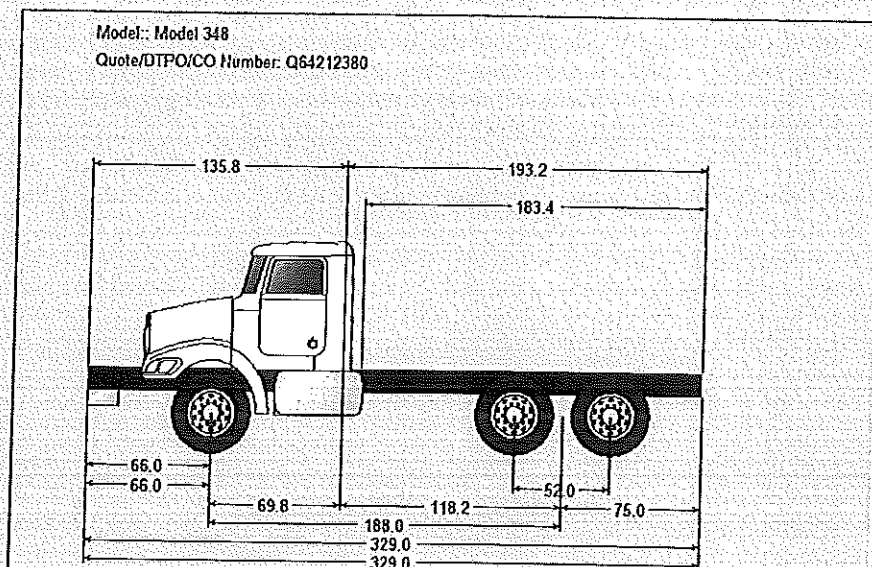

Unpublished options may require review/approval.
Dimensional and performance data for unpublished options may vary from that displayed in PROSPECTOR.

Printed:	2/9/2015 10:44:11 AM	Incomplete	Model Number:	Model 348
Effective Date:	Jan 1, 2015		Quote/DTPO/CO:	Q64212380
Prepared by:	ID: tpete		Version Number:	30.11

Printed: 2/9/2015
 Dealer No.: P125
 CAR NO: 01193924
 Create Date: 1/26/2015

REP: TODD PETERSON

Customer Information

Dealer Customer No.: Division Customer No.: 5ME7

Customer: Lake County DOT
 600 West Winchester
 Libertyville, IL 60048
 Contact Name: Wallace, Josh

General Information

Quantity: 4 - 6
 Requested Delivery Date: 4/16/2015 TO: 6/30/2015
 Superseded CAR #:
 Specific Chassis: -

Truck Specification:

Model: 348
 Engine MFG: CUMMINS
 Front Axle MFG: DANA SPC
 Rear Axle MFG: DANA SPC
 Transmission MFG: ALLISON
 Suspension MFG: PETERBILT.

Sleeper: NONSLPR
 Engine Model: PX-9
 Front Axle Model: 20000.00
 Rear Axle Model: 40000
 Transmission Model: OTHER
 Suspension Type: 40000
 Config/Size: 348 TDM
 HP: 345

Competitive Information

Competitor Name: KENWORTH

Model: T300 Price: \$1

Quotation Information

Dealer List: \$155,407
 Total Promo List: \$0
 Adj. Dir. List: \$155,407
 Dealer Net: \$132,096
 Dealer Option Cost: \$400
 Freight Cost: \$2,100
 PAC Cost: \$400
 PDI Cost: \$400
 Other Cost: \$390

Promotion Program: 0
 % \$0
 Sales Allowance: 30% \$39,629
 Exchange: 0
 Dealer Profit: .4% \$400
 Customer Quoted Price: \$99,463
 Trade: False
 Trade(Over) Allowance: \$0
 Prospector Version: 30.00

Promotion Codes:

Dealer Comments:
 last year car was 30 and # 01119684
 1114 price level

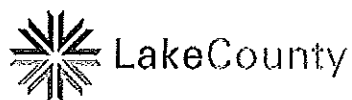

Purchasing Division

18 N. County St. - 9th FL
Waukegan, Illinois 60085
Phone 847 377 2029

February 24, 2015

JX – Peterbuilt
42400 Hwy 41
Wadsworth, IL 60083
Attn: Todd Peterson**CONTRACT DESCRIPTION:** Purchase of (4) Snow Plow Trucks for Lake County DOT
CONTRACT #15015

Dear Mr. Peterson:

You are hereby awarded Contract #15015 in the amount of \$430,840. Per the terms of the RFP #15015 please submit the required certificate of insurance. This is not an order. Vendors shall make deliveries only as directed by Purchase Order. Invoices must reference purchase order number to insure prompt payment.

Thank you for your interest in doing business with Lake County.

Sincerely,

RuthAnne Hall
Purchasing Agent

28. NON-ENFORCEMENT BY THE COUNTY

The Contractor shall not be excused from complying with any of the requirements of the Contract because of any failure on the part of the County, on any one or more occasions, to insist on the Contractor's performance or to seek the Contractor's compliance with any one or more of said terms or conditions.

29. JOINT PURCHASING

The purchase of goods and services pursuant to the terms of this Contract shall also be offered for purchases to be made by other governmental units, as authorized by the Governmental Joint Purchasing Act, 30 ILCS 525/0.01, et seq. (the "Act"). All purchases and payments made under the Act shall be made directly by and between each governmental unit and the successful bidder. The bidder agrees that Lake County shall not be responsible in any way for purchase orders or payments made by the other governmental units. The bidder further agrees that all terms and conditions of this Contract shall continue in full force and effect as to the other governmental units during extended terms. The credit or liability of each governmental unit shall remain separate and distinct. Disputes between bidders and governmental units shall be resolved between the immediate parties.

The bidder and the other governmental units may negotiate such other and further terms and conditions to this Contract ("Other Terms") as individual projects may require. To be effective, Other Terms shall be reduced to writing and signed by a duly authorized representative of both the successful bidder and the other governmental unit.

The bidder shall provide the other governmental units with all required documentation set forth in the solicitation including but not limited to: performance and payment bonds, Certificates of Insurance naming the respective governmental unit as an additional insured, and certified payrolls to the other governmental unit as required.

30. ECONOMIC OPPORTUNITY PROGRAM

Lake County launched a **Buy Local. Build Local. Work Local.** initiative in 2013 to increase the outreach and procurement opportunities for businesses located within Lake County, including women-owned businesses and minority-owned business enterprises (L/W/MBE). The overarching objective is to maximize participation from these businesses in the County's procurement process, in accordance with applicable law. The County will take all necessary and reasonable steps to assure that business enterprises defined as L/W/MBE shall have a fair opportunity to participate in County contracts. As part of its Economic Opportunity Program (EOP) commitment the County will make every effort to achieve the following objectives:

- (a) To ensure nondiscrimination in the award and administration of contracts;
- (b) To create a level playing field on which L/W/MBEs can compete fairly for contracts by providing any necessary training and assistance in bid preparation;
- (c) To ensure that the County's EOP is narrowly tailored in accordance with applicable law;
- (d) To establish a means for firms identifying themselves as L/W/MBEs to register for procurement opportunities and work cooperatively with contracted firms to report on measures that demonstrates the County's commitment to its EOP; and,
- (e) To help remove barriers to the participation of L/W/MBEs through notification of contract opportunities.

Successful bidders are encouraged to work with Workforce Development to post any and all opportunities for employment on County contracts. Lake County's Workforce Development mission is to foster and ensure the economic prosperity of the Lake County community by maximizing the potential of businesses and workers. As such, Workforce Development provides a key resource for job seekers and employers.

State law mandates an open and competitive bidding process and requires that publicly procured contracts be awarded to the lowest responsible and responsive bidder with no demonstrated preference based on the bidder's location, race and gender.

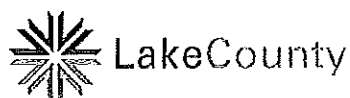

Purchasing Division

18 N. County St. - 9th FL
Waukegan, Illinois 60085
Phone 847 377 2929

INSURANCE REQUIREMENTS PER Bid #15015

The contractor must obtain, for the Contract term and any extension of it, insurance issued by a company or companies qualified to do business in the State of Illinois with an A.M. Best Rating of at least A-. Insurance in the following types and amounts is necessary:

Workers Compensation (Coverage A) and Employers Liability (Coverage B)

Workers Compensation Insurance covering all liability of the Contractor arising under the Worker's Compensation Act and Worker's Occupational Disease Act at limits in accordance with the laws of the State of Illinois. Employers' Liability Insurance shall be maintained to respond to claims for damages because of bodily injury, occupational sickness, or disease or death of the Contractor's employees, with limits listed below:

Employers Liability

- a) Each Accident \$1,000,000
- b) Disease-Policy Limit \$1,000,000
- c) Disease-Each Employee \$1,000,000

Such Insurance shall contain a waiver of subrogation in favor of Lake County.

Commercial General Liability Insurance

In a broad form on an occurrence basis shall be maintained, to include, but not be limited to, coverage for property damage, bodily injury (including death), personal injury and advertising injury in the following coverage forms where exposure exists:

- Premises and Operations
- Independent Contractors
- Products/Completed Operations
- Liability assumed under an Insured Contract/ Contractual Liability
- Personal Injury and Advertising Injury

With limits of liability not less than:

- \$ 1,000,000 Each Occurrence
- \$ 1,000,000 Products-Completed Operations
- \$ 1,000,000 Personal and Advertising injury limit
- \$ 2,000,000 General aggregate; the CGL policy shall be endorsed to provide that the General Aggregate limit applies separately to each of the contractor's projects away from premises owned or rented to contractor.

Automobile Liability Insurance

Automobile liability Insurance shall be maintained to respond to claims for damages because of bodily injury, death of a person, or property damage arising out of ownership, maintenance, or use of a motor vehicle. This policy shall be written to cover any auto whether owned, leased, hired, or borrowed. This policy must provide property damage and bodily injury coverage for the County's vehicle while the vehicle is under the possession and/or control of Contractor during warranty service and/or repairs or maintenance and where the County's vehicle is under the possession and/or control of Contractor while the County's vehicle is being transported for delivery or service. The Contractor's auto liability Insurance, as required above, shall be written with limits of insurance not less than the following:

- \$ 1,000,000 Combined single Limit (Each Accident)

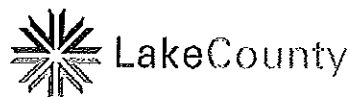

Purchasing Division

18 N. County St. - 9th Fl.
Waukegan, Illinois 60085
Phone 847 377 2929

Excess/ Umbrella Liability

The Contractor's Excess/ Umbrella liability insurance shall be written with the umbrella follow form and outline the underlying coverage, limits of insurance will be:

\$ 10,000,000 per occurrence limit

Contractor agrees that with respect to the above required insurance:

- a) The CGL policy shall be endorsed for the general aggregate to apply on a "per Project" basis;
- b) The Contractor's Insurance shall be primary in the event of a claim.
- c) Contractor agrees that with respect to the above required insurance, Lake County shall be named as additional insured, including its agents, officers, and employees and be provided with thirty (30) days' notice, in writing by endorsement, of cancellation or material change;
- d) Lake County shall be provided with Certificates of Insurance and endorsements evidencing the above required insurance, prior to commencement of this Contract, and thereafter annually for contracts/ projects that will last more than one year. The Contractor shall further provide Lake County with certificates evidencing renewals or replacements of said policies of insurance at least thirty (30) days prior to the expiration of cancellation of any such policies. Said Notices and Certificates of Insurance shall be provided to:

Lake County
Purchasing Division
18 N. County 9th Floor
Waukegan, Illinois 60085
Attn: RuthAnne Hall, Lake County Purchasing Agent

Failure to Comply: In the event the Contractor fails to obtain or maintain any insurance coverage required under this agreement, the Lake County may purchase such Insurance coverage and charge the Expense thereof to the Contractor.

LAKE COUNTY - INVITATION FOR BIDS: TERMS AND CONDITIONS

1. **AUTHORITY.** This Invitation for Bids is issued pursuant to applicable provisions of the Lake County Purchasing Ordinance.
2. **BID OPENING.** Sealed bids will be received at the Lake County Purchasing Department until the date and time specified, at which time they shall be opened in public. Late bids shall be rejected and returned unopened to the sender. Lake County does not prescribe the method by which bids are to be transmitted; therefore, it cannot be held responsible for any delay, regardless of the reason, in transmission of the bids.
3. **BID PREPARATION.** Bids must be submitted on this form and all information and certifications called for must be furnished. Bids submitted in any other manner, or which fail to furnish all information or certificates required, may be summarily rejected. Bids may be modified or withdrawn prior to the time specified for the opening of bids. Bids shall be filled out legibly in ink or typewritten with all erasures, strike overs and corrections initialed in ink by the person signing the bid. The bid shall include the legal name of the bidder, the complete mailing address, and be signed in ink by a person or persons legally authorized to bind the bidder to a contract. Name of person signing should be typed or printed below the signature.
4. **BID ENVELOPES.** Envelopes containing bids must be sealed and addressed to the County of Lake Purchasing Division. The name and address of the bidder and the Invitation Number must be shown in the upper left corner of the envelope.
5. **ERRORS IN BIDS.** Bidders are cautioned to verify their bids before submission. Negligence on the part of the bidder in preparing the bid confers no right for withdrawal or modification of the bid after it has been opened. In case of error in the extension of prices in the bid, the unit prices will govern.
6. **RESERVED RIGHTS.** The County of Lake reserves the right at any time and for any reason to cancel this Invitation for Bids, accept or reject any or all bids or any portion thereof, or to accept an alternate bid. The County reserves the right to waive any immaterial defect in any bid. Unless otherwise specified by the bidder or the County, the County has ninety (90) days to accept. The County may seek clarification from any bidder at any time and failure to respond promptly is cause for rejection.
7. **INCURRED COSTS.** The County will not be liable for any costs incurred by bidders in replying to this Invitation for Bids.
8. **AWARD.** It is the intent of the County to award a contract to the lowest responsible bidder meeting specifications. The County reserves the right to determine the lowest responsible bidder on the basis of an individual item, groups of items, or in any way determined to be in the best interests of the County. Award will be based on the following factors (where applicable): (a) adherence to all conditions and requirements of the bid specifications; (b) price; (c) qualifications of the bidder, including past performance, financial responsibility, general reputation, experience, service capabilities, and facilities; (d) delivery or completion date; (e) product appearance, workmanship, finish, taste, feel, overall quality, and results of product testing; (f) maintenance costs and warranty provisions; and (g) repurchase or residual value.
9. **PRICING.** The price quoted for each item is the full purchase price, including delivery to destination, and includes all transportation and handling charges, premiums on bonds, material or service costs, patent royalties and all other overhead charges of every kind and nature. Unless otherwise specified, prices shall remain firm for the contract period.
10. **DISCOUNTS.** Prices quoted must be net after deducting all trade and quantity discounts. Where cash discounts for prompt payment are offered, the discount period shall begin with the date of receipt of a correct invoice or receipt or final acceptance of goods, whichever is later.
11. **TAXES.** Lake County is not subject to Federal Excise Tax. Per Illinois Compiled Statutes, 35 ILCS 120/2-5, Lake County is exempt from state and local taxes.
12. **SPECIFICATIONS.** Reference to brand names and numbers is descriptive, but not restrictive, unless otherwise specified. Bids on equivalent items will be considered, provided the bidder clearly states exactly what is proposed to be furnished, including complete specifications. Unless the bidder specified otherwise, it is understood the bidder is offering a referenced brand item as specified or is bidding as specified when no brand is referenced, and does not propose to furnish an "equal." The County reserves the right to determine whether a substitute offer is equivalent to and meets the standard of quality indicated by the brand name and number.
13. **SAMPLES.** Samples of items, when called for, must be furnished free of expense and, if not destroyed in the evaluation process, will, upon request, be returned at the bidder's expense. Request for the return of samples must accompany the sample and include UPS Pickup Slip, postage or other acceptable mode of return. Individual samples must be labeled with bidder's name, invitation number, item reference, manufacturer's brand name and number.
14. **INTERPRETATION OR CORRECTION OF BIDDING DOCUMENTS.** Bidders shall promptly notify the County of any ambiguity, inconsistency or error which they may discover upon examination of the bidding documents. Interpretations, corrections and changes will be made by addendum. Each bidder shall ascertain prior to submitting a bid that all addenda have been received and acknowledged in the bid.
15. **INDEMNIFICATION.** The Seller shall indemnify and hold harmless the County, its agents, officials, and employees from and against all injuries, losses, claims, suits, costs and expenses which may accrue against the County as a consequence of granting the Contract.
16. **DEFAULT.** Time is of the essence of this contract and if delivery of acceptable items or rendering of services is not completed by the time promised, the County reserves the right, without liability, in addition to its other rights and remedies, to terminate the contract by notice effective when received by Seller, as to stated items not yet shipped or services not yet rendered and to purchase substitute items or services elsewhere and charge the Seller with any or all losses incurred. The County shall be entitled to recover its attorney's fees and expenses in any successful action by the County to enforce this contract.
17. **INSPECTION.** Materials or equipment purchased are subject to inspection and approval at the County's destination. The County reserves the right to reject and refuse acceptance of items which are not in accordance with the instructions, specifications, drawings or data of Seller's warranty (express or implied). Rejected materials or equipment shall be removed by, or at the expense of, the Seller promptly after rejection.
18. **WARRANTY.** Seller warrants that all goods and services furnished hereunder will conform in all respects to the terms of this solicitation, including any drawings, specifications or standards incorporated herein, and that they will be free from latent and patent defects in materials, workmanship and title, and will be free from such defects in design. In addition, Seller warrants that said goods and services are suitable for, and will perform in accordance with, the purposes for which they are purchased, fabricated, manufactured and designed or for such other purposes as are expressly specified in this solicitation. The County may return any nonconforming or defective items to the Seller or require correction or replacement of the item at the time the defect is discovered, all at the Seller's risk and expense. Acceptance shall not relieve the Seller of its responsibility.
19. **REGULATORY COMPLIANCE.** Seller represents and warrants that the goods or services furnished hereunder (including all labels, packages and container for said goods) comply with all applicable standards, rules and regulations in effect under the requirements of all Federal, State and local laws, rules and regulations as applicable, including the Occupational Safety and Health Act as amended, with respect to design, construction, manufacture or use for their intended purpose of said goods or services. Seller shall furnish "Material Safety Data Sheets" in compliance with the Illinois Toxic Substances Disclosure to Employees Act.
20. **EQUAL EMPLOYMENT OPPORTUNITY.** Contractor shall comply with the Illinois Human Rights Act, 775 ILCS 5/1-101 et seq., as amended and any rules and regulations promulgated in accordance therewith, including, but not limited to the Equal Employment Opportunity Clause, Illinois Administrative Code, Title 44, Part 750 (Appendix A), which is incorporated herein by reference. Furthermore, the Contractor shall comply with the Public Works Employment Discrimination Act, 775 ILCS 10/0.01 et seq., as amended.
21. **ROYALTIES AND PATENTS.** Seller shall pay all royalties and license fees. Seller shall defend all suits or claims for infringement of any patent, copyright or trademark rights and shall hold the County harmless from loss on account thereof.
22. **LAW GOVERNING.** This contract shall be governed by and construed according to the laws of the State of Illinois. Jurisdiction and venue shall be found exclusively in the 19th Judicial Circuit Court, State of Illinois.

Bid # 15015 REVISED PER ADDENDUM 1 1/23/15

Purchase of (4) Snow Plow Trucks for the Lake County Division of Transportation, Libertyville, IL

SPECIFICATIONS

NOTE: Bidder shall write the word "meets" to indicate that the proposed Vehicles meet the specifications or write the specified variations to the specifications in the spaces provided. Unless otherwise indicated, bidders are responsible to provide a

Tandem Axle Truck that meets or exceeds the bid specifications. Exceptions to the specifications must be clearly indicated below and may cause your bid to be disqualified. Complete the below and return with your bid. (Use additional paper as required, reference all attachments.)

BID SPECIFICATIONS for TANDEM AXLE TRUCK: VEHICLE PROFILE

Spec. No.	Product / Feature	Specification (Overview Drawing)	Bidder Proposes to Furnish (Write "MEETS" as applicable) or respond as requested
1.		<p>The drawing shows a side profile of a truck with a tandem axle configuration. Dimensions are provided for various parts of the truck's chassis and body. The front wheel is positioned 66.0 units from the front edge of the chassis. The front suspension components are 66.0 units apart. The front axle is 69.8 units from the front of the chassis. The front overhang is 135.8 units. The wheelbase (distance between the front and first rear axle) is 193.2 units. The distance between the two rear axles is 118.2 units. The first rear axle is 52.0 units from the centerline, and the second rear axle is 76.0 units from the centerline. The total length of the chassis is 329.0 units. The height of the chassis is 188.0 units.</p>	<p><i>Meets</i></p>

Bid # 15015

Purchase of (4) Snow Plow Trucks for the Lake County Division of Transportation, Libertyville, IL

BID SPECIFICATIONS for TANDEM AXLE TRUCK

Spec. No.	Product / Feature	Specification	Bidder Proposes to Furnish (Write "MEETS" as applicable) or respond as requested
2.	Chart of Dimensions	Dimensions	Inches
		Bumper to Back of Cab (BBC)	135.8
		Bumper to Centerline of Front Axle (CA)	66.0
		Back of Cab to Centerline of Rear Axle(S)	118.2
		Back of Cab to End of Frame	193.2
		Cab Height(CH)	72.0
		Wheelbase(WB)	186.0
		Frame Overhang(OH)	75.0
		Overall Length(OAL)	329.0
		Rear Axle Spacing	52.0
Unladen Frame Height at Centerline of Rear Axle	44.2		
3.	Dimensions	10" Extended CAB or Comparable	Meets ↓
		Wheelbase 186 INCH WHEELBASE	
		Rear Frame Overhang Center of Trunnion to Rear of Frame 75 Inch	
		Cab Size 118 INCH ALUMINUM Extended Day Cab BBC Metton Hood Includes View Window RH Door and Convex Mirror Over RH Door	
4.	Vehicle Configuration	10" Extended CAB or Comparable	↓
		2016 MODEL YEAR SPECIFIED	
		SET BACK AXLE - TRUCK	
		TRAILER TOWING PROVISION AT END OF FRAME FOR TRUCK	
		Speedometer Signal Wire For Salter	
5.	Vehicle Specifications Summary GVWR	LH PRIMARY STEERING LOCATION	↓
		Extended Day Cab or Comparable	
		Expected Front Axle(s) Load (lbs.) 20,000	
		Expected Rear Axle(s) Load (lbs.) 40,000	
		Expected GCW (lbs.) 60,000	
		Front Axle: Dana Spicer D2000F 20,000 lbs. 3.5 in Drop	
		Front Suspension: Taper Leaf Springs, Shocks 20,000 lbs.	
		Front Hubs: PHP 10 Aluminum LMS Hubs Air Disc	
		Front Disc Wheels: Alcoa 893630 Plt 22.5X9.00 Aluminum Wheel 10,000 lbs. load rating per wheel	
		Front Tires: BR (or equivalent) 20 ply 315/80R22.5 M860	
		Front Brakes: Bendix Air Disc Brakes	
		Steering Gear: Power Steering TRW THP-60Dual	
		Rear Axle: Dana Spicer DSP41 40,000 lbs.	
		Rear Suspension: Rear Air Suspension 40,000 lbs. W Horizontal & Vertical Tracking Rods Or Equivalent	
		Rear Hubs: Php 10 Iron LMS Hub 11-1/4" Bolt Circle	
Rear Disc Wheels: Accuride 50291 Plt 22.5X8.25 Steel Wheel Heavy Duty			
Rear Tires: BR (or equivalent) 14ply 11R22.5 M711			
Rear Brakes: Bendix Air Disc			

Bid # 15015

Purchase of (4) Snow Plow Trucks for the Lake County Division of Transportation, Libertyville, IL

BID SPECIFICATIONS for TANDEM AXLE TRUCK

Spec. No.	Product / Feature	Specification	Bidder Proposes to Furnish (Write "MEETS" as applicable) or respond as requested	
6.	Engine Equipment	Shall be a Cummins ISL-9 345@19000 GOV@2100 1150@1400	Meets	
		Belly Pan		
		Carb Engine Idling Compliance NOx Idling Standard. Will Include Factory Installed Serial Sticker On The Driver's Door To Identify Them As Meeting The NOx Idling Standard		
		160 Amp Alternator, 12V System With Circuit Protection		
		Immersion Type Pre-Heater 110-120V		
		12V Starter		
		3 Optima DT31T Batteries 2700 CCA Thread Stud Type Stranded copper battery cables are double aught (00) or larger Stud Type Terminal		
		Battery Disconnect Switches (2) Mounted In Cab Side Of Driver Seat		
		Battery Jumper Terminal Mounted Under Hood LH Frame Rail		
		On/Off Fan Clutch		
		18.7 CFM Air Compressor Furnished On Engine, Teflon Lined Stainless Steel Braided Compressor Discharge Line		
		VGT Exhaust Brake		
		Spin-on Fuel Filter Frame Mounted, Heated		
		Engine Protection Shut down, Oil Pressure, Oil Temperature, Coolant Temperature and Intake Manifold Temperature		
		High Efficiency Cooling System		
		Low Coolant Sensor		
		Silicone Radiator & Heater Hoses		
		No...Idle Shut Down Enable		
		65... Min Speed In Top Gear		
		65...Min Cruise Speed		
Disable Shut Down Timer				
Radial Seal, Dry Type Air Cleaner Molded Rubber Air Intake Connections With Lined Stainless Steel Clamps				
Exhaust Single RH Side Of Cab DPF/SCR RH under Cab. Includes Cab Entry RH Under Cab and Full Round Stainless Steel Exhaust Guard				
Curved Tip Standpipe(s)	Meets			
24in HT, 5in DIA Chrome, Clear Coat Standpipe(s)				
7.		Transmission Equipment	Allison 3000 RDS-P Transmission, Gen 5	Meets
			(1)Dash Mounted Single Acting Air PTO Control	
			Auto Neutral Activates With Parking Brake	
			Allison 6-Speed Configuration Close Ratio Gears	
			Dash Mounted Push Button Shifter	
			Allison Load Base Shift Schedule (LBSS)	
			1710 HD Driveline, Single Midship Bearing	
			Dipstick to be mounted on passenger side to allow for PTO clearance on driver's side	
8.		Front Axle and Equipment	Dana Spicer D2000F 20,000 lbs., 3.5 inc Drop	Meets
			Zerk fittings on tie rod ends, king-pins & draglink ball joints	
			Taper Leaf Springs, Shocks 20,000 LB	
			Power Steering TRW THP60 Dual Gildekot Splines On Steering Shaft	
			Power Steering Reservoir Frame Mounted W/Cooler	
			PHP10 Aluminum LMS Hubs-Air Disc	
			Bendix Air Disc Front Brakes, Complies with reduced stopping distance regulations	
SYNTHETIC 75W-90 AXLE LUBE				

Bid # 15015

Purchase of (4) Snow Plow Trucks for the Lake County Division of Transportation, Libertyville, IL

BID SPECIFICATIONS for TANDEM AXLE TRUCK

Spec. No.	Product / Feature	Specification	Bidder Proposes to Furnish (Write "MEETS" as applicable) or respond as requested
9.	Rear Axle Suspension and Equipment	Dana Spicer DSP41 40,000 lbs., Interaxle Diff Lock Air Rocker or Equivalent	Meets
		Magnetic Rear Axle Oil Drain Plug	
		Parking brakes on all drive axles	
		PHP 10 Iron LMS Hub 11-1/4 Bolt Circle	Alum
		Dust Shields for Cam Brakes, Drive Axle(S)	
		Diff Lock Both Axle(S)	
		Lube Pump, Drive Axle(S)	
		SBM Valve	
		Anti-Lock Braking system 4S4M ABS-6 Includes Air Braking System	
		Bendix Air Disc	
		Tandem Drive Axle	
		Ratio 5.57 Rear Axle	
		Rear Air Ride Suspension 40,000 lbs., Horizontal & Vertical Tracking Rods or Equivalent	
		Dash MTD Dump Switch With Indicator Light	
SYNTHETIC 75W-90 AXLE LUBE			
Gusset Cam Brackets, Drive Axle(s)			
10.	Air & Trailer Connections	Bendix AD-IS Air Dryer with Heater Incorporates the Functions Of The Air Dryer, Purge reservoir, Wet Air Tank, Pressure relief Valve Single Check Valve, Single Check Valves, and Pressure Protection Valve. Also Includes Spin on Desiccant Cartridge.	Meets
		Nylon Chassis Hose	
		Aluminum Painted Air Tanks	
		High Mount Air Tanks BOC/BOB	
		Install Frame mounted Air Tanks, As Far Forward As Possible	
		Waterproof Junction Box At End Of Frame Without Wiring A&E Conn End Of Frame w/7-Way Socket (W/Conn End Of Frame Strapped To The Rail)	✓
11.	Wheel Base and Frame	186 INCH WHEELBASE	188
		PARTIAL INNER FRAME REINFORCEMENT AT FRONT SUSPENSION	
		75 INCH REAR FRAME OVERHANG	
		27.8 INCH INTEGRAL FRONT FRAME EXTENSION	
		SQUARE END OF FRAME	
		FRONT CLOSING CROSS MEMBER	
		STANDARD WEIGHT ENGINE CROSS MEMBER	
		STANDARD MID SHIP #1 CROSS MEMBER(S) STANDARD REARMOST CROSS MEMBER HEAVY DUTY SUSPENSION CROSS MEMBER	
12.	Frame & Equipment	11-5/8 In Steel Rails to 444 In 11.625X3.874X.375 Dimension, 2,568,00RBM FEPTO Provision 27.8 In Bumper Extension Includes Crank Shaft Adapter Plate & Stationary Grille	
		End Of Frame Square Without X member	
		Omit Rear Mud flaps And Hangers	
		GRADE 8 THREADED HEX HEADED FRAME FASTENERS or Huckbolt fasteners	
		Three (3) Piece Cross Members	
13.	Fuel Tank	23 Inch Aluminum 70 Gallon Fuel Tank LH Under Chassis, Paddle Handle Filler Cap with Threadless Filler Neck. Top Draw Plumbing	Meets
		Wire Braid Fuel Lines	
		Def Tank Mounted LH BOC	
		Fuel Heater, Integral pick-Up tube	
		FUEL TANK CAP(S) Small DEF Tank	

Bid # 15015

Purchase of (4) Snow Plow Trucks for the Lake County Division of Transportation, Libertyville, IL

BID SPECIFICATIONS for TANDEM AXLE TRUCK

Spec. No.	Product / Feature	Specification	Bidder Proposes to Furnish (Write "MEETS" as applicable) or respond as requested
14.	Hubs	PHP 10 Aluminum (or equivalent) LMS Hubs- Air Disc PHP 10 Aluminum (or equivalent) LMS Hub 11-1/4" Bolt Circle	Meets
15.	Wheels	Alcoa 893630 Plt 22.5X9.00 Aluminum Wheel Pilot Mount 10,000 lbs. Load Rating Per Wheel ACCURIDE 50291 Plt 22.5X8.25 Aluminum Wheel Heavy Duty	↓ Meets
16.	Cab & Equipment	118" extended Cab, or Comparable, BBC Metton Hood W/Bright Crown Includes View Window RH Door And Convex Mirror Over RH Door	Meets
		Cab Air Suspension	
		Service Cab Package #1 Or Equivalent Aluminum Side Skins, Rear, Steel Windshield Mask, Steel Firewall and Steel Front Floor Sheet, And Additional Reinforcement Structure On Back Wall Of The Day Cab	
		Thermal Insulation Includes Thick Close-Cell Foam In Floor, Mylar Faced Foam In Walls And Roof	
		Black Mats With Single Insulation	
		Dash Mounted Ash Tray(S) Without Lighter	
		Rubber Fender Lips 2.25 Inch Wide	
		UltraRide Driver Seat, or Equivalent	
		UltraRide Passenger Seat, or Equivalent	
		Standard Black Seat	
		Mounted On In-Cab Battery Box	
		Air Ride Driver	
		High Back Driver Cloth	
		Low Back Passenger Cloth	
		Adjustable Steering Column- Tilt/Telescope	
		Interior Grey/Black Glare-resistant Gray Dash, (2) Power Ports, Monochromatic Molded door pads, 18 Inch 4 Spoke Soft Touch Steering Wheel, Rubber Floor Cover, Header Mounted Dome Light , Foot Well Lighting , Integrated "Dead Pedal", (4) Inside Entry Grab Handles, (2) inside Sun visors, (2) Coat Hooks, (2) Cup Holders And Map Bin In Dash	
		Day Cab Rear Window	
		One Piece Curved Windshield	
		Combo Fresh Air Heater/ Air Conditioner Radiator Mounted Condenser, Dedicated Side Window Defrosters, Bi-Level Heater/Defroster Controls 54,500 BTU/HR And Silicone Heater Hoses	
		Outside Sun visor, Stainless Steel	
		Stainless Steel Mirror(S) Each Side Heated and Motorized With Switch On Door	
		(2) Convex 8 INCH SS Mirror Center Mounted Under Mirror Bracket Heated	
		Polished Lower Mirror Bracket Covers	
		Power Door Locks and Power Windows Mounted on Door	
		(2) Air horns to be roof mounted, Pull Cord and Plumbing to be roof mounted as	
		Concert Class Audio System With CD or Equivalent	
CB Terminals/Wiring Mounted Under Header			
Electric Windshield Wipers With Intermittent Feature			
Triangle Reflector Kit Shipped Loose			
5 LB 3A:40bc Fire Extinguisher Cab Mounted			
Backup Alarm: (107 dB)			
Air Restrictor Indicator- Filter minder Mounted On Air Cleaner or Intake Piping			
Buzzer On Air Suspension Dump Valve, Dash Mounted Dump Valve			
Bright Bezel Gauges	Meets		

Bid # 15015

Purchase of (4) Snow Plow Trucks for the Lake County Division of Transportation, Libertyville, IL

BID SPECIFICATIONS for TANDEM AXLE TRUCK

Spec. No.	Product / Feature	Specification	Bidder Proposes to Furnish (Write "MEETS" as applicable) or respond as requested
16.	Cab & Equipment (CONTINUED)	Main Instrumentation Panel W/Graphic Displays. Includes Speedometer With Trip odometer, Tachometer With Hour meter and Outside Air Temperature Display, Voltmeter, Engine Oil Pressure, Engine Coolant Temperature, Fuel Level, Primary and Secondary Air Pressure Gauges, Includes Standard Warning Light package: High Water Temperature, Low Oil Pressure, and Low Air Pressure Warning Lights W/Audible Alarms, High Beams, Turn Signal, Low Fuel, Parking Brake and Ice Warning Indicators, Seat Belt Reminder, (5) Rocker Switches With LED Indicators,(1) 2 Position Switch: Up Momentary/Center Off/ Down Momentary, Multi-Function Turn Stalk With Flash-To-Pass Feature(Night Mode Flashes Headlights and Marker Lights: Day Mode Flashes Headlights Only), Intermittent Windshield Wiper and Headlamp Beam Headlights Composite Fender Mounted W/Integral Integral Park, Turn and Side Maker (5) Marker Lights, Aero LED (2) Additional Dome/Reading Lights, Ceiling Mounted	Meets ↓
17.	Battery Box	Omit Standard Battery Box DPF Cab Entry Aluminum Non-Slip Step RH Under Cab Steel Bumper Swept Back Painted Fepto Only With Two Tow Pin Holes and Step Plates On Top Of Bumper	↓
18.	Design	PAINT: TWO (2) SOLID COLORS. See Spec Section 19.	↓
19.	Colors	Cab Color: L0135EB Yellow Hood Top Color: L0135EB Yellow Fender Color: L0135EB Yellow Frame and Chassis Color: N0001EA Black	Meets ↓
20.	Certification Compliance	U.S. FMVSS CERTIFICATION	
21.	Extended Warranty <u>REVISED PER ADDENDUM 1 1/23/15</u>	Bid Item #2. Cummins 2013 ISL-9 Protection Plan 1, Five Years 100,000 Miles. Coverage is 100 percent parts and labor with no deductibles on internally lubricated components and major engine systems including turbo charger, water pump, and fuel injectors Bid Item # 3. Cummins 2013 ISL-9 After Treatment Plan: Coverage (5/100) Five Years/100,000 Miles. Coverage is 100 percent parts and labor with no deductibles on the DEF controller/ dosing unit/dosing valve, SCR catalyst, catalytic converter particulate filter, SCR/DPF temperature sensor interface module and other related after treatment parts detailed in Cummins Bulletin #3381446	Meets Meets
22.		Two (2) year manufacturer warranty from date of in-service, to include towing if necessary. Lake County in service date is considered the day the vehicle is built to its intended purpose. Company to provide in house factory warranty training to Lake County service technicians for all components The winning bidder shall meet at Lake County DOT at a determined date and time by mutual agreement for a pre build meeting. The winning bidder shall provide a detailed Autocad drawing layout of the Cab, Frame, chassis, and other major components. These components shall consist of but are not limited to, the fuel tank, DEF and emission components, air tanks, battery boxes and filter housings. The manufacture shall have the ability to relocate such components as specified by Lake County D.O.T. at the manufacturer's location prior to deliver. 3 Sets of keys	Meets ↓

GENERAL TERMS AND CONDITIONS

Bid #15015

January 2015

Purchase of (4) Snow Plow Trucks for the Lake County Division of Transportation, Libertyville, IL

1. OVERVIEW

Lake County intends to purchase four (4) new, unused, 2016 Snow Plow Trucks, as specified herein. Trucks will be furnished as specified and with manufacturer's standard equipment that is normally supplied, whether itemized or not, to provide a complete and fully functional truck. Bidder's must meet or exceed all of the specifications for all items as described herein. In the past (2) two years, Lake County has purchased (5) five Peterbilt, Model 348, Tandem Rear Axle Trucks, with extended cabs. Lake County also owns fifteen (15) International Trucks, Models 7600 and 2674, four (4) Freightliner Trucks, Models 114SD and M2 1124V, and one (1) Peterbilt Truck, Model 367. Lake County's intent is to purchase vehicles which meet or exceed the specifications of these models. The specified equipment will be furnished and delivered to the specified Lake County location, with all freight and delivery charges included in the bid price.

Lake County Division of Transportation
Maintenance Division
600 West Winchester Road
Libertyville, IL 60048

2. WORK INCLUDED

The work to be performed by the Contractor shall include furnishing and delivering the awarded items.

3. SUBMISSION OF BIDS

Bids will be accepted until **2:00 p.m. local time, February 12, 2015**, at the Lake County Purchasing Division, 18 North County Street, 9th Floor; Waukegan, IL 60085-4350. Each bid must include the following completed and signed forms and submissions:

- a. One (1) original "Invitation to Bid" including signed forms, Bid Sheet.
- b. One (1) electronic copy of the complete bid submission, on a CD or flash drive.
- c. Compliance with Specifications Sheets, pages 15 - 21, with compliance to each specification section indicated.
- d. One (1) Addendum Acknowledgement, if appropriate, page 22.
- e. One (1) Contractor Qualification Form, pages 23 and 24.
- f. Bidders shall complete and submit a Statement of Sustainability to ensure bidders are incorporating sustainability into their firm's practices. Appendix A is included herein for this purpose, page 26.
- g. One (1) Reference Sheet, page 27.
- h. One (1) Equipment Capability Form, page 28.
- i. Product literature and manufacturer's specifications for all items bid.

4. PRE-BID CONFERENCE

A Pre-Bid conference will be held on January 23, 2015 at 9:00 a.m. local time at the Lake County Division of Transportation, Conference Room, 600 W. Winchester Road, Libertyville, IL 60048. Attendance at this meeting is not mandatory; however, Contractors are warned that no allowance will be granted to bidders unfamiliar with the requirements of this bid.

5. PRODUCT SUPPLIED

All equipment will be new (recent manufacture or manufactured for this contract) and unused, first quality only. Equipment supplied will conform in quality, construction, fit for intended use and meet all industry standards for the intended use as specified herein. Please include product descriptive literature and specification sheets with the bid submission.

6. AWARD

Award will be made to the lowest responsive and responsible bidder, for the Base Bid amount, who best meets the evaluation criteria specified herein.

7. PRECEDENCE

Where there appears to be variances or conflicts, the following order of precedence shall prevail: Lake County Specifications; Lake County General Terms & Conditions, Lake County Invitation for Bids General Terms & Conditions and the Contractor's Bid Response.

8. ESTIMATED QUANTITY

The quantities listed on the bid cover sheets are estimates of the total quantity to be used during the year. The County does not guarantee any specific amount and shall not be held responsible for any deviation. This contract shall cover the County's requirements whether more or less than the estimated amount.

9. BID PRICE

Pricing is to be submitted for the provision and delivery of all equipment as per specifications. The bid price shall be the net price charged per item; F. O. B. delivered, freight prepaid and included in the bid price to Lake County, including all discounts. The price bid for each item is the full purchase price, including delivery to destination, and shall include all labor, and equipment used in delivery, and includes but is not limited to:

- All transportation charges to and from destination.
- All premiums on insurance, bonds, material or service costs.
- All current or future surcharges on fuel or any other commodity.
- All other overhead charges of every kind and nature

10. CONTRACTOR QUALIFICATIONS AND EVALUATION CRITERIA

All bidders shall be original equipment manufacturer authorized dealers/distributors for state and local governments, and must be able to provide supporting documentation at the County's request in order to be considered for award. All bidders must be qualified suppliers and demonstrate their capability to provide products required in accordance with the bid specifications. Bidders shall complete and submit the Contractors Qualification Form with their bid.

Bids shall be evaluated as follows: (not listed in order of priority):

- Bid price
- Compliance with the specifications as set forth herein. Bidders shall include an additional page (s) listing any non-compliance to the specifications. If any non-compliance to the specifications exists, Bidders shall insert an "X" in the Exception box on the Bid Sheet, Page 3.
- Compliance with the delivery requirements
- References provided where similar equipment is installed and is being used
- Number of years in business
- Technical and services capabilities of Contractor's employees
- Quality of construction, durability and life expectancy of the system

11. SPARE PARTS

Contractor shall have sufficient inventory of wear items and other spare parts at their location to guarantee delivery to the Purchaser's Libertyville, Illinois facility within twenty four (24) hours after receipt of purchase order.

12. DELIVERY REQUIREMENTS

The required products shall be delivered to the specified Lake County location within sixty (60) days of receipt of purchase order.

13. DELIVERY CONDITIONS

Specified equipment shall be bid F.O.B. Destination, with all freight and transportation charges included in the bid price.

The term F.O.B. Destination shall mean delivered to a specified Lake County location. Any claim for loss or damage shall be between the Contractor and the carriers, movers, riggers, etc.

14. OPERATION MANUALS

Successful contractor shall furnish one (1) copy of a detailed shop manual, operating manual, and a service and parts manual, including all components and accessories. Manuals may be furnished electronically on a CD or may be accessed on-line, if all the same information is available on a web-site.

15. INVOICES AND PAYMENTS

The Contractor shall submit an invoice(s) detailing the services and products provided in accordance with the payment provisions of this contract. Invoice shall show the purchase order number and the address where the product or service was provided. Payment shall be made in accordance with the Local Government Prompt Payment Act.

16. BID REVIEW

After bid submittal, bids may be subjected to subsequent review. Lake County reserves the right to conduct follow up reference checks, request additional information or perform other activities related to comprehensive bid review and determination of the lowest responsive and responsible bidder who best meets the specifications.

17. NON-ENFORCEMENT BY THE COUNTY

The Contractor shall not be excused from complying with any of the requirements of the contract because of any failure on the part of the County, on any one or more occasions, to insist on the Contractor's performance or to seek the Contractor's compliance with any one or more of said terms or conditions.

18. REFERENCES

References must be provided as requested on the Reference Page. Bidders shall complete and submit the Reference Form with their bid.

19. UNBALANCED BIDDING

Bidders shall not submit a bid, which contains irregularities of any kind, including unbalanced bids. By an unbalanced bid, it is meant that one or more separate items are substantially out of line with the price for other comparable items. The County reserves the right not to award any items whose unit discount rates appear excessive or unbalanced.

20. TERMINATION

The County reserves the right to terminate this contract, or any part of this contract, upon thirty (30) days' written notice. In case of such termination, the Contractor shall be entitled to receive payment from the County for fuel delivered or in transit to date in accordance with the terms and conditions of this contract. In the event that this contract is terminated due to Contractor's default, the County shall be entitled to purchase substitute items and/or services elsewhere and charge the Contractor with any or all losses incurred, including attorney's fees and expenses.

21. CHANGE IN STATUS

The Contractor shall notify Lake County immediately of any change in its status resulting from any of the following: (a) vendor is acquired by another party; (b) vendor becomes insolvent; (c) vendor, voluntary or by operation law, becomes subject to the provisions of any chapter of the Bankruptcy Act; (d) vendor ceases to conduct its operations in normal course of business. Lake County shall have the option to terminate its contract with the vendor on 15 days written notice based on any such change in status.

22. PRECEDENCE

Where there appears to be variances or conflicts, the following order of precedence shall prevail: Lake County General Terms and Conditions, Lake County Invitation for Bids General Terms and Conditions, Lake County's Specifications, and the Contractor's Bid Response.

23. MOST FAVORED CUSTOMER

The Contractor guarantees that the prices covered by this contract shall be the lowest prices offered to any customer for similar goods/services during the period of this contract. If the Contractor offers lower prices or new rate plans for similar goods/services to any other customer during the contract period, then these lower prices shall be offered to Lake County, and the contract shall be modified accordingly.

24. RESERVED RIGHTS

Lake County reserves the right to cancel this Invitation for Bid at any time, to reject any and all bids for any reason, to accept an alternate bid, to waive any informalities or exceptions in the bid and to award on a collective or individual item basis.

25. HOLD HARMLESS CLAUSE

The Contractor agrees to indemnify, save harmless and defend Lake County, its agents, servants, employees, and each of them against and hold it and them harmless from any and all lawsuits, claims, demands, liabilities, losses, and expenses; including court costs and attorney's fees for or on account of any injury to any person, or any death at any time resulting from such injury, or any damage to property, which may arise or which may be alleged to have arisen out of, or in connection with the work covered by this project. The foregoing indemnity shall apply except if such injury is caused directly by the willful and wanton conduct of Lake County, its agents, servants, or employees or any other person indemnified hereafter.

26. INSURANCEAll Contracts may be subject to change

The contractor must obtain, for the Contract term and any extension of it, insurance issued by a company or companies qualified to do business in the State of Illinois with an A.M. Best Rating of at least A-. Insurance in the following types and amounts is necessary:

Workers Compensation (Coverage A) and Employers Liability (Coverage B)

Workers Compensation Insurance covering all liability of the Contractor arising under the Worker's Compensation Act and Worker's Occupational Disease Act at limits in accordance with the laws of the State of Illinois. Employers' Liability Insurance shall be maintained to respond to claims for damages because of bodily injury, occupational sickness, or disease or death of the Contractor's employees, with limits listed below:

Employers Liability

- a) Each Accident \$1,000,000
- b) Disease-Policy Limit \$1,000,000
- c) Disease-Each Employee \$1,000,000

Such insurance shall contain a waiver of subrogation in favor of Lake County.

Commercial General Liability Insurance

In a broad form on an occurrence basis shall be maintained, to include, but not be limited to, coverage for property damage, bodily injury (including death), personal injury and advertising injury in the following coverage forms where exposure exists:

- Premises and Operations
- Independent Contractors
- Products/Completed Operations
- Liability assumed under an Insured Contract/ Contractual Liability
- Personal Injury and Advertising Injury

With limits of liability not less than:

\$ 1,000,000 Each Occurrence

\$ 1,000,000 Products-Completed Operations

\$ 1,000,000 Personal and Advertising injury limit

\$ 2,000,000 General aggregate; the CGL policy shall be endorsed to provide that the General Aggregate limit applies separately to each of the contractor's projects away from premises owned or rented to contractor.

Automobile Liability Insurance

Automobile liability insurance shall be maintained to respond to claims for damages because of bodily injury, death of a person, or property damage arising out of ownership, maintenance, or use of a motor vehicle. This policy shall be written to cover any auto whether owned, leased, hired, or borrowed. This policy must provide property damage and bodily injury coverage for the County's vehicle while the vehicle is under the possession and/or control of Contractor during warranty service and/or repairs or maintenance and where the County's vehicle is under the possession and/or control of Contractor while the County's vehicle is being transported for delivery or service. The Contractor's auto liability insurance, as required above, shall be written with limits of insurance not less than the following:

\$ 1,000,000 Combined single Limit (Each Accident)

Excess/ Umbrella Liability

The Contractor's Excess/ Umbrella liability insurance shall be written with the umbrella follow form and outline the underlying coverage, limits of insurance will be:

\$ 10,000,000 per occurrence limit

Contractor agrees that with respect to the above required insurance:

- a) The CGL policy shall be endorsed for the general aggregate to apply on a "per Project" basis;
- b) The Contractor's insurance shall be primary in the event of a claim.
- c) Contractor agrees that with respect to the above required insurance, Lake County shall be named as additional insured, including its agents, officers, and employees and be provided with thirty (30) days' notice, in writing by endorsement, of cancellation or material change;
- d) Lake County shall be provided with Certificates of Insurance and endorsements evidencing the above required insurance, prior to commencement of this Contract, and thereafter annually for contracts/ projects that will last more than one year. The Contractor shall further provide Lake County with certificates evidencing renewals or replacements of said policies of insurance at least thirty (30) days prior to the expiration of cancellation of any such policies. Said Notices and Certificates of Insurance shall be provided to:

**Lake County
Purchasing Division
18 N. County 9th Floor
Waukegan, Illinois 60085
Attn: RuthAnne Hall, Lake County Purchasing Agent**

Failure to Comply: In the event the Contractor fails to obtain or maintain any insurance coverage required under this agreement, the Lake County may purchase such insurance coverage and charge the Expense thereof to the Contractor.

27. INDEPENDENT CONTRACTOR

The Contractor is an independent contractor and no employee or agent of the Contractor shall be deemed for any reason to be an employee or agent of Lake County.

31. REPORTING REQUIREMENTS FOR AWARDED CONTRACTS

All awarded vendors will identify and report the type of ownership— L/W/MBE, and/or not L/W/MBE for any work that they or their approved subcontractors will perform. In addition, Lake County requests that all awarded vendors provide an accounting of employees assigned throughout the term of the contract in regards to their home address and ethnicity. Lake County may use any data collected to report on potential of businesses and workers benefitting from County contracts.

32. SUSTAINABILTY STATEMENT

Lake County is committed to green and sustainable practices and good environmental stewardship. Consequently, we are asking bidders to provide a Statement of Sustainability to ensure our bidders are also incorporating sustainability into their firms' practices. Please complete Appendix A, included herein, and include it with the bidder's submission.

33. ADDITIONAL INFORMATION

Should the bidder require additional information about this bid, please submit questions on our website at <http://lakecountypurchasingportal.com> by selecting the bid number and addendum link. Questions may also be submitted via email to purchasing@lakecountyl.gov. All questions shall be submitted no less than seven (7) days prior to the bid opening date. ANY and ALL changes to these specifications are valid only if included in an addendum issued by Lake County Purchasing. No interpretation of the meaning of the plans, specifications or other contract documents will be made orally. Failure of any bidder to receive any such addendum or interpretation shall not relieve the bidder from obligation under this bid as submitted. All addenda as issued shall become part of the bid documents. Failure to request an interpretation constitutes a waiver to later claim that ambiguities or misunderstandings caused a bidder to improperly submit a bid.

34. ADDENDUM ACKNOWLEDGEMENT

Any and all changes to the specifications, terms, and conditions of this Bid are valid only if they are included by addendum issued by Lake County Purchasing. Bidders shall acknowledge addenda by signing the enclosed Addendum Acknowledgement form. It is the vendor's responsibility to check for addendums, posted on the website at <http://lakecountypurchasingportal.com> prior to the submittal due date. No notification will be sent when addendums are posted unless there is an addendum within three business days of the submittal due date.

35. REPORT OF CONTRACT PURCHASES

Contractor shall furnish a report of purchases made from the contract by the fifteenth (15) of the month following the end of each contract quarter. The report will be broken down by each Department. The report is to be submitted to the Purchasing Division, 18 N. County Street - 9th Floor, Waukegan, Illinois 60085 and to each individual Department, and shall include the contract number, title, effective dates, contractor's name, and the following information:

Ordering Agency	Description of Item or Service Provided	Quantity provided	Price for Item or Service	Extended Price
-----------------	--	-------------------	------------------------------	----------------

Failure to submit the required reports may be cause for disqualification of the contractor for future contracts.

36. EQUALITY

Whenever these specifications mention an item by name and use specific descriptions as refers thereto, it is intended to convey to the bidder an understanding of the standard of excellence required. Items of equal type, quality, and size, which will conform substantially to the standard of excellence, established to provide equivalent merit, strength, durability, and to perform the required function in accordance with these specifications may be offered. Manufacturer/model names provided in this bid specifications herein convey the standard and uniformity the Lake County demands. If bidding brands other than specified, product documentation must be submitted with your bid. Lake County shall make the final determination as to whether a substitute item is equal to the item specified.

37. WARRANTY TERM, SERVICE AND SUPPORT

All equipment included in this bid shall be warranted to be free from defects for a two (2) year period, 100% parts and labor, or for the manufacturer's standard warranty, whichever is longer. The warranty period shall end two (2) years after the vehicle "in-service" date, not the delivery date to Lake County. The Contractor awarded this contract must agree to respond to concerns within twenty-four (24) hours and guarantee repair within five (5) days. During the warranty period, the Contractor shall be responsible to provide all preventive services suggested by the manufacturer.

END OF GENERAL TERMS AND CONDITIONS



535 E. South Frontage Rd / Bolingbrook, IL / 60440

Date : 2-27-2016

To: Village of Downers Grove
801 Burlington Ave
Downers Grove , IL. 60515
Vinney Pasquinelli

Dear Vinny,

JX Peterbilt is pleased to present a price quotation for (3) New 2017 Peterbilt Model 348 cab and chassis with the enclosed specifications.

Peterbilt Model 348 Cab and Chassis as per attached specifications

LAKE COUNTY Joint Purchase Agreement # 15015

2017 Cab and Chassis	\$ 98,216.05
Lindco Equipment as per attached	\$ 96,654.00
5 year Engine and After Treatment Warranty	\$ 2,750.00
3 year / 100 Basic Chassis Warranty	\$ 1,320.00
Doc Fee / Plates / Title Transfer	\$ 273.00
TOTAL Sale Each	\$ 199,213.05
LESS 2001 FL-80 Trade In	\$ <10,000.00>
TOTAL	\$ 189,213.05 each

TOTAL (3) Units \$ 567,639.15

OPTION

Upgrade from 100 gallon dual pre wet tanks to 160 Add \$ 1025.00 Each

Above Price ONLY good for orders place before March 28th, 2016

Rick Michalowski | Vocational Account Manager

JX Enterprises, Inc.

Cell 708-207-2354 | Fax 708-460-8991

rmichalowski@jxe.com

www.JXE.com

LINDCO

Equipment Sales, Inc.

2168 East 88th Drive
Merrillville, IN 46410
USA

QUOTATION

Quote Number: 160199
Quote Date: Feb 11, 2016
Page: 1

Voice: (219)795-1448
Fax: (219)736-0892

**Visit Lindco's new webstore @ www.lindco-usa.com
Now accepting Visa and Mastercard**

Quoted To:
Downers Grove, Village of 801 Burlington Avenue Downers Grove, IL 60515 USA

Customer ID	Good Thru	Payment Terms	Sales Rep
Downers Grove-01	3/12/16	Net 30 Days	35878

Quantity	Item	Description	Unit Price	Amount
1.00	ABB-DA-13-201SS-DG	EQUIPMENT FOR TANDEM AXLE PLOW TRUCK THE FOLLOWING ITEMS MUST BE FURNISHED BY THE TRUCK MANUFACTURER: * FRONT FRAME EXTENSIONS. * CHASSIS BODY BUILDER WIRING HARNESS TO END OF TRUCK FRAME. * CHASSIS PLOW LIGHT HARNESS WITH SWITCH IN DASH * 120" CAB TO TRUNNION * WIRE FOR HOOKING UP GROUND SPEED * BUCKET SEATS IN CAB * MINIMUM OF 22" CLEARANCE UNDER CAB AND BACK TO REAR AXLE ON BOTH SIDES. * MINIMUM OF 46" CLEARANCE FROM BACK OF CAB TO REAR FRONT SPRING SHACKLE ALONG FRAME ON DRIVE SIDE * HORIZONTAL EXHAUST WITH VERTICAL STACK ON CURBSIDE * TRANS DIPSTICK LOCATED ON PASSENGER SIDE. Swenson 13'L, Dual Auger APB all purpose body, 40" sides, 50" TG, sloped sides, 7 ga. 201 SS construction, dual 7" augers, DA TG spinner assy. w/poly disc, * 13' long * 84" wide I.D.	34,545.05	34,545.05

Quote valid for 30 days.

Subtotal	Continued
Sales Tax	Continued
TOTAL	Continued

LINDCO

Equipment Sales, Inc.

2168 East 88th Drive
Merrillville, IN 46410
USA

QUOTATION

Quote Number: 160199
Quote Date: Feb 11, 2016
Page: 2

Voice: (219)795-1448
Fax: (219)736-0892

**Visit Lindco's new webstore @ www.lindco-usa.com
Now accepting Visa and Mastercard**

Quoted To:
Downers Grove, Village of 801 Burlington Avenue Downers Grove, IL 60515 USA

Customer ID	Good Thru	Payment Terms	Sales Rep
Downers Grove-01	3/12/16	Net 30 Days	35878

Quantity	Item	Description	Unit Price	Amount
		<ul style="list-style-type: none"> * 96" wide O.D. * 48" high front wall * 40" high sides * 50" high tailgate * 8.5 cu. yard capacity * 3/16 (201 SS) construction * 201 SS auger cover plate on floor * Air release double-acting tailgate (201 SS) w/SS hardware. * 1/2 cab shield (201 SS), fully enclosed w/16 total ovals total facing front, back & side. * 38 degree sloping sides * Dual 7" augers * DA TG spinner assembly w/poly disc * Crossmemberless understructure * Telescopic front mounted hoist, double-acting (power up & power down) * Grease extensions * Dual 100 gallon prewet tanks w/cross over mounted to sides of body * 1-1/2" quick fill kit * Prewet pump flush kit * Three (3) coal chute doors installed in tailgate * Body hoist prop * Grab handle at front on driver side (201 SS) * Stainless steel fold up ladder on driverside 		

Quote valid for 30 days.

Subtotal	Continued
Sales Tax	Continued
TOTAL	Continued

LINDCO

Equipment Sales, Inc.

2168 East 88th Drive
Merrillville, IN 46410
USA

QUOTATION

Quote Number: 160199
Quote Date: Feb 11, 2016
Page: 3

Voice: (219)795-1448
Fax: (219)736-0892

**Visit Lindco's new webstore @ www.lindco-usa.com
Now accepting Visa and Mastercard**

Quoted To:
Downers Grove, Village of 801 Burlington Avenue Downers Grove, IL 60515 USA

Customer ID	Good Thru	Payment Terms	Sales Rep
Downers Grove-01	3/12/16	Net 30 Days	35878

Quantity	Item	Description	Unit Price	Amount
1.00		* Stainless steel handles on upper tailgate pins		
1.00		* Stainless steel tailgate chains		
1.00		* Special stainless steel custom light boxes on each corner post w/(3) oval cutouts for lighting, (1) oval on side of box.		
1.00		* All SS TG hardware & linkage		
1.00	322418R	Lindco 10" high oak side boards, painted BLACK		
1.00		DuraGuard 3/8" HD 24" x 18" Poly Guard Mud Flap - Black - with Lindco Equipment Sales, Inc. Logo & Merrillville, IN molded blue/white into flap (price per pair)	14.43	14.43
2.00	MFW2375-SS	Lindco Mud Flap Bolting Plate-Stainless Steel (Each)	21.56	43.12
1.00	PF400-132X	Life-Time poly full fenders for tandem.	717.79	717.79
1.00	K4363US	Life-Time full fenders stainless mounting kit for tandem axle chassis.	391.38	391.38
1.00	510	Ecco back-up alarm, 97 dB, 12 VDC.	18.39	18.39
1.00		Reflective tape on sides & tailgate		
1.00		* LED S/T/T lights, ICC lights, reflectors and harness		
1.00		Aero EZ Pull tarp system w/asphalt tarp and aluminum housing.	893.75	893.75
1.00	DC-3200	Cougar Dump Body Vibrator 12 volt DC, 3200 lbs of force, 85 amps, 4000 RPM, Includes mounting kit, wiring kit, switch	761.25	761.25
2.00	T1903595	ALT 6" oval backup, class 1 LED. Includes grommet & pigtail.	25.00	50.00
18.00	F1914101	ALT 6" oval amber, class 1 LED. Includes grommet &	28.75	517.50

Quote valid for 30 days.

Subtotal	Continued
Sales Tax	Continued
TOTAL	Continued

LINDCO

Equipment Sales, Inc.

2168 East 88th Drive
Merrillville, IN 46410
USA

QUOTATION

Quote Number: 160199
Quote Date: Feb 11, 2016
Page: 4

Voice: (219)795-1448
Fax: (219)736-0892

Visit Lindco's new webstore @ www.lindco-usa.com
Now accepting Visa and Mastercard

Quoted To:

Downers Grove, Village of
801 Burlington Avenue
Downers Grove, IL 60515
USA

Customer ID	Good Thru	Payment Terms	Sales Rep
Downers Grove-01	3/12/16	Net 30 Days	35878

Quantity	Item	Description	Unit Price	Amount
1.00	996174051	pigtail. Hella C220 combination plow lamp, LH pedestal surface, stud mount.	84.49	84.49
1.00	996174061	Hella C220 combination plow lamp, RH pedestal surface, stud mount.	84.49	84.49
2.00	H84985451	Hella pigtail 355mm w/6 pin DT connector.	8.93	17.86
1.00	PLB11SS	Buyers stainless steel plow light brackets.	81.51	81.51
2.00	W0904500	ALT LED worklight, Par36, 27 watts, 2150 Lumen, black aluminum housing, SPOT light.	36.88	73.76
1.00	SWM 43C	Preco Switch, water resistant, 5 amp rating, 360 degree movement, can be wired open or closed, maded of ABS plastic, adjustable mounting bracket.	28.83	28.83
2.00	055060	Velvac Electrical Junction Box	8.80	17.60
1.00	131-0011	TST 80 amp high amp circuit breaker.	45.22	45.22
1.00		Box in rear frame rails, no pintle hook		
1.00	49122	Grote SuperNova thin-line LED red bar lamps.	47.73	47.73
1.00	60321	Grote license lamp w/stainless steel bracket.	15.49	15.49
1.00	B2800A	Buyers Heavy Duty Tow Hooks (27,000# capacity) - Pair	37.21	37.21
1.00	CPTO 280GGFJW-B8RF	Chelsea Hot Shift Wet Spline PTO for direct mounted pump with rotating flange	1,576.93	1,576.93
1.00	SDPP 83027121	Certified Power Pump Load Sensing Pump JR-R-S75C-LS-14-24-NN-N-3-A3NH DBN-NNN-JJJ-NNN (WET SPLINE)	1,500.48	1,500.48
1.00	RESE MTCA3301000106	Certified Power 3 spool manual PVG32, SS reservoir/valve assembly with auger/spinner/prewet.	5,763.00	5,763.00

Quote valid for 30 days.

Subtotal	Continued
Sales Tax	Continued
TOTAL	Continued

LINDCO

Equipment Sales, Inc.

2168 East 88th Drive
Merrillville, IN 46410
USA

QUOTATION

Quote Number: 160199
Quote Date: Feb 11, 2016
Page: 5

Voice: (219)795-1448
Fax: (219)736-0892

Visit Lindco's new webstore @ www.lindco-usa.com
Now accepting Visa and Mastercard

Quoted To:

Downers Grove, Village of
801 Burlington Avenue
Downers Grove, IL 60515
USA

Customer ID	Good Thru	Payment Terms	Sales Rep
Downers Grove-01	3/12/16	Net 30 Days	35878

Quantity	Item	Description	Unit Price	Amount
1.00	HBV200	Buyers 2" Ball Valve - Full Flow	54.06	54.06
1.00	ELCA F22Spreader	Certified Power Freedom 2.2 spreader control	982.58	982.58
1.00	ELCA SG07010468-001	Certified Power Freedom 2 mounting bracket	21.05	21.05
3.00	ELCA SG07050722-002	Certified Power MFE ST/ST BPM 5 meter	121.49	364.47
1.00	ELCA SG07050731-002	Certified Power MFE ST/ST 5 meter wiring harness	70.95	70.95
1.00	ELCA SG07050638	Certified Power harness male 21' to splitter 2.	79.18	79.18
1.00	ELCA SG07050316	Certified Power pre-wet float switch harness 2.5 meter.	46.81	46.81
1.00	ELCA SG07051073	Certified Power F21-F22 main harness	233.81	233.81
3.00	WESC 51461-096I	Certified Power 8' RVC Cable.	27.41	82.23
1.00	WESC 08-5920-06-R	Wescon dual axis control w/one (1) momentary blast button & one (1) momentary spot button.	210.00	210.00
1.00	WESC 08-6002-02	Wescon Single Axis Control w/center locking & 70 degree offset.	48.68	48.68
1.00	2001370	TST Control Console Panel Assembly with Back Lighting. Switches for Plow lights, Pump, Top Warn Light, Rear Warn Light, Spreader Lit, Aux. & Body up Light	526.97	526.97
1.00	9800576-1	TST Control Console Panel Assembly 2-5/8" Spacer	20.77	20.77
1.00	9800576-2	TST Control Console Panel Assembly 1-3/16" Spacer	11.53	11.53
3.00	RESE MT03139516	Certified Power PVG32 Clevis Kit for valve/service guard	16.06	48.18
1.00	MORS RVC-DECAL-1	Morse control decal for CT-SA-1 & CT-DA-2	1.30	1.30
1.00	LISC SG06070056-3	Certified Power prewet, valve instack w/flow meter with stainless bracket	1,662.50	1,662.50
1.00	LISC SG06090034	Certified Power prewet plumbing kit. Includes hoses, all fittings, check valve nozzles, etc.	326.25	326.25

Quote valid for 30 days.

Subtotal	Continued
Sales Tax	Continued
TOTAL	Continued

LINDCO

Equipment Sales, Inc.

2168 East 88th Drive
Merrillville, IN 46410
USA

QUOTATION

Quote Number: 160199
Quote Date: Feb 11, 2016
Page: 6

Voice: (219)795-1448
Fax: (219)736-0892

**Visit Lindco's new webstore @ www.lindco-usa.com
Now accepting Visa and Mastercard**

Quoted To:
Downers Grove, Village of 801 Burlington Avenue Downers Grove, IL 60515 USA

Customer ID	Good Thru	Payment Terms	Sales Rep
Downers Grove-01	3/12/16	Net 30 Days	35878

Quantity	Item	Description	Unit Price	Amount
1.00	ELCA SG07050245	Certified Power harness, 90 DEC, 8.2' Auger Sensorw/cap, BH	68.68	68.68
1.00	ELCA SG07070122	Certified Power Poly Float with BH Corded Plug	48.63	48.63
1.00	ELCA SG07010269	Certified Power Low oil shutdown kit for PTO	412.28	412.28
1.00	PFC10-RC-30-12D-DN-S	Certified Power comatrol proportional valve.	238.41	238.41
1.00	LISC SG06010092	Certified Power single lane stainless steel spray boom with nozzles and plumbing kit	1,250.00	1,250.00
2.00	RT25810	Buyers Receiver Tube 2" I.D. x 10"	14.45	28.90
2.00	HP6253WC	Buyers Hitch Pin Assembly	2.01	4.02
1.00	LISC SG06090013	Certified Power prewet quick release kit w/ 1/2" hose.	24.80	24.80
1.00	ELCA 849-1262-003	Certified Power "Roadwatch" kit sensor & display.	844.95	844.95
1.00	00002 332 39	Swenson V-box flush kit	226.62	226.62
1.00	00002 332 11	Swenson 2" female quick fill kit	83.66	83.66
1.00		Hoses & fittings, Stainless tubing to front & stainless tubing to rear. PLOW COUPLING SYSTEM	1,750.00	1,750.00
1.00	10-932-4001	CEJN Multi-X Quattro 12.5 Female Plate, 4 port, WEO 3/4" connection, 1/2" nominal flow diameter, dust caps, and , mounting bracket	314.31	314.31
1.00	10-932-4051	CEJN Multi-X Quattro 12.5 Male Plate, 4 port, WEO 1/2" connection, 1/2" nominal flow diameter, dust caps, and , mounting bracket	267.50	267.50
4.00	14-727-0812	CEJN Multi-X adapter 1/2" WEO to male JIC 3/4"-16	8.15	32.60
4.00	14-727-1217	CEJN Multi-X adapter 3/4" WEO to male JIC 1-1/16"-12	10.05	40.20
1.00	10-932-1023	CEJN Multi-X Quattro aluminum cover/parking dock,	87.69	87.69

Quote valid for 30 days.

Subtotal	Continued
Sales Tax	Continued
TOTAL	Continued

LINDCO

Equipment Sales, Inc.

2168 East 88th Drive
Merrillville, IN 46410
USA

QUOTATION

Quote Number: 160199
Quote Date: Feb 11, 2016
Page: 7

Voice: (219)795-1448
Fax: (219)736-0892

**Visit Lindco's new webstore @ www.lindco-usa.com
Now accepting Visa and Mastercard**

Quoted To:
Downers Grove, Village of 801 Burlington Avenue Downers Grove, IL 60515 USA

Customer ID	Good Thru	Payment Terms	Sales Rep
Downers Grove-01	3/12/16	Net 30 Days	35878

Quantity	Item	Description	Unit Price	Amount
1.00	10-932-1074	female CEJN Multi-X Quattro aluminum cover/parking dock with mounting bracket, male	100.31	100.31
1.00	10-932-2001	SPINNER COUPLING SYSTEM CEJN Multi-X Duo 12.5 female plate, 2 ports, 1/2".	267.79	267.79
1.00	10-932-2051	CEJN Multi-X Duo 12.5 Male plate, 2 ports, 1/2". *AUGER TO USE REGULAR HYDRAULIC FITTINGS SINCE IT IS A COMBINATION BODY.	220.93	220.93
40.00	Hydraulic Oil	Hydraulic Oil	9.69	387.60
1.00		Reuse Peterbilt bumper		
1.00		Wausau SQH Arrangement for HomeSafe plow consisting of plow frame, SQH plow hitch angling w/poly wear pads, lift cylinder, truck plate w/quick release. *Reuse existing Wausau HomeSafe plow and convert to SQH.	9,715.00	9,715.00
2.00	W4P03596	Schmidt "Z" bracket-connect frame to plow 3.25" x 5.5" x 1/2" thick (Each)	26.44	52.88
1.00	3512144	"Lindco" Snow Deflector 12"	63.33	63.33
1.00	A3397	Brigade color camera kit complete with VBV-770D-000N 7" LCD color monitor, VBV-701C color camera and 66' cable	495.01	495.01
1.00	A1386	Brigade 33' camera cable	14.06	14.06
1.00	MSF8470037000	Camera Wash (1) nozzle	293.75	293.75
1.00	MSF5000CAM "U"	Camera box for camera stainless steel w/"U" pivot bracket.	169.64	169.64

Quote valid for 30 days.

Subtotal	Continued
Sales Tax	Continued
TOTAL	Continued

LINDCO

Equipment Sales, Inc.

2168 East 88th Drive
Merrillville, IN 46410
USA

QUOTATION

Quote Number: 160199
Quote Date: Feb 11, 2016
Page: 8

Voice: (219)795-1448
Fax: (219)736-0892

**Visit Lindco's new webstore @ www.lindco-usa.com
Now accepting Visa and Mastercard**

Quoted To:
Downers Grove, Village of 801 Burlington Avenue Downers Grove, IL 60515 USA

Customer ID	Good Thru	Payment Terms	Sales Rep
Downers Grove-01	3/12/16	Net 30 Days	35878

Quantity	Item	Description	Unit Price	Amount
1.00	MSF5010	Camera Wash 30' tubing kit complete with air and washer	54.08	54.08
1.00	PAINT HOIST & SUBFRA	Prime Where needed and Paint Hoist & Subframe to black	194.12	194.12
1.00	PAINT PLOW HITCH	Paint Plow Hitch, Including lift arm, side plates, bumper and lift cylinder black	205.89	205.89
1.00	PAINT-MISCEL	Paint Miscel	147.06	147.06
1.00	Under Coat	Under coat dump body	170.00	170.00
2,300.72	Misc.	Miscellaneous Material - includes any or all of the following: wiring, electrical connectors, tie downs, clamps, nut, bolts, washers, steel, oil, grease, etc.	1.00	2,300.72
2,450.00	FREIGHT	FREIGHT	1.00	2,450.00
239.00	INSTALLATION	Lindco Installation Labor Hours	90.00	21,510.00
<p>*ALL ITEMS PAINTED AND MOUNTED COMPLETE.</p> <p>DELIVERY NOTES:</p> <p>ALLOW 90-120 DAYS FOR EQUIPMENT TO BE INSTOCK, ONCE RECEIVING PURCHASE ORDER FOR TRUCK DEALER.</p> <p>ALLOW 60-90 DAYS TO COMPLETE ALL UNITS, ONCE ALL EQUIPMENT AND CHASSIS ARE INSTOCK AT LINDCO.</p> <p>TOTAL DELIVERY TIME, INCLUDING RECEIVING EQUIPMENT IN STOCK, COULD RANGE FROM 120-180 DAYS, DEPENDING ON TIME OF YEAR CHASSIS ARRIVES AT LINDCO.</p> <p>PRICING DOES NOT INCLUDE PICKUP OR</p>				

Quote valid for 30 days.

Subtotal	Continued
Sales Tax	Continued
TOTAL	Continued

LINDCO

Equipment Sales, Inc.

2168 East 88th Drive
Merrillville, IN 46410
USA

Voice: (219)795-1448
Fax: (219)736-0892

QUOTATION

Quote Number: 160199
Quote Date: Feb 11, 2016
Page: 9

Visit Lindco's new webstore @ www.lindco-usa.com
Now accepting Visa and Mastercard

Quoted To:

Downers Grove, Village of
801 Burlington Avenue
Downers Grove, IL 60515
USA

Customer ID	Good Thru	Payment Terms	Sales Rep
Downers Grove-01	3/12/16	Net 30 Days	35878

Quantity	Item	Description	Unit Price	Amount
1.00		DELIVERY OF THE TRUCK. OPTIONAL ITEMS: To upgrade to dual 160 gallon prewet tanks in lieu of dual 100 gallon tanks, ADD \$1,025.00.		

Quote valid for 30 days.

Subtotal	96,654.00
Sales Tax	
TOTAL	96,654.00

PETERBILT

JX Peterbilt - Bolingbrook P128
535 E South Frontage Rd

Village of Downers Grove
801 Burlington Ave

Bolingbrook, Illinois United States 60440

Downers Grove, Illinois United States 60515

Phone: (630) 972-2720

Phone:

Fax: (630) 972-2721

Fax:

Email:

Contact Email:

Prepared for:

Vehicle Summary

	Unit		Chassis	
Model:		Model 348	Fr Axle Load (lbs):	2
Type:		Full Truck	Rr Axle Load (lbs)	4
Description:		(3) Tandems	G.C.W. (lbs):	6
	Application		Road Conditions:	
Intended Serv.:		Snowplow	Class A (Highway)	
Commodity:		Other Commodity	Class B (Hwy/Mtn)	
	Body		Class C (Off-Hwy)	
Type:		End Dump	Class D (Off-Road)	
Length (ft):		13	Maximum Grade:	
Height (ft):		13.5	Wheelbase (in):	
Max Laden Weight (lbs):		3500	Overhang (in):	
	Trailer		Fr Axle to BOC (in):	
No. of Trailer Axles:		0	Cab to Axle (in):	
Type:			Cab to EOF (in):	
Length (ft):		0	Overall Comb. Length (in):	
Height (ft):		0.0		
Kingpin Inset (in):		0		
Corner Radius (in):		0		
	Restrictions			
Length (ft):		40		
Width (in):		102		
Height (ft):		13.5		

Special Req.

United States Registry

Approved by: _____

Date: _____

Note: All sales are F.O.B. designated plant of manufacture.

PacLease can help control costs and eliminate the challenges of owning, operating and maintaining your truck fleet.

- Improve Operations - Preserve Capital for Growth - Stay Focused on Your Business

Contact PacLease for a quote today, or visit our website @ www.paclease.com.

**Unpublished options may require review/approval.
Dimensional and performance data for unpublished options may vary from that displayed in PROSPECTOR.**

Printed:	2/23/2016 2:26:15 PM	Complete	Model Number:	Moc
Effective Date:	Jan 1, 2016		Quote/DTPO/CO:	Q023
Prepared by:	ID: rmich		Version Number:	

PETERBILT

<p>JX Peterbilt - Bolingbrook P128 535 E South Frontage Rd</p> <p>Bolingbrook, Illinois United States 60440 Phone: (630) 972-2720 Fax: (630) 972-2721 Email:</p>	<p>Village of Downers Grove 801 Burlington Ave</p> <p>Downers Grove, Illinois United States 60515 Phone: Fax: Contact Email: Prepared for:</p>
--	--

Data	Code	Description	\$ List	Weight
Base Model				
0003481	O	Model 348	99,848	10,640
0091200	O	Other Commodity	0	0
0093150	O	Snowplow Truck which is configured for mounting a snowplow to the front. May also have dump or other body.	0	0
0095170	O	End Dump	0	0
0098170	O	United States Registry	0	0

Configuration

0200700	O	Not Applicable Secondary Manufacturer	0	0
---------	---	---	---	---

Frame & Equipment

0519180	O	11-5/8in Steel Rails to 444in 11.625 x 3.874 x .375 Dimension, 2,568,000 RBM; Yield Strength: 120,000 psi. Section Modulus: 21.4 cubic inches. Weight: 1.91 lbs/inch pair	1,242	492
---------	---	---	-------	-----

0612160	O	178in Wheelbase	0	0
---------	---	------------------------	---	---

0613090	S	Three-Piece Crossmembers	0	0
---------	---	---------------------------------	---	---

0620530	O	FEPTO Provision 27.8in Bumper Extension Includes Crankshaft Adapter Plate and Stationary Grille. Requires FEPTO Bumper.	1,075	86
---------	---	--	-------	----

0644090	S	EOF Square without Xmbr For use with body builder installed crossmember.	0	0
---------	---	--	---	---

0651090	S	Omit Rear Mudflaps and Hangers	0	0
---------	---	---------------------------------------	---	---

Front Axle & Equipment

1011360	O	Dana Spicer D2000F 20,000 lb, 3.5in Drop Factory front axle alignment to improve handling & reduce tire wear. Zerk fittings on tie rod ends, king pins, & draglink ball joints for ease of maintenance & help extend service life of components. Cognis EMGARD® FE 75W-90 synthetic axle lube provides over 1% fuel economy improvement. Reduces wear & extends maintenance intervals,	1,566	445
---------	---	--	-------	-----

resulting in increased uptime. Provides improved fluid flow to protect components in extreme cold conditions & withstand the stress from high temperatures, extending component life.

1114030	O	Taper Leaf Springs, Shocks 20,000 lb Standard with Heavy Resistance Shocks.	1,312	0
1243050	O	Power Steering Sheppard HD94 Dual For use with 16,000 to 20,000 lb. axle ratings.	816	0
1250250	O	Power Steering Reservoir Frame Mounted w/Cooler	154	2
1354795	O	PHP10 Iron LMS Hubs-Air Disc	787	184
1380290	O	Air Disc Front Brakes Complies with reduced stopping distance regulations.	51	0
1390540	O	Dust Shields, CAM And Air Disc Brakes, Front Axle	26	4
1391410	O	Gusseted Cam Brackets, Steer Axle	24	0
Rear Axle & Equipment				
1526150	O	Meritor MT40-14X 40,000 lb	7,758	1,930
1616220	O	PHP10 Aluminum LMS Hubs	75	-60

11-1/4" bolt circle. Includes a supplier extended coverage up to 3 years / 350,000 miles for bearings & seals.

1631310	S	Standard Stroke Parking Brakes Drive Axle(s)	0	0
1660000	O	Dust Shields For Cam Brakes, Drive Axle(s)	30	15
1672630	O	Diff Lock Both Axles (Air Rocker Switch occupies the space of one gauge)	2,102	60
1680490	O	Gusseted Cam Brackets, Drive Axle(s)	24	2
1680500	S	SBM Valve Full trucks require a spring brake modulation (SBM) system for emergency braking application. This system requires an SBM valve and a relay valve with spring brakes on the rear axles. The SBM valve allows the foot valve to operate the rear axle spring brakes if a failure exists in the rear air system.	0	0
1680950	S	Stability System Not Selected or Not Available	0	0
1682430	S	Anti-Lock Braking System (ABS) 4S4M ABS-6. Includes air braking system.	0	0
1684200	S	Synthetic Axle Lubricant All Axles Peterbilt heavy duty models include Fuel Efficient Cognis EMGARD FE75W-90 which provides customers performance advantages over current synthetic lubricants with reduced gear wear and extended maintenance intervals, resulting in increased uptime. In addition, the lubricant provides improved fluid flow to protect gears in extreme cold conditions and withstand the stress from high temperatures, extending	0	0

component life.

1687010	S	Bendix Air Cam Rear Drum Brakes 16.5x7 Inc automatic slack adjusters & outboard mounted brake drums.	0	0
1687348	O	Tandem Drive Axle (Model 348)	0	0
1706430	O	Ratio 6.43 Rear Axle	0	0
1821800	O	Peterbilt Air Trac 40,000 lb, 52in Axle Spacing Light Weight	2,072	470
1922260	O	Dash Mtd Dump Switch With Indicator Light For suspension	32	2
Engine & Equipment				
2074404	O	PACCAR PX-9 330@2000 GOV@2200 1000@1400 (2013 Emissions) Includes alum flywheel housing, cruise control, and J1939 provisions (provides an interface point for the Electronic Service Analysis-ESA and other PACCAR approved diagnostic tools). Chevron Delo LE SAE 10W30 engine oil is specially formulated for new low emissions engines. Magnetic engine oil drain plug captures and holds any metal fragments in engine oil to extend service life. N21320 N205 120..Standard Maximum Speed Limit [LSL] N21330 N207 0....Expiration Distance N21340 P005 120..Hard Maximum Speed Limit N21350 P001 64...Maximum Accelerator Pedal Vehicle Speed N21360 P110 0....Accelerator Lower Droop N21370 P059 64...Maximum Cruise Speed N21380 P111 0....Cruise Control Lower Droop N21400 N203 252..Reserve Speed Function Reset Distance N21410 N202 0....Maximum Cycle Distance N21420 N206 10...Maximum Active Distance N21430 N201 0....Reserve Speed Limit Offset N21440 P015 No...Engine Protection Shutdown	2,867	0

N21450 P026 No...Gear Down Protection
 N21460 P046 1400.Max PTO Speed
 N21470 P062 No...Cruise Control Auto Resume
 N21480 P068 No...Auto Engine Brake in Cruise
 N21500 N209 0....Expiration Distance
 N21510 P520 Yes..Enable Idle Shutdown Park Brake Set
 N21520 P030 5....Timer Setting
 N21530 P233 Yes..Enable Impending Shutdown Warning
 N21540 P234 60...Timer For Impending Shutdown Warning
 N21550 P516 35...Engine Load Threshold
 N21570 P031 No...Idle Shutdown Manual Override
 N21590 P230 Yes..Enable Hot Ambient Automatic Override
 N21610 P172 40...Low Ambient Temperature Threshold
 N21620 P173 60...Intermediate Ambient Temperature Threshold
 N21630 P171 80...High Ambient Temperature Threshold

2091310	O	Engine Idle Shutdown Timer Disabled	0	0
2091315	O	Enable EIST Ambient Temp Override	0	0
2091372	O	Eff EIST NA Expiration Miles	0	0
2091640	O	Effective VSL Setting NA	0	0
2140010	O	Belly Pan	192	35
2140200	O	CARB Engine Idling Compliance PACCAR PX-7, PX-9 and MX, Cummins ISL, ISM and ISX diesel engines will include the required factory installed serialized sticker on the drivers door to identify them as meeting the NOx idling standard.	0	0

2513060	S	PACCAR 160 Amp Alternator, Brushed	0	0
2521090	O	Immersion Type Block Heater 110-120V Standard location is center left hand under cab and includes a weather-proof cover that protects the receptacle. This pre-heater keeps the coolant in the engine block from freezing when the engine is not running.	81	2
2522050	S	PACCAR 12V Starter	0	0
2538040	O	3 PACCAR Premium 12V Dual Purpose Batt 2100 CCA Threaded stud type terminal. Stranded copper battery cables are double aught (00) or larger to reduce resistance.	228	62
2621000	O	2-Speed Fan Clutch For Frequent Start/Stops	343	0
2723210	S	18.7 CFM Air Compressor Furnished on engine. Teflon lined stainless steel braided compressor discharge line.	0	0
2922780	O	Spin-On Fuel Filter/Water Separator, 12V Heated Frame Mounted. In addition to the fuel filter supplied with the engine. Includes fuel water separator on Models 330, 337, and 348.	78	0
3010400	O	Engine Protection Shutdown Includes oil pressure, oil temperature, coolant temperature, and intake manifold temperature.	4	0
3114270	S	High Efficiency Cooling System Cooling module is a combination of steel and aluminum components, with aluminum connections to maximize performance and cooling capability. Silicone radiator & heater hoses enhance value, durability, & reliability.	0	0

Constant tension band clamps reduce leaks. ClimaTech extended life coolant extends maintenance intervals which reduces maintenance costs. Anti-freeze effective to -30 degrees F helps protect the engine. Low coolant level sensor warns of low coolant condition to prevent engine damage. Radiator Size by Model: 587: 1330 sq in, 579/367 FEPTO 1325 sq in, 567/365/367: 1440 sq in, 384/386: 1301 sq in, 365 FEPTO: 1184 sq in, 389/367 HH: 1669 sq in, 348: 1000 sq in, 320: 1242 sq in.

3211120	S	Radial Seal, Dry Type Air Cleaner, Frontal Air Intake. Molded rubber air intake connections with lined stainless steel clamps seal to prevent contaminants in air intake.	0	0
3365040	S	Exhaust Single RH Side Of Cab DPF/SCR RH under cab. Includes cab entry RH under cab and full round stainless steel exhaust guard.	0	0
3381770	O	Curved Tip Standpipe(s)	43	0
3387610	O	18in Ht, 5in Dia Chrome, Clear Coat Standpipe(s)	0	-2
Transmission & Equipment				
4052110	O	Allison 3000 RDS-P Transmission, Gen 5 Rugged Duty Series. Includes Rear Transmission Support, TranSynd Automatic Transmission Fluid, and Water Oil Heat Exchange. Also includes features that monitor the transmission fluid, filter and clutch condition. Will display percent life remaining for the transmission fluid, filter and clutches on the shift selector. This information may be displayed using the Mode and Up and Down buttons. A wrench icon will also be included to indicate when the transmission fluid, filter or clutches need servicing. (Suited for vehicles operating on/off highway and/or requiring PTO operation) Forward Ratios: 1st-3.49, 2nd-1.86, 3rd-1.41, 4th-1.00, 5th-0.75, 6th-0.65 / Reverse Ratios: DR-(5.03)	9,936	110
4210080	S	1710 HD Driveline, 1 Midship Bearing	0	0

4250720	O	Allison FuelSense Not Desired	0	0
4252170	O	Auto Neutral Activates With Parking Brake	16	0
4256640	O	Allison 6-Speed Configuration, Close Ratio Gears 3000 Series Transmissions	0	0
4256980	O	Seat Mounted Lever Shifter	1,109	0
Air & Trailer Equipment				
4510750	S	Bendix AD-IS Air Dryer with Heater An integrated system air dryer that incorporates the functions of the air dryer, purge reservoir (which increases the drying capacity), wet air tank, pressure relief valve, single check valves, and pressure protection valve for air susp and other air accessories. Includes easy-to-service spin-on dessicant cartridge.	0	0
4520420	O	Berg Pull Cord Drain Valve(s) - All Air Tanks	5	0
4540420	S	Nylon Chassis Hose	0	0
4543320	S	Steel Painted Air Tanks All air tanks are steel with painted finish except when Code 4543330 Polish Aluminum Air Tanks is also selected (then exposed air tanks outside the frame rails will be polished aluminum). Peterbilt will determine the optimal size and location of required air tanks. Narratives requesting a specific air tank size or location will not be accepted for factory installation. See ECAT to determine number or location of air tanks installed.	0	0

4543390	○	High Mount Air Tanks BOC/BOS Where Possible Subject to frame review.	0	0
4611730	○	7-Way Electric Harness with Socket Mounted EOF	82	11
4611930	○	Body Connections 5ft BOC Junction Box contains light and power circuits for Body Connections located 5ft from BOC.	132	4
Tires & Wheels				
5068590	○	FF: BR 20ply 315/80R22.5 M860A Diameter = 42.8 inches; SLR = 19.9 inches	628	92
5169310	○	RR: BR 16ply 11R22.5 M799 Diameter = 42.0 inches; SLR = 19.5 inches	1,760	72
5190008	○	Code-rear Tire Qty 08	0	0
5210550	○	FF: Accur Stl Armor 29039PK 22.5X9.00 PHP10-5 Hand Holes	302	68
5310600	○	RR: Accur Stl Armor 50291PK 22.5X8.25 Heavy Duty, Two Hand Holes	508	112
5390008	○	Code-rear Rim Qty 08	0	0
Fuel Tanks				
5554100	○	26in Aluminum 70 Gallon Fuel Tank LH U/C Includes steps for cab access. Paddle handle filler cap with threadless filler neck. Top draw fuel plumbing reduces chance of introducing air into the fuel system during low fuel level conditions due to the central placement of fuel pickup tube. Wire braid fuel lines increase durability & reduce potential for leaks.	215	11
5602070	○	Location LH U/C 70 Gallon	0	0
5652890	○	DEF Tank Mounted LH BOC Models 210, 220 and 320 mounted LH cab fender.	0	0
5652990	○	Standard DEF To Fuel Ratio 2:1 Or Greater	0	0

5655019	S	DEF Tank Small	0	0
<hr/>				
Battery Box & Bumper				
6010780	O	Aluminum Space Saver Battery Box RH BOC Battery Access From Side	169	-84
<hr/>				
6030150	O	Rubber Battery Pad In Bottom Of (1) Battery Box (Mat in box that holds batteries only)	12	2
<hr/>				
6040550	S	Aftertreatment RH U/C Alum Non-Slip Cab Entry Step. DPF/SCR for diesel engines, catalyst for natural gas engines. On Models 579 specifying chassis fairings, the box will be aerodynamic.	0	0
<hr/>				
6121060	O	Steel Bumper Swept Back Painted Black, FEPTO only With two tow pin holes and step plates on top of bumper.	398	90
<hr/>				
Cab & Equipment				
6510110	S	Alum Cab 108in BBC Metton Hood w/Bright Crown Includes view window RH door and convex mirror over RH door.	0	0
<hr/>				
6540120	O	Severe Service Cab Package #1 Includes Aluminum side skins, aluminum rear skin, steel windshield mask, steel firewall, and steel front floor sheet on all cabs, and additional reinforcement structure on the back wall of the day cab.	94	39
<hr/>				
6540160	O	Thermal Insulation Package in Cab Includes thick, closed-cell foam in floor, special mylar-faced foam in walls and roof structure.	19	2

6800360	O	Rubber Fender Lips 2 Inch Wide	94	8
6911700	S	Peterbilt UltraRide Driver Seat	0	0
6921700	S	Peterbilt UltraRide Passenger Seat	0	0
6930590	O	Passenger Armrest - LH only Required with Evolution LX seats, optional with Evolution ST Seats.	35	2
6930800	O	Black Seat Color ipo Standard Color	0	0
6939400	S	Air Ride Driver	0	0
6939420	S	High Back Driver	0	0
6939470	S	Vinyl Driver	0	0
6939510	S	Non-Air Ride Passenger	0	0
6939520	S	High Back Passenger	0	0

6939570	S	Vinyl Passenger	0	0
7001520	O	Adjustable Steering Column - Tilt/Telescope	113	11
7001620	S	Steering Wheel with Peterbilt Logo Steering Wheel with embossed Peterbilt logo over horn button.	0	0
7036120	S	Interior Grey/Black Includes rugged charcoal instrument panels, glare-resistant gray dash, black bezels on gauges, (2) power ports, monochromatic molded door pads with durable in-mold color, gray molded back wall, 18 inch 4-spoke soft-touch steering wheel, soft-touch steering column cover, power lift passenger window, extruded rubber floor covering, header-mounted dome light, foot well lighting, integrated "dead pedal", (4) inside entry grab handles, (2) inside sunvisors, (2) coat hooks, (2) cup holders and map bin in dash.	0	0
7210430	O	Extended Rear Window ipo Std Window-Day Cab The extended rear window protrudes two inches more than the standard conventional rear cab window. Take this into consideration when determining your loadspace.	68	0
7210540	S	Day Cab Rear Window	0	0
7230060	S	One Piece Curved Windshield	0	0
7322010	S	Combo Fresh Air Heater/Air Conditioner With radiator mounted condenser, dedicated side window defrosters, Bi-Level Heater/Defroster Controls, 54,500 BTU/HR, and silicone heater	0	0

hoses.

7322130	O	Cup Holder (Floor Mounted) Includes two standard-size drink holders and one extra-large jugholder, coin tray, and clipboard-size storage area.	76	4
7410040	O	Outside Sunvisor - Stainless Steel Not available with 2.1M high roof sleeper.	132	4
7561180	O	Aero Mirrors Ea Side Htd & Mtrzd 4-Way Adjustable Bright Finish with Convex	520	4
7564110	O	Power Package Includes power door locks and power windows.	289	0
7610020	O	(1) Air Horn 15in Painted Mounted under cab.	161	8
7725710	O	Standard Speaker Package For Cab (2) Speakers	115	4
7725725	O	ConcertClass w/CD, Bluetooth Phone and Audio Includes AM/FM, WB, USB and MP3.	413	10
7748140	O	CB Terminals/Wiring Mtd Under Header	32	0
7788140	O	Radio Antenna Mounted on LH Mirror Bracket	32	0

7850210	O	Plug-In Auto Reset Circuit Breaker in place of fuses in junction box.	39	0
7851480	S	Peterbilt Electric Windshield Wipers With Intermittent Feature.	0	0
7851780	O	CabMate Cab Air Suspension Mfg by Link. The class 8 conventionals (except Model 348) includes (2) airbags, (2) shock absorbers, (1) leveling valve, radius rod, and height limiter. The Models 330, 337, and 348 includes (1) airbag and (1) shock absorber.	766	15
7900270	O	5 lb 3A:40bc Fire Extinguisher Cab Mounted	85	8
7901130	O	Backup Alarm (107dB)	56	3
8021380	S	Air Restriction Indicator Mounted on air cleaner or intake piping.	0	0
8071340	O	Bright Bezel Gauges	99	0
8071870	S	Main Instrumentation Panel, Graphics Display Includes speedometer with tripodometer, tachometer with hourmeter and outside air temperature display, voltmeter, engine oil pressure, engine coolant temperature, fuel level, primary and secondary air pressure gauges. Includes standard warning light package: high water temperature, low oil pressure, and low air pressure warning lights w/audible alarms, high beam, turn signal, low fuel, parking brake, and ice warning indicators; seat belt reminder; rocker switches with long-life LED indicators; multi-function turn stalk with flash-to-pass feature (night mode flashes headlights and marker lights; day mode flashes headlights only), intermittent windshield wiper and headlamp beam control. Hydraulic braked trucks do not include air pressure gauges.	0	0

8111110	S	Headlights Composite Fender Mounted Integral Park, Turn, and Side Marker	0	0
8120980	S	(5) Marker Lights, Aero LED Light Emitting Diodes	0	0
Paint				
8500710	O	Standard Paint Color Selection	-200	0
8530770	O	(1) Color Axalta Two Stage - Cab/Hood Base Coat/Clear Coat N85020 A - L0006EY WHITE - Stand N85400 HOOD TOP L0006EY WHITE - Stand N85500 CAB ROOF L0006EY WHITE - Stand N85200 FRAME N0001EA BLACK N85700 BUMPER N0001EA BLACK N85300 FENDER L0006EY WHITE - Stand	161	0
Options Not Subject To Discount				
9408905	O	Medium Duty Emissions Surcharge	0	0
Miscellaneous				
9409960	O	Presentation Created Using Featured Spec For Model	0	0
Total Adjusted Price (W/O Freight & Warranty & Surcharges)			\$141,301	
Freight Charge			\$2,100	
Options Not Subject to Discount			\$0	
Surcharges Not subject to Discount			\$0	
Total Weight			14979	

Prices and Specifications Subject to Change Without Notice.

Unpublished options may require review/approval.**Dimensional and performance data for unpublished options may vary from that displayed in PROSPECTOR.**

Printed:	2/23/2016 2:26:15 PM	Complete	Model Number:	Model 348
Effective Date:	Jan 1, 2016		Quote/DTPO/CO:	Q02312546
Prepared by:	ID: rmich		Version Number:	32.11