

VILLAGE OF DOWNERS GROVE
Report for the Village Council Meeting
5/16/2017

SUBJECT:	SUBMITTED BY:
7221 Lemont Road - Special Use for Animal Boarding	Stan Popovich, AICP Director of Community Development

SYNOPSIS

The petitioner is requesting Special Use approval to operate an animal boarding business at 7221 Lemont Road.

STRATEGIC PLAN ALIGNMENT

The goals for 2015-2017 include *Strong and Diverse Local Economy*.

FISCAL IMPACT

N/A

UPDATE & RECOMMENDATION

This item was discussed at the May 2, 2017 Village Council meeting. At the meeting, Council requested information on NTB noise complaints. The Village has no record of noise complaints from either NTB or Merlin Muffler at Lemont and Old Main. Additionally, Section 2 of the ordinance has been amended to include conditions #4, 5 and 6:

- Condition #4 limits the amount of dogs in the outdoor play area to no more than 35 at one time
- Condition #5 states the petitioner may be required to submit a report describing their compliance with the Village's noise restrictions
- Condition #6 states the hours of operation for the outdoor play area shall be limited to 8:00am to 6:00pm daily, and must be supervised by a trained employee at all times when in use

In response to concerns about noise expressed by residents near 7221 Lemont Road, the petitioner has redesigned the outdoor play area. The redesign includes the following:

- The fence enclosing the play area has been increased in height from 6' to 8' (see sheet A4.3)
- The sound baffles have been redesigned such that:
 - There is a double row of baffles overlapping each other (see sheet A4.2)
 - The baffles would extend vertically from the roof to a point 6" below the top of the fence (see sheet A4.1)

Staff recommends approval at the May 16, 2017 Village Council meeting.

BACKGROUND

The petitioner is requesting Special Use approval to allow an animal boarding business at 7221 Lemont Road. The business will occupy the northern end unit, formerly a Walgreens, of the Downers Park Plaza shopping center. The applicant is proposing a full-service training, grooming and boarding facility for dogs with 88 boarding units, an indoor/outdoor pet play area and an office. The animal boarding service is a Special Use per Section 5.010 of the Zoning Ordinance.

The business is proposed to be open seven days of the week and shall be staffed 24 hours a day with on-site personnel. The outdoor play area will be situated along the east side of the building and enclosed by a six foot solid fence with sound baffling above the fence running to the roof structure. The outdoor play area will be supervised by trained staff at all times. Typical hours of operation for the outdoor pet play area is between 8:00 am – 4:00 pm. The outdoor pet play area will not be used after 6:00 pm. There are no exterior building or parking lot changes proposed on the property other than relocating the entrance from the west façade to the north façade to have a greater separation of distance from the adjacent tenant space.

Compliance with the Comprehensive Plan

The current Comprehensive Plan's (Plan) Future Land Use Map designates this property as Corridor Commercial. These commercial areas have a "unique character" and should provide "the daily needs of local residents" and "services to the larger region".

The Village is currently in the process of updating the Comprehensive Plan and included the examination of the 75th Street corridor within the scope of the project. The 75th Street Focus Area Plan notes that the Downers Park Plaza should remain commercial and the property should be screened from the residential uses on the east side and that dumpster enclosures should be strictly enforced on the site.

The proposed development achieves all of the aforementioned goals as the proposed use will serve the needs of the neighboring community and the larger region. The petitioner has proposed screening of the outdoor pet play area with a six foot solid fence. A new dumpster enclosure is also proposed at the rear of the property, per the Comprehensive Plan recommendations. The proposed project is consistent with both the current and the draft updated Comprehensive Plan.

Compliance with the Zoning Ordinance

The property is zoned B-2/PUD, General Retail Business/Planned Unit Development. A pet grooming service is a permitted use in the B-2 zoning district, and the animal boarding facility is an allowable Special Use per Section 5.010 of the Zoning Ordinance. The petitioner is not proposing to make any significant changes to the building or the parking lot. The property will continue to meet all requirements of the Zoning Ordinance.

Public Comment

Fifteen members of the public spoke at the Plan Commission. Fourteen in opposition and one in support of the petition. The petitioner and staff addressed the public concerns in their presentation at the Plan Commission meeting. The concerns and responses are presented below:

Concern	Response
Noise	<ul style="list-style-type: none"> The proposed facility is 220 feet from the nearest residentially zoned property. Sound baffles will be installed around the outdoor play area and also between the six foot solid fence and the roof

	<ul style="list-style-type: none"> • Dogs will not be allowed outside after 6:00 PM.
Cross contamination with adjacent tenants spaces	<ul style="list-style-type: none"> • All liquid animal waste will be disposed into the sanitary sewer • The entry door will move from the west facade to the north façade of the building to increase the separation from the adjacent grocery store entrance door. • HVAC systems will comply with building codes
Odor	<ul style="list-style-type: none"> • A waste management company will be contracted to pick-up trash once every two days and staff will keep the parking lot area clean of litter and waste on a daily basis.
Traffic	<ul style="list-style-type: none"> • The animal boarding facility is estimated to generate less traffic than the former retail store.

ATTACHMENTS

Ordinance

Aerial Map

Staff Report with attachments dated April 3, 2017

Draft Minutes of the Plan Commission Hearing dated April 3, 2017

Neighbor correspondence

A4.1

A4.2

A4.3

Diminished Noise Levels document

VILLAGE OF DOWNERS GROVE
COUNCIL ACTION SUMMARY

INITIATED: Applicant DATE: May 16, 2017
(Name)

RECOMMENDATION FROM: _____ FILE REF: 17-PLC-0005
(Board or Department)

NATURE OF ACTION:

STEPS NEEDED TO IMPLEMENT ACTION:

- Ordinance
- Resolution
- Motion
- Other

Motion to Adopt "AN ORDINANCE
AUTHORIZING A SPECIAL USE FOR 7221
LEMONT ROAD TO PERMIT AN ANIMAL
BOARDING FACILITY as presented.



SUMMARY OF ITEM:

Adoption of the attached ordinance will authorize a special use for 7221 Lemont Road to permit an animal boarding facility.

RECORD OF ACTION TAKEN:

ORDINANCE NO. _____**AN ORDINANCE AUTHORIZING A SPECIAL USE FOR 7221 LEMONT ROAD
TO PERMIT AN ANIMAL BOARDING FACILITY**

WHEREAS, the following described property, to wit:

LOT 2 IN DOWNERS PARK, BEING A RESUBDIVISION OF PINE HILLS UNIT NUMBERS 1 AND 2, BOTH BEING SUBDIVISIONS IN THE NORTHWEST ¼ OF SECTION 29, TOWNSHIP 38 NORTH, RANGE 11, EAST OF THE THIRD PRINCIPAL MERIDIAN, ACCORDING TO THE PLAT THEREOF RECORDED SEPTEMBER 14, 1979 AS DOCUMENT R79-83345, IN DUPAGE COUNTY, ILLINOIS.

Commonly known as: 7221 Lemont Road, Downers Grove, IL 60516
PINs: 09-29-110-007

(hereinafter referred to as the "Property") is presently zoned in the "*B-2/PUD, General Retail Business/Planned Unit Development District*" under the Comprehensive Zoning Ordinance of the Village of Downers Grove; and

WHEREAS, the owner of the Property has filed with the Plan Commission, a written petition conforming to the requirements of the Zoning Ordinance, requesting that a Special Use per Section 28.12.050 of the Zoning Ordinance be granted to permit an animal boarding facility; and,

WHEREAS, such petition was referred to the Plan Commission of the Village of Downers Grove, and said Plan Commission has given the required public notice, has conducted a public hearing for the petition on April 3, 2017 and has made its findings and recommendations, all in accordance with the statutes of the State of Illinois and the ordinances of the Village of Downers Grove; and,

WHEREAS, the Plan Commission has recommended approval of the Special Use, subject to certain conditions; and,

WHEREAS, the Village Council finds that the evidence presented in support of said petition, as stated in the aforesaid findings and recommendations of the Plan Commission, is such as to establish the following:

1. That the proposed use is expressly authorized as a Special Use in the district in which it is to be located.
2. That the proposed use at the proposed location is necessary or desirable to provide a service or a facility that is in the interest of public convenience and will contribute to the general welfare of the neighborhood or community.
3. That the proposed use will not, in the particular case, be detrimental to the health, safety or general welfare of persons residing or working in the vicinity or be injurious to property values or improvements in the vicinity.

NOW, THEREFORE, BE IT ORDAINED by the Council of the Village of Downers Grove, in DuPage County, Illinois, as follows:

SECTION 1. That Special Use of the Property is hereby granted to allow construction of an animal boarding facility.

SECTION 2. This approval is subject to the following conditions:

1. The Special Use shall substantially conform to the staff report dated April 3, 2017; architectural drawings prepared by Studio21architects dated March 3, 2017, as amended May 11, 2017, except as such plans may be modified to conform to the Village codes and ordinances.
2. The applicant shall apply for all signage under a separate permit and shall comply with the Sign Ordinance.
3. The building shall be equipped with an automatic fire suppression system and an automatic and manual fire alarm system.
4. At no time shall more than ninety-four (94) dogs be allowed at the facility.
5. At no time shall more than thirty-five (35) dogs be within the outdoor play area.
6. At the discretion of the Village Manager, Petitioner may be required to submit a report detailing compliance with Section 28.10.040.B of the Downers Grove Zoning Ordinance (Operational Performance Standards - Noise), including but not limited to the duration and decibel levels of the noise emitted from the property. Any violation of this section or of the Downers Grove Zoning Ordinance shall be deemed grounds for revocation of the Special Use granted herein and shall be subject to the remedies and enforcement powers afforded the Village in Section 28.13.020.D of the Downers Grove Zoning Ordinance.
7. The hours of operation for the outdoor play area shall be limited to 8:00am to 6:00pm daily, and shall be supervised by a trained employee at all times when in use.

SECTION 3. The above conditions are hereby made part of the terms under which the Special Use is granted. Violation of any or all of such conditions shall be deemed a violation of the Village of Downers Grove Zoning Ordinance, the penalty for which may include, but is not limited to, a fine and/or revocation of the Special Use granted herein.

SECTION 4. It is the Petitioner's obligation to maintain compliance with all applicable Federal, State, County and Village laws, ordinances, regulations, and policies.

SECTION 5. That all ordinances or parts of ordinances in conflict with the provisions of this ordinance are hereby repealed.

Mayor

Passed:

Published:

Attest: _____

Village Clerk



**VILLAGE OF DOWNERS GROVE
REPORT FOR THE PLAN COMMISSION
APRIL 3, 2017 AGENDA**

SUBJECT:	TYPE:	SUBMITTED BY:
17-PLC-0005 Animal Boarding Facility at 7221 Lemont Road	Special Use	Swati Pandey Planner

REQUEST

The petitioner is requesting Special Use approval to operate an animal boarding business at 7221 Lemont Road which is located in the B-2/PUD, General Retail Business/Planned Unit Development zoning district.

NOTICE

The application has been filed in conformance with applicable procedural and public notice requirements.

GENERAL INFORMATION

OWNER:	Kimco Realty 10600 W. Higgins Road, Ste. 408 Rosemont, IL 60018
APPLICANT:	Pete & Mac's Pet Resort 1255 W. Baseline Road, Ste. D112 Mesa, AZ 85202

PROPERTY INFORMATION

EXISTING ZONING:	B-2/PUD, General Retail Business/Planned Unit Development
EXISTING LAND USE:	Vacant retail store
PROPERTY SIZE:	915,908 sq ft (21 acres)
PIN:	09-29-110-007

SURROUNDING ZONING AND LAND USES

	ZONING	FUTURE LAND USE
NORTH:	R-5A, Residential Attached House 5A	Single Family Residential & Single Family Attached Res.
SOUTH:	B-2, General Retail Business	Corridor Commercial
EAST:	R-1, Residential Detached House 1 R-3, Residential Detached House 3	Single Family Residential Single Family Residential
WEST:	B-2, General Retail Business R-5A, Residential Attached House 5A	Corridor Commercial Single Family Residential Parks & Open space

ANALYSIS

SUBMITTALS

This report is based on the following documents, which are on file with the Department of Community Development:

1. Project Narrative
2. Plat of Survey
3. Site Plan
4. Floor Plan
5. Elevations
6. Photographs

PROJECT DESCRIPTION

The petitioner is seeking Special Use approval to operate an animal boarding business at 7221 Lemont Road located southwest of the intersection of Lemont Road and Main Street. The business will occupy the northern end unit of the 'Downers Park Plaza' shopping center, formerly occupied by Walgreens. The applicant is proposing a full-service training, grooming and boarding service facility for dogs. The animal boarding service is a Special Use per Section 5.010 of the Zoning Ordinance. As such, the petitioner is required to apply for a Special Use to operate an animal boarding facility at the subject property. Currently, the subject property is zoned B-2/PUD, General Retail Business/Planned Unit Development and is improved with a one-story multi-unit commercial building and surface parking lot.

The applicant's proposal includes the following features:

- Reception/Lobby/Waiting Area
- Pet boarding rooms – 88 units
- Pet grooming area
- Indoor play area
- Outdoor play area
- Employee office
- Kitchen/Pantry

The business is proposed to be open all seven days of the week and shall be staffed 24/7 with on-site personnel. The outdoor play area will be situated along the east side of the building and enclosed by a six foot solid fence. Any noise created from the outside play area will be minimized by the noise baffles proposed by the petitioner that helps reduce the noise. There will be a maximum of 35 pets at any time in this area which will be supervised by trained staff. The outdoor pet play area will not be used after 6:00 pm. There will be a new outdoor trash enclosure on the east side of the building, in compliance with the requirements. There are no exterior building or parking lot changes proposed on the property. The signage for the business shall be in compliance with the Zoning Ordinance.

COMPLIANCE WITH THE COMPREHENSIVE PLAN

The current Comprehensive Plan's (Plan) Future Land Use Map designates this property as *Corridor Commercial*. *Corridor Commercial* uses include - a blend of neighborhood oriented commercial retail, offices and service uses that provide services and retail opportunities to the nearby neighborhoods and the surrounding region. The current Plan specifically mentions that the 75th Street corridor continue to contain a range of these types of uses. These commercial areas have a "unique character" and should provide "the daily needs of local residents" and "services to the larger region".

17-PLC-0005; 7221 Lemont Road
April 3, 2017

Page 3

The Village is currently in the process of updating the Comprehensive Plan and included the examination of the 75th Street corridor within the scope of the project. The 75th Street Focus Area Plan notes the Downers Park Plaza property should be screened from the residential uses on the east side and dumpster enclosures should be strictly enforced on the site.

The proposed development achieves all of the aforementioned goals as the proposed use will be serving the needs of the neighboring community and the larger region with animal services. The petitioner has proposed screening of the outdoor pet play area with a six foot solid fence. A new dumpster enclosure is also proposed at the rear of the property, per the Comprehensive Plan recommendations.

The proposed project is consistent with both the current and the draft Comprehensive Plan.

COMPLIANCE WITH ZONING ORDINANCE

The property is zoned B-2/PUD, General Retail Business/Planned Unit Development. A pet grooming service is a permitted use in the B-2 zoning district where an animal boarding facility is an allowable Special Use per Section 5.010 of the Zoning Ordinance. The petitioner is not proposing to make any changes to the building or the parking lot. The new outdoor pet play area will be located 77 feet from the east property line, in the interior side yard, which is abutting a B-2 zoning district. The commercial property to the east, immediately to the rear of the shopping center will serve as an additional buffer between the new proposed use and the single-family residential properties across Main Street. There are no setback requirements for interior side yard in the Business district, unless it is abutting a residential district. The new business would be located approximately 420 feet from the nearest single family property to the east and approximately 220 feet from the nearest multi-family property to the north. The new trash enclosure will comply with the zoning requirements. The northwest corner of the building is approximately 115 feet from the property line along Lemont Road.

The property will continue to meet all requirements of the Zoning Ordinance.

PARKING AND TRAFFIC

The proposed use will not have a negative impact on the existing parking and traffic patterns in the area. A parking analysis of the north building of the Downers Park Plaza shopping center shows that 498 parking spaces are required. There are 720 parking spaces provided on the north parcel (excluding the south parcel and all outlots). Also, the property owner stated that the entire Downers Park Plaza is allocated parking at 5.5 spaces per 1,000 square feet, which is higher than the parking ratio required by the current and proposed use on the property.

Therefore, the proposed use and the overall shopping center will meet the parking requirements.

NEIGHBORHOOD COMMENT

Notice was provided to all property owners 250 feet or less from the property in addition to posting public hearing notice signs and publishing the legal notice in the *Downers Grove Suburban Life*. There have been no public comments received by staff.

FINDINGS OF FACT

The petitioner is requesting a Special Use to operate an animal boarding facility. Staff finds that the proposal meets the standards for granting a Special Use as outlined below:

Section 28.12.050.H Approval Criteria

No special use may be recommended for approval or approved unless the respective review or decision-making body determines that the proposed special use is constituent with and in substantial compliance with all Village

Council policies and plans and that the applicant has presented evidence to support each of the following conclusions:

1. *That the proposed use is expressly authorized as a Special Use in the district in which it is to be located;* The property is located in the B-2/PUD, General Retail Business/Planned Unit Development zoning district. Under Section 5.010 of the Zoning Ordinance, an animal boarding facility is listed as an allowable Special Use in the B-2 zoning district. This standard has been met.

2. *That the proposed use at the proposed location is necessary or desirable to provide a service or a facility that is in the interest of public convenience and will contribute to the general welfare of the neighborhood or community.*

The proposed new animal boarding facility is desirable on the 75th Street Corridor and will contribute to the general welfare of the community. The proposed development will meet various Comprehensive Plan goals including the screening on the east side and dumpster enclosure on the property. The new use at this location would serve the needs of the local and regional population as is intended for this Corridor Commercial property. This standard has been met.

3. *That the proposed use will not, in the particular case, be detrimental to the health, safety or general welfare of persons residing or working in the vicinity or be injurious to property values or improvements in the vicinity.*

The proposed development will not be detrimental to the health, safety or general welfare of persons residing in or working in the vicinity and will not be injurious to property values or improvements in the vicinity. The proposed development will take a large vacant tenant space in the shopping center and utilize it with a full-service animal boarding business. Property values will not be negatively impacted as a service use will be added to the vacant tenant space which will help the shopping center with new business attraction. The petitioner has proposed several design elements into the project to minimize any potential impacts including the screening material and location of an outdoor play area located on the east side (rear) of the building. This standard has been met.

RECOMMENDATIONS

The proposed Special Use for an animal boarding business at 7221 Lemont Road is consistent with the current and draft Comprehensive Plan and the Zoning Ordinance. Based on the findings listed above, staff recommends the Plan Commission forward a positive recommendation to the Village Council regarding 17-PLC-0005 subject to the following conditions:

1. The Special Use shall substantially conform to the staff report; architectural drawings prepared by Studio21architects dated March 3, 2017, except as such plans may be modified to conform to the Village codes and ordinances.
2. The applicant shall apply for all signage under a separate permit and shall comply with the Sign Ordinance.
3. The building shall be equipped with an automatic suppression system and an automatic and manual fire alarm system.

17-PLC-0005; 7221 Lemont Road
April 3, 2017

Page 5

Staff Report Approved By:



Stanley J. Popovich, AICP
Community Development Director

SP; sp
-att

Pet Resorts, Inc

the parent company of Pete & Mac's Pet Resorts
1255 W Baseline Rd., #D-112
Mesa, AZ 85202
Phone: (480) 970-6166 • Fax: (480) 970-4496



pet lodging • daycare • grooming • training • boutique

January 30, 2017

To Whom It May Concern:

On behalf of Pete & Mac's Pet Resorts we are pleased to submit this Plan Commission Application.

Pete & Mac's Pet Resorts has been in the business of home away pet care since 1999. Pete & Mac's offers overnight boarding, daycare, grooming and training for dogs. Pete & Mac's opened its first pet resort in Lenexa, KS and through the years has opened subsequent Pete & Mac's in Lee's Summit, MO, Kansas City, MO, Gilbert, AZ and Avondale, AZ. Pete & Mac's has served tens of thousands of family pets through the various locations.

Pete & Mac's Pet Resorts wishes to open a location in the Village of Downers Grove located at 7221 Lemont Road. The location is an empty Walgreen's measuring approximately 12,000 square feet. Pete & Mac's plans are to provide, at the facility, overnight boarding, daily daycare services, grooming and training. Pete & Mac's is unique in that the sleeping quarters for the guests are constructed out of light enhancing glass tiles rather than chain link or prefab particle board rooms. Daycare is provided in two separate fully climate controlled areas according to size and temperament. The resort is open seven days a week with hours conducive to better serve the clients of the community. Pete & Mac's prides itself in never leaving the resort alone or remotely monitored. A working night shift is present after closing hours therefore providing 24/7 care for the guests. Hours of operation are Monday – Friday 6:30am-7pm, Saturday 8am-5pm and Sunday 8am-6pm.

Pete & Mac's Pet Resorts seeks village approval of a Special Use Permit (Municipal Code 28.12.050H) per the drawings submitted by Studio21 Architects on our behalf and the attached Exhibit A, Special Use Factors. Pete & Mac's Pet Resorts approval request is reasonable, justified and consistent with the goals in the village's Comprehensive Plan.

Revised 2/28/17 from initial submittal: General

Use and Operation of the outdoor play area. There will only be one outdoor play area designed for the larger breed guests. The maximum number in the play area at one time will not exceed 35 and will be under the constant supervision of a Level 3 Pet Guardian. The Level 3 Pet Guardian has completed Level 1 and 2 company training with sufficient hours shadowing under a current Level 3 in order to have status of a Daycare Pet Guardian.

Daycare hours are from 8am to 4pm. All daycare dogs receive an hour break at 11am at which time they are brought back into the resort and put in individual rooms where they are allowed to rest and receive a treat or lunch (if the owners request). Play then continues from 12pm-4pm. Guests are then brought back into the resort and put back into individual rooms to await pick up by their parents. The latest this area would be used is 6pm. If we have overnight guests who cannot participate in the daycare group play (non neutered/spay or not a good candidate for group play) these guests are taken out for individual play time with a Pet Guardian which is concluded before 6pm.

As mentioned previously the daycare area is constantly supervised by highly trained staff that are cognizant of the noise level and have methods to keep the dogs active without causing any excessive barking. The area will be constructed with noise baffles (specification sheet attached) that will be placed between the fence and roof line to again abate any noise back to the building.

Site Design

The surface material for the outdoor play area is comprised of a perimeter nailer board attached to the concrete with tapcon screws or ramset nails, then a layer of a 1" rubber air grid and the final layer of the K9 Grass™. The K9 Grass has a unique knitted backing with flow-through technology and is treated with an antimicrobial to mitigate any odor. The outdoor area will have drainage that will connect to the trench drain system in the building. Roof material will be the polyvinyl chloride (PVC), the same as the fence material. (Specification sheets attached for the air grid and K9 Grass)

The material for the outdoor play area and roof of the play area will be the polyvinyl chloride (PVC). This type fencing is five times stronger than wood or chain link and features a steel reinforced bottom rail for a stronger, more rigid fence. The area between the top of the fence and the roof line will have sound baffles installed to minimize any noise to the outside. (Specification sheets attached for the polyvinyl fencing and noise baffles).

Pete & Mac's Pet Resorts has a long tradition of supporting its residents and businesses. Pete & Mac's has been a long supporter of local pet rescue offering free boarding for adoptable pets when available along with quarterly Yappy Hours held to benefit a specific rescue group. Pete & Mac's also makes an effort to get out into the community by offering an Employee Benefit Program geared toward offering discounts to local businesses employees. Pete & Mac's is active in the local veterinary community by way of referring clients for required vaccinations as Pete & Mac's offer no veterinary services.

Thank you for your consideration and please do not hesitate to contact myself with questions.
Sincerely,

Gay Barwald
President/Chief Operating Officer

EXHIBIT A
SPECIAL USE FACTORS

1) The proposed use is expressly authorized as a special use in the B-2 Zoning District.

Animal services facilities are allowed as a permitted use in the B-2 Zoning District. In addition to offering retail products, dog daycare, grooming services and training opportunities, Pete & Mac's Pet Resort will also provide overnight boarding. The proposed boarding service requires special use approval; all other components of Pete & Mac's Pet Resort's operations are permitted by right in the B-2 Zoning District.

2) The proposed use at the proposed location is necessary or desirable to provide a service or a facility that is in the interest of public convenience and will contribute to the general welfare of the neighborhood or community.

Pete & Mac's Pet Resort's proposed use meets an important and demonstrated community need for quality home away care for dogs. In the course of conducting demographic and marketing studies of the residents and those residing in surrounding communities the proposed services offered by Pete & Mac's will fill a need for the provided services to the over 24,000 pet owners within a 20 minute drive time of the proposed facility. The subject property is located at the intersection of 75th Street and Lemont which has over 35,000 and 27,000 cars per day respectively. The subject property would serve as an easy drop off and pick up for clients utilizing the services along with the convenient hours the business maintains. The subject property's strategic location and the need for the services will likely increase tax revenue for the community.

3) The proposed use will not be detrimental to the health, safety or general welfare of persons residing or working in the vicinity or be injurious to property values or improvements in the vicinity.

Pete & Mac's Pet Resort's proposed use will not adversely impact the surrounding properties, residents, or businesses. Pete & Mac's facility will be licensed by the Illinois Department of Agriculture and subject to regular inspection. Pete & Mac's facility will contain a special air handling system to cycle the air several times an hour to reduce the risk of any airborne virus and to maintain an odor free facility. The facility is also equipped with an automatic waste flush system that again reduces any odor causing contaminants and provides for a clean, healthy environment for the guests and any neighboring residents or businesses.

Pete & Mac's staff will be highly trained on all aspects of animal care and behavior. Staff will also receive certification on Pet CPR and First Aid. The business expects to hire and employ 25 staff members to include an overnight pet guardian so the facility and guests are never left alone.

The business is consistent with the use of the surrounding properties in that Pete & Mac's will provide valuable, daily services within close proximity to the village's residents. Nearly all of Pete & Mac's activities will be conducted indoors. Pete & Mac's outdoor exercise area will be fully screened by an eight foot tall fence along with noise buffer pads. All outdoor activity is concluded at the facility no later than 6pm nightly. Neighboring businesses have approved our usage and any residential is situated far enough from the facility as to not cause any issues.

Pete & Mac's Pet Resort
7221 Lemont Road - Downers Park Plaza - North Parcel
Parking Summary

Use Group	Square Footage	Parking requirement per 1000 sq ft	Total Parking required
Retail	49788	4.00	199
Restaurant	5500	3.50	19
Office - Medical	9020	4.50	41
Office - Business	3500	3.00	11
Grocery	46610	4.00	186
Animal Services (Pete & Mac's Pet Resort)	12000	3.50	42
Total parking required			498
Total parking provided in North Parcel			720
Total parking provided in Entire Downers Park Plaza - 5.5 parking spaces per 1,000 sq ft			1563

by ForeverLawn

[Product](#)
[Photo Gallery](#)
[Installation Process](#)
[Featured Projects](#)
[Safety](#)
[K9Grass Mats](#)

[K9Grass Profile](#)
[Contact Us](#)
[News](#)

K9GRASS PROFILE

K9Grass is a ForeverLawn brand. ForeverLawn is a leading supplier of synthetic turf that was created out of a desire to develop and provide the highest quality, most technologically advanced synthetic grass products for a variety of uses. For more information on ForeverLawn, visit www.foreverlawn.com.

For several years, we had installed our synthetic grasses for use with dogs in yards and kennels. While synthetic turf definitely offered advantages, there were very distinct drawbacks as well. There were limitations in drainability, cleanability, durability, etc as well as issues with excessive odor from urine absorbing into the infill material.

Finally, one day, we asked the question – “How could we improve a synthetic grass product for use with dogs?” The pursuit of this answer sent us on a 10-month journey – the end result being K9Grass.

We changed everything. We made it knitted, to create the unique flow-through backing. We added AlphaSan, an antimicrobial agent, to protect the yarn from stains and odors associated with bacteria. The knitted construction enabled us to achieve a density not possible through tufting (the common turf construction), which eliminates the need for infill. The durability and construction makes it completely washable.

In short, K9Grass is a truly unique product that is unmatched in the industry. It was developed to specifically meet and fill a need in the marketplace, and was developed with specific thought and intent. What it is not is a label slapped on a common turf product. Today, you can find any number of products claiming to be “for dogs”, but don’t be fooled by the label. Look to the construction of the product. Look to the integrity of the company behind it. Look to K9Grass.



K9Grass - The artificial grass designed specifically for dogs!



Grass Without Limits.

Visit www.foreverlawn.com

Copyright 2011 ForeverLawn. All Rights Reserved. [[Contact ForeverLawn](#)]

K9Grass®

by ForeverLawn™

[Product](#)
[Photo Gallery](#)
[Installation Process](#)
[Featured Projects](#)
[Safety](#)
[K9Grass Mats](#)
[K9Grass Profile](#)
[Contact Us](#)
[News](#)

PRODUCT

K9Grass® Classic



The original pet-friendly grass. Durable, drainable, and antimicrobial.

- **Yarn Type:** Primary: Polyethylene monofilament
Secondary: Heat set textured nylon monofilament
- **Yarn Color:** Primary: Summer Green
Secondary: Turf Green
- **Yarn Count:** Primary: 5,000/4
Secondary: 4,200/8
- **Construction:** Knitted
- **Blade Height:** 3/4"
- **Face Weight:** 72 ounces
- **Total Product Weight:** 87 ounces
- **Backing:** Flow-through backing
- **Antimicrobial Protection:** AlphaSan®
- **Seaming:** Turf adhesive
- **Infill:** NONE

Just ask some of our
satisfied clients:

- [LA Dogworks](#)
- [Ruffin'it Resort](#)
- [Armada Kennels](#)
- [Saratoga Creek Dog Park](#)
- [Limestone Ridge Kennels](#)
- [Red Dog Pet Resorts](#)
- [San Francisco Animal Care & Control](#)
- [Harmony Pet Resort](#)
- [Nestle Purina](#)
- [Cobble Hill Bed & Biscuit](#)
- [Morris Animal Inn](#)
- [Pete and Mac's Pet Resort](#)
- [Houston Dog Ranch](#)
- [Holiday Barn Pet Resorts](#)
- [Pets Unlimited](#)
- [Citizen Canine](#)
- [Arguello Pet Hospital](#)
- [Petropolis](#)

Grass Without Limits.

Visit www.foreverlawn.com

K9 Grass™

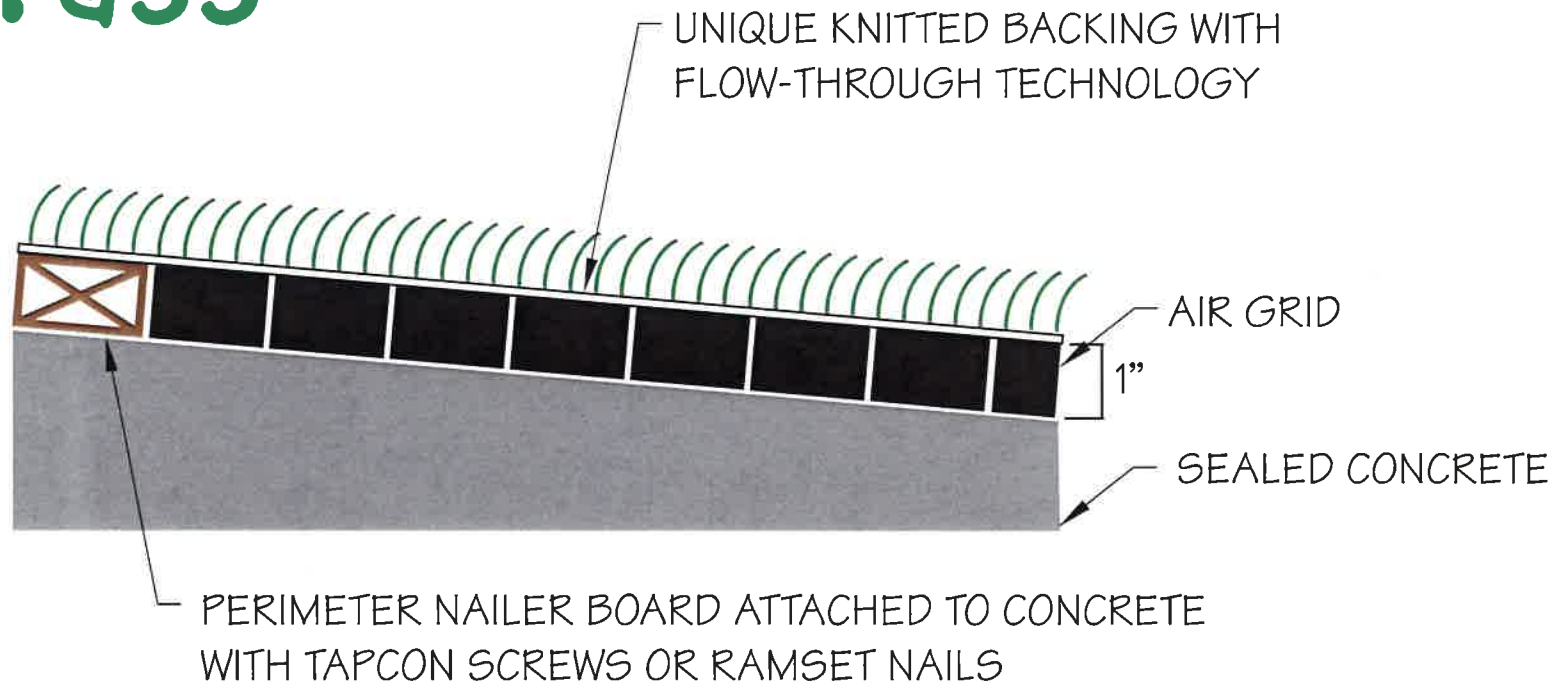

DETAIL #5: EDGING DETAIL ON CONCRETE BASE



ForeverLawn Inc. 4500 Bogan Avenue NE Albuquerque, NM 87109 Phone: 505.217.0177 Fax: 866.212.1925 www.K9grass.com www.foreverlawn.com	drawn by	name T. Smith	date 12/01/06
	reference:	quote #	ref dwg
	approved by:		
	scale:	Not to Scale	
	drawing no.	DETAIL 5	

AirDrain

– What drains better than Air?

For K9 Areas: Pet Playgrounds, Dog Runs, Kennels and More.....

Tried and true with over 200 K9 areas installed, [AirDrain K9 Drainage by AirField Systems](#) is the ideal synthetic drainage system used in dog day care facilities, pet playgrounds, airport dog potties and general use common areas, for dogs all across America.

Made with 100% post industrial recycle content AirField uses the highest quality materials for the AirDrain Geocell. With a 92% air void space underneath your artificial turf, you are able to wash away any unwanted waste left behind if needed by installing a flushing system underneath the grid. This system is easily installed and attaches to any water source with inexpensive pvc piping. Low cost, easy to install, do it yourself drainage, makes AirDrain the ideal synthetic drainage system for kennels, dog boarding and pet facilities, dog parks, vet clinics, and even in your own backyard.

K9 areas are installed every day in public and private facilities across the world. Whether you utilize natural or artificial turf, the AirField System is a stress-free way to turn any common space into a fun place for people and their K9 friends. No more worrying about expensive and destructive gravel drainage and no problems with waste being left behind. An AirField System is the easiest and fastest way to install a K9 recreation area.

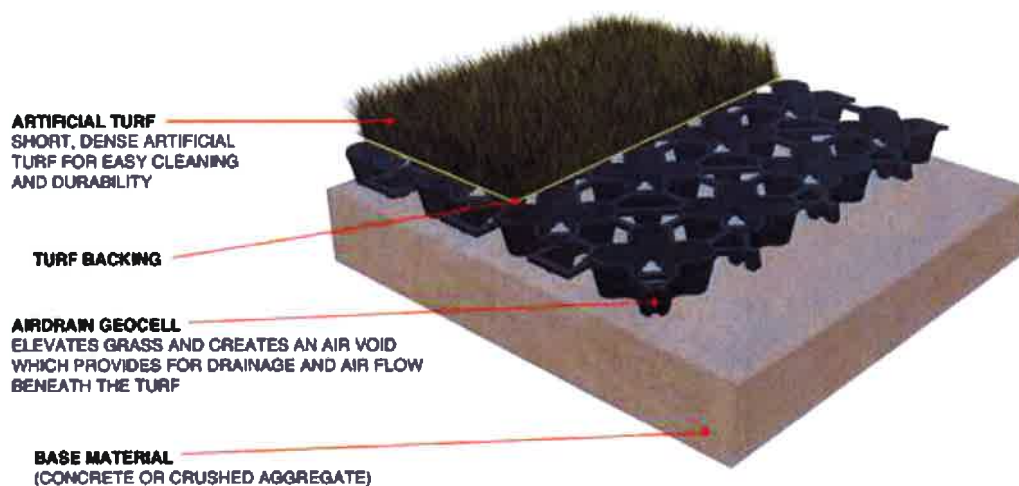

Benefits of an AirField drained K9 area include:

- 100% post industrial recycled content
- 92% air-void space for fast and easy waste removal
- Ability to flush the area daily
- AirDrain's quick snap connectors allows for effortless installation
- Minimal site disturbance, far less excavation and disposal
- Compact shipping reducing transportation costs
- Over 200 K9 areas installed around the world

DESIGNER PRIVACY FENCE

Features

- 48", 60", 72" Heights
- Aluminum Frames Can Be Purchased Separately
(Frames Include: Rail, Posts and Caps)
- 8' Sections Standard (4', 5', 6', 7' Sections Optional)
- Optional Vinyl or Acrylic ASA In-fills (Vertical Panels and Side Channels)
- 12 Standard Verified AAMA 2604 & 2605 Compliant Powder Coated Aluminum Component and Gate Frame Colors
- 7 Standard In-fill Colors
- Lifetime Limited Warranty
- Virtually Maintenance Free

* Buy the Complete System or Purchase Components*

Aluminum Components And Gate Frame Colors

Optional In-Fill Materials & Colors

	DSI 101 Satin Black	Westwood Mocha	
	DSI 102 Gloss White	Westwood Stone	
	DSI 104 Gloss Beige	Westwood Sierra	
	DSI 106 Black Fine Texture	Westwood Tan	
	DSI 107 Bronze Fine Texture	Westwood White	
	DSI 121 Speckled Walnut	Snap-Lock T&G Tan	
	DSI 122 Sandy Shore	Snap-Lock T&G White	
	DSI 123 White Fine Texture	<p>All colors shown are a close representation of the true color. Please consult actual samples for accurate powder coating colors.</p>	
	DSI 124 Chocolate		
	DSI 125 Silver		
	DSI 128 Clay		
	DSI 131 Ninety Bronze		



Assembled Matching Gate Frames Can Be Purchased Separately





Caring Service 866-787-7881
Monday thru Friday, 8 AM - 5:30 PM Central

Home Acoustic Panels Applications Contact Us

Live Chat View Cart Check Out

Product Categories

- ATS Acoustic Panels
- ATS Acoustic Art Panels
- Custom Acoustic Panels
- ATS Acoustic Baffles
- Bass Traps & Stackers
- ATS Acoustic Diffusers
- DIY Acoustic Materials
- ATS Ceiling Panels
- Accessories
- Clearance Items

Help & Information

- Request a Quote
- Application Information
- Color Chart
- Swatches & Samples
- FAQ's
- Track Your Order
- ATS Acoustics Blog



Home > [ATS Acoustic Baffles](#)

ATS Acoustic Baffles

About ATS Acoustic Baffles

- Instead of attaching to a wall, baffles are suspended from high ceilings.
- Baffles are often used in auditoriums, gyms, sports arenas, commercial/industrial buildings, and other large spaces.
- Baffles are more efficient than wall panels because both sides of the baffle absorb sound.

Built to Last

- ATS Acoustic Baffles are built around an aluminum frame, just inside the fabric.
- This frame ensures crisp, square edge lines that last. Some baffles look like bags or pillows over time, that won't happen here.
- The frame also provides superior durability and resistance to damage during and after installation. Occasional high-flying basketballs? No problem.



Superior Core Material

- Core material is 6 lb. per cubic foot mineral wool board. Many other baffles are built around 1 or 2 lb material. This extra density provides superior sound absorption performance especially at low frequencies.
- Noise Reduction Coefficient (NRC) rating of 1.52. This high NRC rating means fewer baffles are required to achieve the desired sound in your space.

Available in the Following Sizes

12" x 48" 2" thickness	24" x 48" 2" thickness
	
\$59.95	\$79.95
> more info	> more info

Customer Comments



“ Big delivery from ATS Acoustics today! Can't want to unwrap it! ”

- **Kiwanda Sound Recordings, Oregon**
[More reviews and photos...](#)

More Users

Princeton University
DTS PNC Bank St.
Peter's Church

Why ATS?

- Acoustically Effective.
- Visually Attractive.
- Sensibly Priced.
- Made in the USA. 
- Always friendly service.
- Easy Shipping via UPS.
- [Reviews and photos...](#)

PLAT OF SURVEY

LEGAL DESCRIPTION
 LOT 2 IN DOWNERS PARK, BEING A RESUBDIVISION OF PINE HILLS UNIT NUMBERS 1 AND 2, BOTH BEING SUBDIVISIONS IN THE NORTHWEST 1/4 OF SECTION 28, TOWNSHIP 38 NORTH, RANGE 11 EAST OF THE THIRD PRINCIPAL MERIDIAN, ACCORDING TO THE PLAT THEREOF RECORDED SEPTEMBER 14, 1979 AS DOCUMENT R79-83345, IN DuPAGE COUNTY, ILLINOIS.

LEGEND

- ⊕ HANDICAP PARKING SPACE
- (XXX.XX) RECORD DIMENSION, IF DIFFERS FROM MEASURED
- W.D.A.E. WATER DETENTION AREA EASEMENT
- U.E. UTILITY EASEMENT
- B.S.L. BUILDING SETBACK LINE

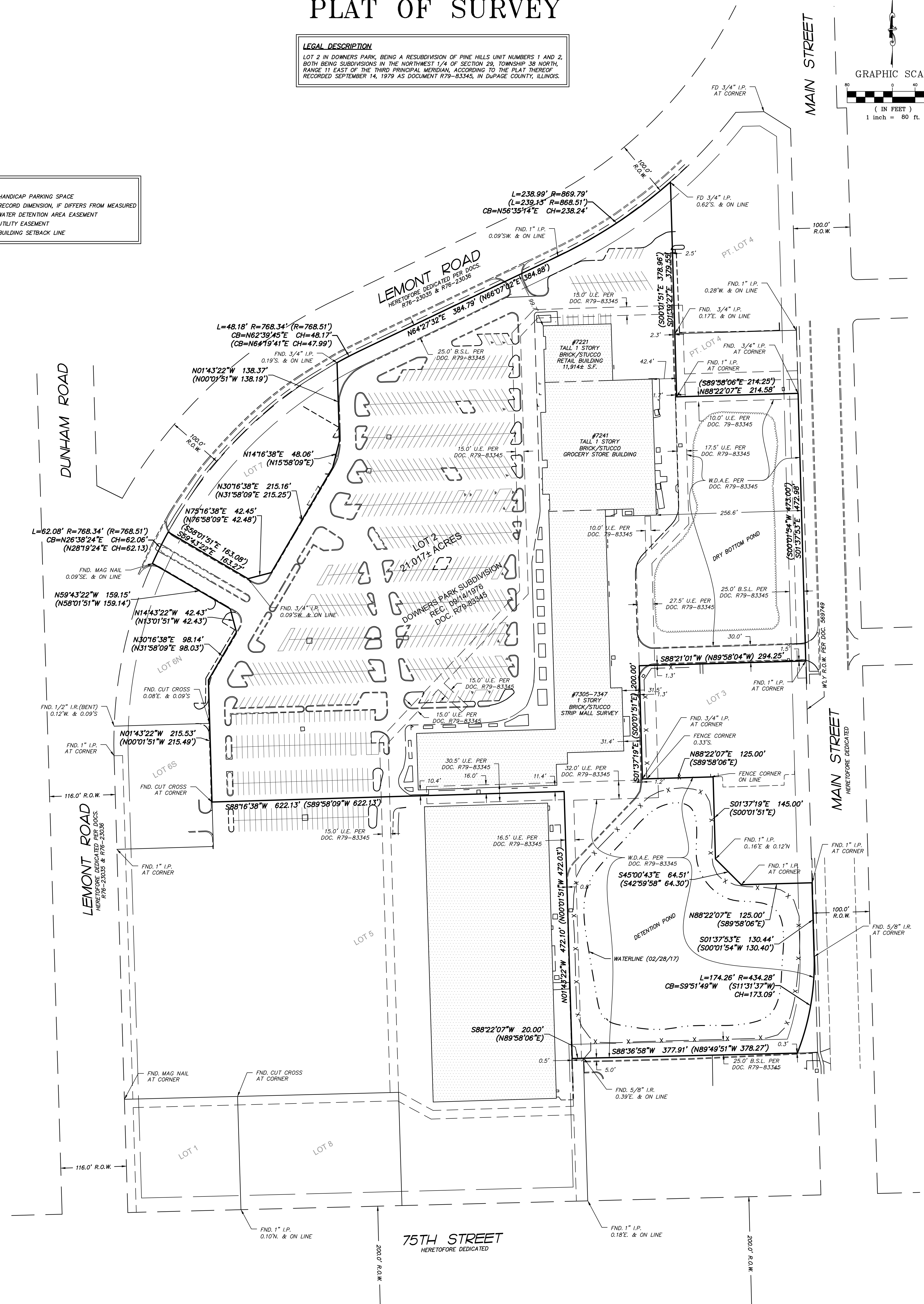
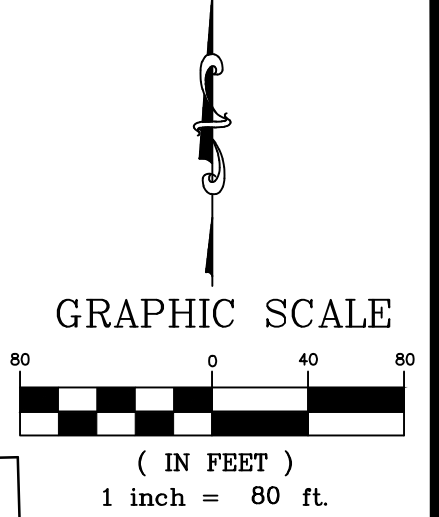

NOTE: Only those Building Line Restrictions or Easements shown on a Recorded Subdivision Plat are shown hereon unless the description ordered to be surveyed contains a proper description of the required building lines or easements.
 * Basis of bearings for this survey: IL SPC - EAST ZONE (NAD83-2011)
 * No distance should be assumed by scaling.
 * No underground improvements have been located unless shown and noted.
 * No representation as to ownership, use, or possession should be hereon implied.
 * This Survey and Plat of Survey are void without original embossed or red colored seal and signature affixed.
 * Field work for this survey was completed on 02/28/2017
 * This professional service conforms to the current Illinois minimum standards for a boundary survey and was performed for:
 DOWNERS GROVE 764, LLC
 Compare your description and site markings with this plat and AT ONCE report any discrepancies which you may find.
 3/2/2017 12:57:46 PM
 J:\2017\170130\Survey\Drawings\pos-170130-Lot2.dwg

MISCELLANEOUS NOTES

- SURVEY IS BASED IN PART ON COMMITMENT FOR TITLE INSURANCE NO. 320-833710, BY FIRST AMERICAN TITLE INSURANCE COMPANY, BEARING AN EFFECTIVE DATE OF JANUARY 10, 2017.
- ONLY EASEMENTS APPEARING ON DOWNERS PARK SUBDIVISION, PER DOC. R79-83345 ARE SHOWN HEREON. FURTHER ENCUMBRANCES APPEARING IN SCHEDULE B OF THE TITLE COMMITMENT ARE NOT SHOWN HEREON.
- ONLY BUILDING, PAVEMENT, CURBING, PARKING STRIPES AND CONCRETE IMPROVEMENTS HAVE BEEN SHOWN HEREON. EVIDENCE OF UTILITIES HAVE NOT BEEN SHOWN ON THIS SURVEY.

SURVEYOR'S CERTIFICATE
 STATE OF ILLINOIS)
 COUNTY OF KENDALL) S.S.
 THIS PROFESSIONAL SERVICE CONFORMS TO THE CURRENT ILLINOIS MINIMUM STANDARDS FOR BOUNDARY SURVEYS.
 DATED AT YORKVILLE, KENDALL COUNTY, ILLINOIS, MARCH 2, 2017, A.D.
 BEAR GREEN, INC.
PRELIMINARY
 BERNARD J. BAUER, P.L.S. (bbauer@hrgreen.com)
 ILLINOIS PROFESSIONAL LAND SURVEYOR NO. 3799
 LICENSE EXPIRATION DATE: 11/30/2018
 FIELDWORK COMPLETED: 02/28/2017

DRAWN BY: BJB
 APPROVED: MRF
 JOB DATE: 03/02/2017
 JOB NO: 170130

BAR IS ONE INCH ON OFFICIAL DRAWINGS
 0" = 1"
 IF NOT ONE INCH, ADJUST SCALE ACCORDINGLY

Illinois Professional Design Firm # 184-001322
 651 Prairie Pointe Drive, Suite 201,
 Yorkville, Illinois 60560
 t. 630.553.7560 f. 630.553.7646
 www.hrgreen.com

PLAT OF SURVEY
LOT 2 IN DOWNERS PARK SUBDIVISION
DOWNERS GROVE, DuPAGE COUNTY, ILLINOIS

NO.	DATE	BY	REVISION DESCRIPTION

SHEET
1 OF 1

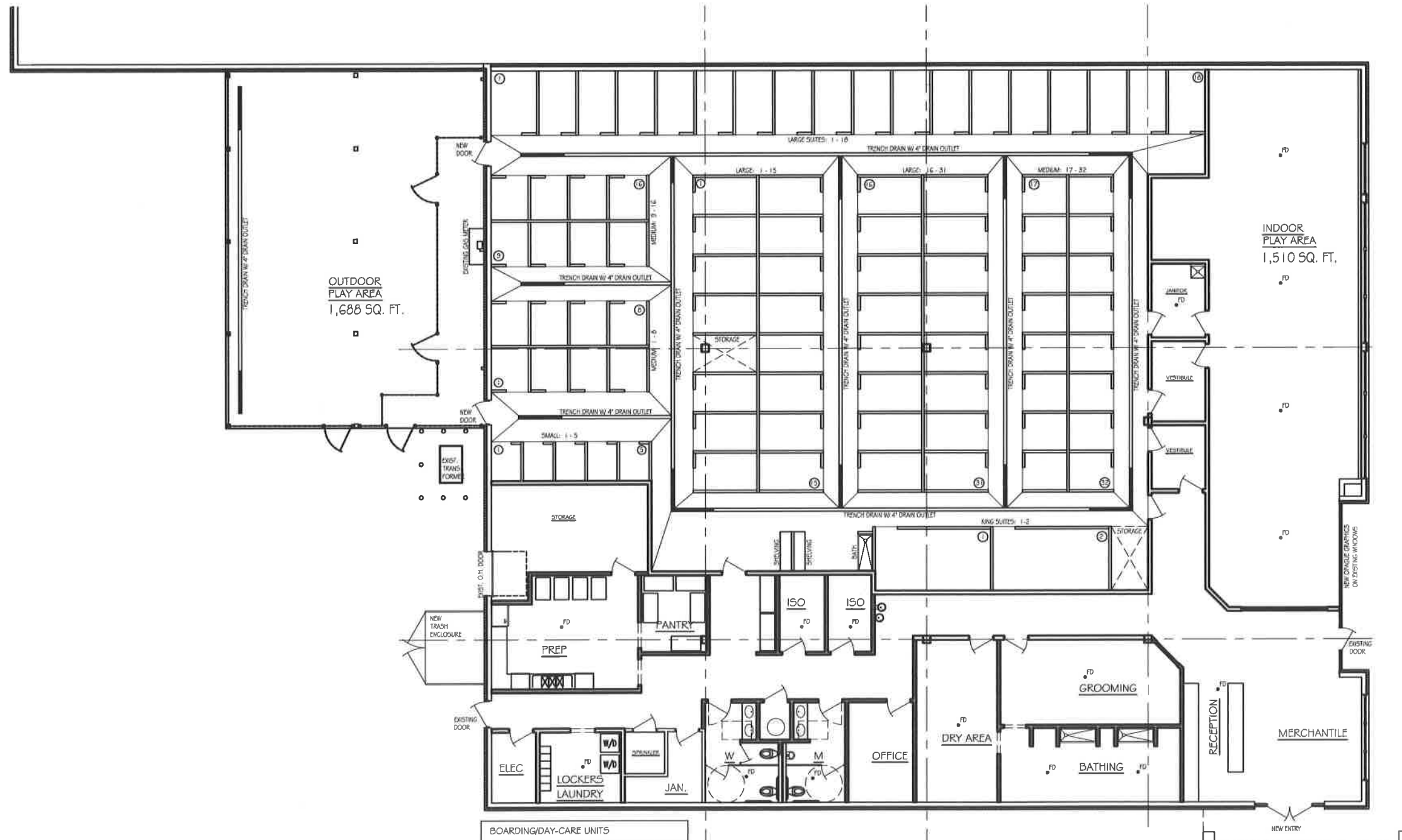

BOARDING/DAY-CARE UNITS	
SMALL (60' X 48')	5
MEDIUM (68' X 60')	32
LARGE (100' X 60')	31
LARGE SUITES (100' X 60')	18
KING SUITES (100' X 188')	2
TOTAL UNITS	88

FLOOR PLAN

SCALE: 1/16" = 1'-0"
 EXISTING TENANT SPACE = 11,920 SQ. FT.

Pete & Mac's Pet Resort
 7221 Lemont Road, Downers Grove, Illinois 60516

studio21 architects
 911 Rogers Street
 Downers Grove, IL 60515
 630.789.2513
 studio21architects.com

DATE: 03/03/17

PROJECT: 16279

SHEET: A2.0

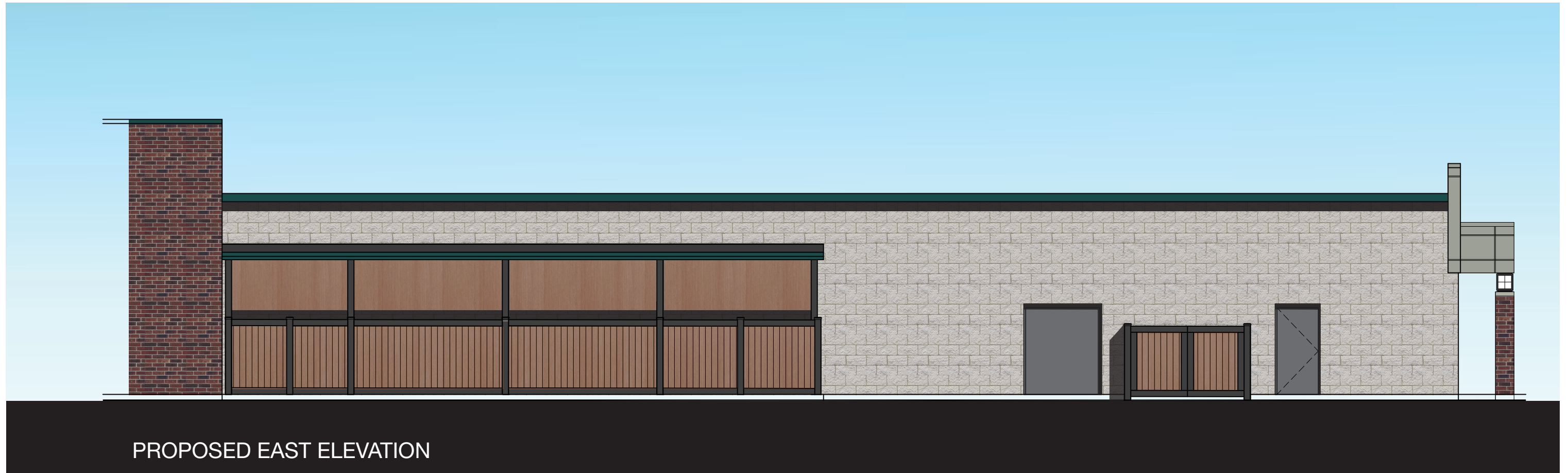

7221 Lemont Road - Existing Photos



West Facade



East Facade



North Facade



North Facade - Proposed new entry location

17PLC0004 - Submitted

Pete & Mac's Pet Resort - Proximity to neighbors

Based on Parcel Navigator

7225 Main St – property directly east of outdoor play area

386' to property line

421' to home

1011 Pinewood Place – property directly to north

433' to property line

445' to rear of townhome

1043 Pinewood Place – property to north, slightly west

346' to property line

350' to townhome

Other outdoor dog areas

The Dog Spot - 909 Ogden Ave

Property line adjacent to dog area

22' from house to dog area

Doggie Depot – 635 Rogers St

147' to closest property line

258' to rear of closest home

63rd & Main

Adjacent to property line

Estimated 130' to rear of house

DRAFT

FILE 17-PLC-0005: A petition seeking approval of a Special Use to allow an animal boarding facility. The property is zoned B-2, General Retail Business District. The property is located south of Lemont Road, 220 feet southwest of the intersection of Lemont Road and Main Street, commonly known as 7221 Lemont Road, Downers Grove, IL (PIN 09-29-110-007). Pete & Mac's Pet Resort, Petitioner; Kimco Realty, Owner.

Village Planner, Swati Pandey, reviewed her staff report regarding the special use for an animal boarding facility and located the site on the overhead map and referenced the plat of survey with surrounding zoning. The site map was referenced.

Proposed is a daycare/animal boarding/grooming and training facility in the existing 12,000 sq. foot former Walgreens building. The business is proposed to be open 7 days per week, 8:00 AM to 5:00 PM with 24 hour staffing and a maximum occupancy of 35 pets. No changes will occur to the building's façade or parking lot. An outdoor pet play area is proposed on the west side of the building. Specialized turf and noise baffles will address noise. A new trash enclosure is proposed that meets regulations. The proposed use meets the parking requirements, per the zoning ordinance. A new entry doorway is planned for the north façade and a floor plan depicts occupancy for 88 units for pet occupancy. A review of the building's interior followed by staff. Elevations of the building also followed, noting no significant changes.

Reference to the village's zoning map and land use map were noted, with Ms. Pandey explaining that the property is zoned B2 General Retail Business and is identified as Corridor Commercial in the village's Future Land Use Map and no major land use changes were being proposed in the near future. It was pointed out was that one of the goals for the property was to attract a mix of uses that provide services to local residents and the region, as cited in the Comprehensive Plan and its draft update. The standards for approval for Special Use Criteria Section 28.12.050.H have been met. Staff recommended a positive recommendation to the Village Council subject to staff's conditions.

The chairman invited commissioner questions.

Ms. Gassen asked for clarification of an animal boarding facility within the zoning ordinance, as it relates to daytime boarding versus overnight boarding. Ms. Pandey stated the zoning ordinance distinguishes between grooming (a permitted use) and does not distinguish specifically daycare, but discusses overnight boarding.

Asked how long the building space was vacant, Ms. Leitschuh stated a couple of years. Asked what the noise decibel level rating is at the lot line, Ms. Pandey stated for daytime at the residential property, maximum allowable decibel level was 65 and for night time it was 50 decibels. If the noise ordinance was violated, could the applicant lose its special use permit, wherein Ms. Pandey indicated they could, as with anything applied as part of the special use application.

Regarding the outdoor covered area and runoff from the soiled turf, Chairman Rickard inquired of staff where it was collected, i.e., the storm sewer? Ms. Pandey deferred to the applicant but

DRAFT

surmised it was part of property maintenance. Ms. Leitschuh indicated that such disposal would have to meet approval from the sanitary district.

Mr. Quirk inquired about the location of the sound baffles which staff addressed.

Petitioner, Ms. Gay Barwald, President and Chief Operating Officer for Pete & Mac's Pet Resort reviewed some statistics of the growing industry as well as the story behind Pete n Mac's and its five current locations. Her business was not a franchise. Ms. Barwald described how her managers move up through the business and the training they receive. Tours of the facility are always open and client hours are from 6:30 AM to 7:00 PM, Monday thru Friday; Saturdays 8:00 AM to 5:00 PM and Sunday 8:00 AM to 6:00 PM. Further details of her business were shared.

Services available included overnight (short & long-term) lodging, daycare, theme parties, Paws & Crafts Days, full service groom and spa, and obedience training – a full service pet resort. Ms. Barwald described the levels of staff training, surveillance of the facility, emergency evacuation plans, and a van on-site for transport. The outside play area included six-foot fence with a turf system and will be used as an emergency evacuation area. Details of the interior followed. There will be a flush system installed within the building which will tie the daycare flush into the building so that it is flushing into city sewers. Hospital grade/EPA registered cleaning products will be used and an air ventilation system will turn the air in the building four to six times per hour.

Photographs of the "suites" were shown on the overhead. An explanation followed on how the turf would be cleaned, how the noise baffles were constructed, and end of day slow downs. Ms. Barwald stated she has done noise studies noting traffic noise from a quarter mile was 70 decibels; outdoor pet noise was 62 decibels. Photographs followed. Grooming and spa services were explained.

Ms. Hogstrom asked how many dogs were typical to be outside, wherein Ms. Barwald indicated it depended upon the day, knowing that it gets busier toward the end of the week. Maximum number allowed outside was 35 pets from 8:00 AM to 3:00 PM.

Ms. Barwald explained that the automatic flush system (trench drain) will be added and tied into the building with waste in order to flush it out of the daycare area and into the sanitary sewer. Ms. Leitschuh proceeded to correct her previous answer and explained that if the applicant has a system that is going to be tied into the sewer system, the village's stormwater engineer will be reviewing it prior to permit.

Asked whether the other facilities were all located in shopping centers, Ms. Barwald explained her building was in "the heart" of retail in Avondale, Arizona and residential in Gilbert, Arizona. Asked if noise complaints were ever issues, Ms. Barwald indicated in the negative.

Mr. Maurer shared some decibel data he "Googled" from Purdue University and asked the applicant if she could provide some data (or anecdotal) from the manufacturer of the sound baffles. Ms. Barwald said she could provide it but did not have it handy, stating she has used the

DRAFT

baffles before and have hung them inside the boarding area. Her staff is trained to control the barking.

Asked how many of the 88 rooms are occupied for daycare, Ms. Barwald stated 35 are occupied. Asked what percent was used for long-term boarding, short-term, etc., Ms. Barwald explained that boarding was seasonal. During Christmas, 80% of the rooms will be for long-term boarding\.

Asked who would enforce noise issues, Ms. Leitschuh explained that it would be a neighbor complaint with the police to respond. Further details followed on how the special use would be removed if it became a consistent offense. Neighbors were the enforcement.

Mr. Maurer, referring to the baffles product included in the applicant's packet, pointed out the product was used for interior spaces and that the applicant was using the product for outside, wherein Ms. Barwald indicated she has used them at their Arizona facility because they sit within the overhang of the roof and fence line.

Per a question, Ms. Barwald confirmed the exterior roof was a solid material.

Per Mr. Boyle's question about daily vehicle trips, Ms. Barwald confirmed that the parking was on the north side of the building in order to drop off the dogs and contain them in that area.

Chairman Rickard invited public comment.

Ms. Marvin Schaar, 909 Rob Roy Place, Downers Grove, read his notes opposing the petition because the petition created an outdoor play area enclosed by a fence and was located east of the building. He shared his concern for noise, its negative effect on the residents, home values, and the large number of dogs allowed. He shared that once the commissioners make their decision it will permanently shift the neighborhood from being quiet to one of noise and the homeowners will have the burden to ask for compliance. Having walked his neighborhood, he stated many homes will be adversely affected by the noise coming from the outdoor play area, specifically those 27 homes located directly across the outdoor play area. He asked the commissioners to change places with those homeowners.

As for the criteria to approve the special use, Mr. Schaar discussed the third criteria and explained that the commission not only looks to the welfare of the shopping center tenant but to all of its citizens. He and his wife believed the petition, as drafted, was "significantly detrimental" to their welfare and they were permitted to enjoy their outdoor space during daylight hours, especially during the weekends without barking dogs. In support of the second criteria of the special use, Mr. Schaar, stated the criteria discusses providing a community need for quality care for dogs in the area. He stated the company could provide the same service to the community by providing an indoor play area versus an outdoor. He cited, as an example, the Pet Smart located at 75th and Lyman which had four indoor play areas. Given the cold weather here, he stated an indoor play would be a positive.

DRAFT

He respectfully opposed the petition, but stated that if the facility were to have an indoor play area, as a condition, he and his wife would not oppose the petition.

Ms. Judy Marks, a resident on Claremont Drive, Downers Grove, near Pinewood Drive, shared a story about a dog that was barking in her neighborhood and how the sound carried throughout the area with her thinking the dog was in her backyard, which it was not. She voiced concern about noise in her quiet neighborhood, additional traffic to the site, it being a strange location for a dog grooming/daycare facility and sewer/drainage backup. She opposed the facility.

Ms. Mary Ellen Mercy, 7209 Webster, lives behind the proposed facility, stated she has two dogs, one of which is louder than the other. She appreciated her neighbors' patience. However, she stated if an animal runs across her yard or if the dog behind her home starts barking, her dog will "wake up the whole neighborhood." She also could not imagine how 88 boarded dogs could not go out to eliminate after 8:00 PM. She noted other dog spas existed around the village that were in non-residential areas, except for Cedar Lanes, which was in a residential area and the dogs could be heard barking. Lastly, she stated her neighborhood was at the end of Downers Grove and asked that the commissioners respect the established neighborhood. She did not want the residents to lose their property value, be upset with barking dogs, nor having to call the police.

Mr. Jerry Hollman, 834 72nd Street, Downers Grove reiterated their neighborhood was wonderful and the residents wanted to maintain the quality of the neighborhood. He pointed out a number of dog owners were negligent in handling their dogs when they transport them to different places. He suggested the commissioners visit the Pet Smart store in Darien and view the parking lot. The store offers boarding, dog care and vet care. He did not believe such businesses should be located in strip malls due to health issues, especially near a grocery store. He believed they should be located in a stand-alone building for those reasons.

Mr. Jeff McGill, 1040 Pinewood, lives about two doors shy of the north entranceway and mentioned he ran into the petitioner and the architect today. He stated that at today's meeting there were some concerns raised that he was not aware of, such as the hours of operation and the number of dogs allowed. He now shared concerns that from 6:30 AM to 8:00 AM it would be noisy across the street from him. He supported the idea of an indoor play area but it did not solve the entry problem. While he believed it was a wonderful business, there was something that needed to be said about vacancies in strip values, which also affected property values. He did not support the petition.

Mr. James Schloss, 814 Old Orchard Avenue, confirmed with staff that there was no veterinary service on site. He asked the commissioners to describe how the village planned to make revenue from the business, wherein the chairman relayed that was not part of the commission's purview. Mr. Schloss stated that if the business generated low revenue then the petition should be denied. He further explained that the area businesses were retail and there appeared to be a challenge with the strip mall west, on Lemont Road, and would continue to be a challenge. He also asked the commission whether the businesses in the same mall were aware of the petition. The chairman stated businesses within 250 feet are notified and staff pointed out that two signs were advertising the public hearing. Mr. Schloss asked the commissioners to oppose the petition

DRAFT

as it was inconsistent with the other businesses and it was an agricultural business. If the petition were to move forward he asked that the outdoor play area be fully enclosed to ease residents' concerns.

Mr. Richard Weglars, 1036 73rd Street, said he is a disabled Vietnam veteran with PTSD and any unexpected or loud noises lands him in the hospital and back to Hines Veterans Hospital. He expressed concern about the ventilation of the proposed facility going into the Shop & Save grocery store next-door and did not want that store to move out because they were harmed by a business that should not be next-door to them. He has been a realtor in town for 41 years and stated the proposed business would negatively affect property values in the area.

Mr. Eugene Poulin, 907 Applegate Avenue, Downers Grove, lived in the village for 86 years and had many dogs over the years -- indoor and outdoor for security -- and also had a poultry and livestock feed business on Ogden Avenue opposite the Omega restaurant. He shared the same concerns raised by the residents, concern about the safety of the animals, the residents, and their comfort. He pointed out that there was no mention of a sprinkler system being retrofitted for the building and there was only one proper exit at the north end of the building, should an emergency evacuation occur.

Ms. Cindy Tory, 7217 Webster St., Downers Grove, discussed the location of her home in relation to the outdoor play area and stated there were several homes on Webster where there was nothing blocking the homes from the proposed outdoor play area. She opposed the facility due to the noise and because she works from her home and it would be a challenge. Her husband, who was a veterinarian, but not in attendance, opposed the facility. She shared the same concerns as stated tonight, voiced concern about negative property values, and potentially losing the Shop & Save grocery store. The facility would also negatively affect the nearby women's shelter.

Ms. Elanta Schmengda (phonetic spelling), 7220 Orchard Place, moved to her home three years ago and if she knew there was a nearby dog facility she would not have purchased her home. She moved to Downers Grove from Chicago to have peace and quiet. She voiced concern that many truck deliveries take place at the Shop & Save and the dogs will hear those deliveries and be making more noise. She voiced concern about smell, traffic, the costs associated with a "resort" facility and the people who will use such service, and property values. She opposed the facility.

Mr. John DeWolf, 10600 W. Higgins, Rosemont, IL on behalf of Kimco Realty, and owner of the shopping center, explained that he was the one who negotiated the lease with Shop & Save. He has spoken with the grocery store owner about the proposal to ensure that the owner was "on board" and had no major concerns. Some of the concerns were already resolved by relocating the entrance to the north of the proposed facility and speaking to references of Pete & Mac's. Furthermore, Mr. DeWolf added that he has been involved with real estate for 20 years and with Kimco Realty for 10 years, focusing mainly on grocery-anchored shopping centers. He said he is seeing more grocery-anchored shopping centers going to the service side versus retail. He supported the proposed facility.

DRAFT

Ms. Susan and Emil Lesniak, 912 Applegate, were strongly opposed to the proposal because currently Applegate was “really quiet” and would not be quiet anymore with the proposed facility. The location did not make sense. Her concerns included noise, health issues, rodents, smell, quality of life, the burden being on the residents to call the police, traffic, allergies, food storage, property values, and security should a dog get off its leash.

Mr. Lesniak, 912 Applegate, inquired as to how much waste does 88 dogs generate daily and how would it be disposed – inside or outside? He also voiced concern about the smell from that waste, property values, and additional traffic.

Mr. Jeff McGill, 1040 Pinewood, returned and stated that 65 decibels was meaningless in the absence of any other sound. By itself, however, 65 decibels was significant. He also stated he did speak to the grocery store manager last week who was concerned about the proposal.

Ms. Barbara Goldenstein, 7221 Webster, agreed with her neighbors’ statements and added that the neighborhood has a lot of dogs and when one barks it sets off the rest of them. Regarding health and drainage, she emphasized that Applegate Street is constantly flooded, along with Webster, and she believed it was an unhealthy plan.

Ms. Doris Chalman, 7216 Orchard Place, agreed with the comments being stated and she and her husband opposed the proposal. Her first thought was the noise issues and the other being the facility being located next to a grocery store. She believed it should be a stand alone business.

Mr. Jerry Hollman, 834 72nd Street, returned and, again, stated his concern about dog waste in the parking lots. He corrected an earlier statement regarding flooding on Applegate, noting it was not flooding but was designed storm water overflow and anything on the ground that gets into the stormwater system was a health risk.

Mr. Emil Lesniak, 912 Applegate Ave., pointed out that in the applicant’s presentation there was mention that an owner could pick up a dog anytime. He asked what exactly did that mean?

Hearing no further public comment, the chairman invited the petitioner to respond.

Mr. Bill Styczinski, 221 Eighth Street, Downers Grove, architect, stated he did visit the Avondale, Arizona facility which was located in a shopping center and adjacent to residential uses, stating it worked well. He understood a lot of fears were expressed tonight but it was not what would be perceived, commenting he was before the commission for the Doggie Depot application about 6 months ago, which was an established business with an outdoor play area that was much closer to residential than the proposal. He stated Doggie Depot was relocating further down the street and there was no public concern regarding their facility. Mr. Styczinski also stated that if he had known there was this much public attendance for the proposed facility he would have held a neighborhood meeting prior.

Regarding the comment that the proposed facility was not right for its location, Mr. Styczinski reported that The Dog Spot was located on Ogden Avenue with their outdoor area adjacent to a residential property 22 feet away, which he thought was too close, and he did not know if there

DRAFT

were issues with that location. Doggie Depot was 147 feet to the closest property line and 258 feet to the rear of the closest home. Regarding the proposed facility, Mr. Styczinski stated looking at the property on Main Street it was 386 feet to the property line and 421 feet to the home. On Pinewood Place to the north it was 433 feet to the property line and 445 feet to the townhome. He stated the distances were greater for the proposed facility and the other dog facilities did not have sound baffling like Pete & Mac's, which also included a roof to contain the sound

Mr. Styczinski shared that he personally used Doggie Depot for his dog and he did not see the perceived chaos or barking that was mentioned when he dropped off his dog. While he understood there were concerns by the residents, he wanted the Plan Commission to understand that he was not aware of any constant phone calls regarding the facilities being nuisance properties. As to the sanitary concern, he stated trench drains will be throughout the facility with automatic flushes which will drain into the sanitary sewer. The outside area will drain to a central drain and flow into the sanitary sewer. He reiterated he will be working with the sanitary district and building department to meet sanitary conditions.

Applicant, Ms. Barwald returned and discussed that negligent pet owners do exist and people do police her facilities' parking lots, but her business is on top of it so complaints are not received. Further elaboration followed. As for picking up dogs 24/7, her lobby closes at 7:00 PM and will not open until the next morning. Any waste from the evening will be picked up and placed in the dumpster, which is picked up every two days by a contracted waste management company. She emphasized that she wanted to be that "good neighbor." The play area, as being proposed, was basically almost an entirely enclosed area. The roof would be solid with the baffles to fill in the empty spaces to mitigate the noise back to the building.

Ms. Barwald reiterated that she wanted to ensure the grocery store was fine with the proposed facility. Upon visiting the store, she explained the wall that backs up to the proposed facility has 24 inches of solid wall before it touches the proposed facility's wall. Mr. Barwald confirmed the facility has a sprinkler system and a door existed to the outdoor yard from the building so the dogs would never leave the building to get out to the outdoor yard. She asked that the commissioners consider her discussion, stating she is a reputable business that cares about its neighbors.

Asked how necessary was the outdoor play area, Ms. Barwald explained the indoor play area was for the small and older dogs while the larger dogs ran outside. It was for the health of the animals. She asked that the commissioners take into consideration everything she was willing to do to be that good neighbor and be a part of the village.

Mr. Bill Styczinski, project architect, returned providing last comments on the sanitary concern, pointing out that the health department is at the grocery store and full separation exists between the two facilities. The dogs arrived on the north side and did not share the same sidewalk as those patrons going to the grocery store. Lastly Mr. Styczinski stated there were separation requirements for fresh air/exhaust off the property lines.

DRAFT

Mr. Maurer asked for Mr. Styczinski to describe in more detail, the outdoor enclosure, wherein Mr. Styczinski stated the solid roof will be translucent (fiberglass material) to allow light in and to provide shelter from rain. Six feet of fence will exist and the space between the fence and roof will have offsetting baffles.

A resident indicated he wanted to discuss the ventilation issue, wherein the chairman explained that unless it was something new, such questions about ventilation and sprinklers would be reviewed during the building permit process and that the public would have other opportunities to voice their concerns, since the Plan Commission was a recommending body. The chairman and a couple of the commissioners explained to the inquiring public, the commission's purview, the next steps in the review process, and the available opportunities to voice their concerns on this matter.

Chairman Rickard closed the public hearing and invited commissioners to speak.

Per Mr. Quirk's question as to the last three special uses issued within the past five years for animal boarding facilities and how many complaints were logged against them, Ms. Leitschuh explained she had not received any code compliance issues for Cedar Lane , Doggie Depot or The Dog Spots. Even prior to Doggie Depot's relocation, she could not recall of complaints received which was across from residential. Mr. Quirk shared his own comments about violation reporting.

Responding to Ms. Johnson's questions, Ms. Leitschuh proceeded to explain how the police will refer violations of the zoning ordinance to the Code Enforcement department. There, issues will be addressed by the village code enforcement officers. Details followed.

Responding to Mr. Kulovany's question, Community Development Director Stan Popovich explained how decibel readings will take place if the village is called for one. He also explained how such violations are followed up with the last step being the revocation of the special use.

Mr. Boyle questioned the noise reduction ability of the PVC fencing and whether improvements or other options could be considered for the 80 lineal feet of PVC fencing if the noise was not reduced as well as consideration for a policy to address idling of guest vehicles.

Mr. Kulovany, referred to the meeting that took place regarding the dog facility on 63rd Street and that comments were made for it to relocate to 71st Street or to the empty Walgreen's building. He reminded the public the commission had no power to tell a private owner or tenant that they have to move to a different location but instead the commission's purview was to consider whether the applicant met the code and met the special use requirements.

Ms. Hogstrom, adding to her last comment, stated that much noise could be mitigated by landscaping the vacant lot that was for sale. In addition, a new building in the vacant lot would also mitigate noise between the proposed facility and the homeowners' homes.

DRAFT

Mr. Quirk shared his thoughts on how he felt the standards for approval were being met, as it relates to Standard Nos. 1 and 2. As for Standard No. 3, he asked for the commissioners to provide input.

Chairman Richard supported Standards Nos. 1 and 2. As for Standard 3, he indicated that 15 people spoke who felt the proposed use was detrimental based on noise and other concerns. He also shared the fact that if there was a violation, the special use could be revoked.

Mr. Quirk believed Standard No. 3 was being met, the sound level was measurable, and a significant amount of people used such facilities and there was a need for such facilities. In passing Doggie Depot, he stated he has never heard dogs barking or seen dogs loose near the facility on Ogden Avenue. And if the standard was not met, he believed items were easy to document and there were ways to take corrective actions. He believed if noise issues existed the applicant would work to mitigate them.

Mr. Kulovany referenced the information in the petitioner's packet and suggested the public read it, but he also believed the petitioner was "earnest" in trying to address the issues raised by the residents. Regarding traffic concerns, he believed Walgreens had to have more than 88 customers. He believed Standard Nos. 1 and 2 were met. As for Standard No. 3, he believed the petitioner was putting up a significant amount of money to risk losing its special use and believed that if residents were not happy they would call in to report issues. He believed the petitioner met the standard.

Regarding Standard No. 3 and the lowering of property values, Ms. Hogstrom added that brick and mortar buildings were, unfortunately, struggling to get tenants and there was such a demand for doggie daycare that she believed it was a better use than having a vacant building for so long.

Chairman Rickard referenced the six letters that were included in the packet, noting all six were opposed to the facility. [Ms. Leitschuh noted they were received after the packet was put together.] The chairman referenced staff's recommendation and its three conditions. Ms. Hogstrom recommended adding a 4th condition subject to monitoring the noise level. Dialog followed that such recommendation was addressed under the zoning ordinance and also addressed by staff.

Ms. Gassen agreed with the above comments and believed most of the concerns were addressed. If there were noise issues she encouraged the residents to take action.

The chairman entertained a motion.

WITH RESPECT TO FILE 17-PLC-0005, MS. GASSEN MADE A MOTION THAT THE PLAN COMMISSION FORWARD A POSITIVE RECOMMENDATION TO THE VILLAGE COUNCIL FOR THE SPECIAL USE REQUEST TO ALLOW THE ANIMAL BOARDING FACILITY, SUBJECT TO THE FOLLOWING THREE (3) CONDITIONS:

- 1. THE SPECIAL USE SHALL SUBSTANTIALLY CONFORM TO THE STAFF REPORT; ARCHITECTURAL DRAWINGS PREPARED BY**

DRAFT

STUDIO21ARCHITECTS DATED MARCH 3, 2017, EXCEPT AS SUCH PLANS MAY BE MODIFIED TO CONFORM TO THE VILLAGE CODES AND ORDINANCES;

- 2. THE APPLICANT SHALL APPLY FOR ALL SIGNAGE UNDER A SEPARATE PERMIT AND SHALL COMPLY WITH THE SIGN ORDINANCE; AND**
- 3. THE BUILDING SHALL BE EQUIPPED WITH AN AUTOMATIC SUPPRESSION SYSTEM AND AN AUTOMATIC AND MANUAL FIRE ALARM SYSTEM.**

SECONDED BY MR. KULOVANY. ROLL CALL:

AYE: MS. GASSEN, MR. KULOVANY, MR. BOYLE, MS. HOGSTROM, MR. MAURER, MS. JOHNSON, MR. QUIRK, CHAIRPERSON RICKARD

NAY: NONE

MOTION PASSED. VOTE: 8-0



VILLAGE OF
DOWNERS GROVE

Swati Pandey <spandey@downers.us>

Re: Petition for approval of Special Use to establish animal boarding business

Schaar, Marvin B. (US - Retired) <mschaar@deloitteired.com>

Mon, Apr 3, 2017 at 10:14 AM

To: "spandey@downers.us" <spandey@downers.us>

Cc: "Schaar, Marvin B. (US - Retired)" <mschaar@deloitteired.com>

Ms. Swati Pandey

Village Planner

Downers Grove Community Development

Re: Petition for approval of Special Use to establish animal boarding business

Dear Ms. Pandey,

We have resided in Downers Grove at 909 Rob Roy Place for the past 31 years.

This is to provide a public comment concerning the petition seeking approval of a Special Use to establish an animal boarding business at 7221 Lemont Road ("the Petition"). For the reasons discussed below, we believe that the Petition as presently drafted should not be approved.

The Petition includes an outside facility which will hold up to 35 dogs for 10 hours a day, 7 days a week. The barking noises emanating from this facility for 70 hours a week will be significantly detrimental to the welfare of the residents living in the area. Further, the noise from the facility will be injurious to the residents' property values. Dog barking from the facility will carry throughout the neighborhood. Moreover, certain residences located on Old Main Street and others located on Pinewood Drive will be particularly harmed because they will be right across from the facility.

If the Petition were modified to include only indoor play facilities, we would not oppose the Petition. With that modification, the harm caused by the noise emanating from an outdoor facility would be eliminated. Moreover, if as the Petition asserts, there would be benefit to the community from the provision of dog boarding services at this location, the same benefit would exist if the play facility were indoors, not outdoors.

For the foregoing reasons, we respectfully request that the Petition be denied.

Thank you for all your assistance with this matter.

Sincerely,

Marvin and Dawn Schaar



VILLAGE OF
DOWNERS GROVE

Swati Pandey <spandey@downers.us>

Animal boarding

John McIntosh <bluefirej7@gmail.com>
To: SPANDEY@downers.us

Sun, Apr 2, 2017 at 11:40 AM

I would like the commission to not recommend approval for the rezoning of 7221 Lemont Rd. The residents do not want to listen to dozens of dogs barking all day everyday. This would have a negative impact on the values of our homed. The kennel on dunham rd next to Obrien Park can be heard from well over 1000ft away with way fewer dogs.

Thanks,
John McIntosh

917 Rob Roy Place

Sent from my iPhone



VILLAGE OF
DOWNERS GROVE

Swati Pandey <spandey@downers.us>

Animal boarding business at 7221 Lemont Road

Bart Sak <barteksak@yahoo.com>

Sun, Apr 2, 2017 at 3:45 PM

Reply-To: Bart Sak <barteksak@yahoo.com>

To: "spandey@downers.US" <spandey@downers.us>

Hello,

I would like to voice my opposition to the planned animal boarding establishment to be located at 7221 Lemont Road. The outside play area will disturb the peace of all residents in the area.

Bartlomiej Sak
1018 Pinewood Dr.
Downers Grove, 60516
708-271-2039

From: Ken O`Connor [<mailto:koconnor@shopandsavemarket.com>]

Sent: Wednesday, April 26, 2017 11:07 AM

To: Dewolfe, John <JDewolfe@kimcorealty.com>

Subject: RE: Pete & Mac's Pet Resort for Downers Park Plaza replacing closed Walgreen's

John:

The passage by the planning commission is great news.

The ownership of Shop & Save Market reviewed the plans for this business and look forward to having them as a thriving business neighbor.

Please let us know when they will being construction.

If Pete & Mac's general contractor or ownership would like to meet with the store management to coordinate the timing of any special deliveries or construction work which might affect our regular delivery schedules it would be my pleasure to set up those introductions.

Thank you again for keeping us aware of the status of this exciting addition to the shopping center.

Sincerely,

Kenneth J. O'Connor,

Controller

Shop & Save Market

Phone [\(708\) 398-6600](tel:(708)398-6600)

Fax [\(708\) 398-6609](tel:(708)398-6609)

e-mail: koconnor@shopandsavemarket.com



Sonja Kasche
1011 Pinewood Dr.
Downers Grove, Il 60516
Pin: 0929113010

March 29, 2017

Village of Downers Grove - Plan commission
Civic Center
801 Burlington Ave
Downers Grove, Il 60515-4782

Re: PUBLIC HEARING – 7221 LEMONT RD, DOWNERS GROVE
FILE 17-PLC-0005

ATTN: PLAN COMMISSIONER

I am unable to attend this hearing for re-zoning/special use of the above stated property f/k/a Walgreens. I oppose the rezoning/ special use of this property for animal boarding facility.

1. It's a health hazard adjacent to a food/grocery store.
2. Hazardous stinking waste will be created.
3. Traffic congestion already present. Patrons with their animals are going to park next to curb.
4. Noise: Barking, yelping animals howling all night long and during day.
5. Hazards: Somebody will be bitten by one of these animals.
6. Smell: Other people may be very allergic to smell, dander and waste particles floating and fouling air.

Traffic congestion in and out of this shopping center is a big concern.

Animal boarding facilities should be anywhere where it is not adjacent to a food store.

What about all those vacant stores in "the Grove Shopping Center" where Michaels has closed down? Perfect location no food or grocery store next to it, since Ultra Food Store is closing April 18. Vacant Michael's store, corner location, accessible from 3 sides.

I would like to remind you, before "Shop & Save" Grocery Store leased the space, it took many years to find a viable grocer business to take this space. Now you want to drive business away with a "Boarding Facility for stinking animals?"

NO - TO SPECIAL USE FOR ANIMAL BOARDING!

PS – 80% of the community where I reside did not receive any notification of re-zoning / special use for a "Boarding Facility for Animals" of the former "Walgreens"!

I hope you will take my opposition into consideration!

Sonja Kasche

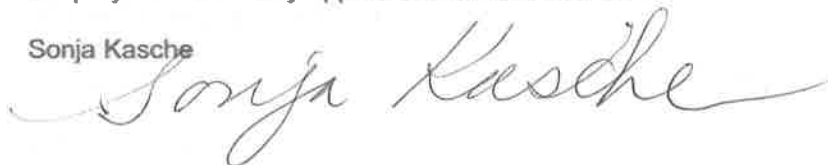



VILLAGE OF
DOWNERS GROVE

Swati Pandey <spandey@downers.us>

Animal Boarding Facility SHOULD NOT BE APPROVED

Eipe Varghese <evarghese@dudek-bock.com>

Mon, Apr 3, 2017 at 12:49 PM

To: "SPANDEY@Downers.US" <SPANDEY@downers.us>

Cc: Eipe <shibueipe@comcast.net>, Walt Sandine <wsandine@sbcglobal.net>

TO WHOM IT MAY CONCERN

THIS IS TO CONFIRM THE SUBJECT FOR TODAY'S MEETING.

WE WILL NOT BE ABLE TO MAKE IT FOR THE MEETING.

WE ARE RESIDING AT 7213 ORCHARD PL, DOWNERS GROVE, IL-60516-3825.

WE ARE LIVING IN THIS HOUSE SINCE 1981 APRIL AND WE DO NOT WANT THE NEIGHBOURHOOD TO HAVE THIS KIND OF BUSINESS ESTABLISHED, OPERATING FOR THE QUIETNESS AND PEACE TO BE MAINTAINED AROUND OUR NEIGHBOURHOOD.

NAMES:

MR. VARGHESE EIPE

And MRS. SARAMMA V. EIPE



VILLAGE OF
DOWNS GROVE

Swati Pandey <spandey@downers.us>

proposed dog facility at the old Walgreen's, 75th and Lemont

Vivian <vivgee54@aol.com>
To: SPANDEY@downers.us

Mon, Apr 3, 2017 at 3:05 PM

We live at 7208 Webster St and have been residents of Downers Grove for over 30 years. We very much object to the proposed dog business. First of all, this is a residential area. Our yard is 1 block east of Main and we would be subjected to up to 35 dogs barking all day long and a building that can house up to 88 dogs!!!! That is absurd! That type of facility needs open land, not residential space. Also, next door is a successful grocery store, Shop and Save. We do not need another business closing down in this area. We would be very disappointed in the use of our hard-earned tax dollars going to a facility that would certainly decrease our property value. We already have to deal with buyers not wanting an open classroom school (El Sierra) and we have the Family Shelter down the street. Enough is enough.

We hope you will seriously consider our objections, along with many other neighbors to the east and west of Main Street.

Ron and Vivian Grella



VILLAGE OF
DOWNERS GROVE

Swati Pandey <spandey@downers.us>

Fwd: Dog boarding business at Walgreens site on Lemont Rd.

Bob DeMeyer <robertdemeyer@comcast.net>
To: spandey@downers.us

Tue, Apr 4, 2017 at 8:40 AM

My wife Susan and I are against the dog boarding business under review for the Walgreens site on Lemont Rd.

It is the wrong location for this type of business, in a strip mall across the street from housing. It will create traffic and the outdoor dog play area will mean many hours of noise seven days a week.

This type of business needs to be in a more isolated area, not on the end of a strip mall in a busy location. And up to 88 dogs is too many in this location.

Bob and Sue DeMeyer
809 Old Orchard Ave.
Downers Grove, IL 60516
robertdemeyer@comcast.net



VILLAGE OF
DOWNERS GROVE

Swati Pandey <spandey@downers.us>

Proposed Animal Boarding Facility

Sabaliauskas, Vic <vsabaliauskas@oak-park.us>

Tue, Apr 25, 2017 at 10:07 AM

To: "SPANDEY@downers.us" <SPANDEY@downers.us>

Cc: "Rima Sabaliauskas (rima.sabaliauskas@us.bureauveritas.com)" <rima.sabaliauskas@us.bureauveritas.com>

Hello

Our address is 759 72nd St., Downers Grove. We vehemently oppose the approval/granting of the special use permit for this proposed animal boarding facility at 7221 Lemont Road. There is already quite a bit of noise impact (delivery trucks, garbage trucks trash bins, traffic, etc.) from the back of the stores in the shopping complex. The noise from this animal boarding outdoor area will resonate throughout our neighborhood every day! In addition, it could deter others from buying homes in this area thereby affecting our property values.

Please reconsider your recommendation to the Village Board to grant this special use permit.

Thank you.

Vic Sabaliauskas, LEED AP

Vic Sabaliauskas

Building Maintenance Superintendent

Village of Oak Park

Public Works Department

201 South Blvd.

Oak Park, IL 60302

Ph 708-358-5700

FAX 708-358-5711



VILLAGE OF
DOWNERS GROVE

Swati Pandey <spandey@downers.us>

Proposed Animal Boarding Facility

rima.sabaliauskas@us.bureauveritas.com <rima.sabaliauskas@us.bureauveritas.com> Tue, Apr 25, 2017 at 12:31 PM
To: SPANDEY@downers.us

To whom it may concern,

Our address is 759 72nd St., Downers Grove. We vehemently oppose the approval/granting of the special use permit for this proposed animal boarding facility at 7221 Lemont Road.

Most yards around are area are not fenced including our property (both of our neighbors property on either side of us and across the street are not fenced in). We have small children, I am not willing to take the chance one of those dogs should escape and attack our children. It is clear that they intend to have that area for their Large Dogs "outdoor play area east of the store for up to 35 larger breed dogs."

Where will these dogs be using the bathroom? That smell alone with permeate throughout our neighborhood. Not to mention the additional noise impact. We already have enough noise (delivery trucks, garbage trucks, traffic, etc.) from the back of the stores in the shopping complex. The outdoor pay area is intended to be open from 8:00 am to 6:00pm; the noise from this animal boarding outdoor area will resonate throughout our neighborhood. It will deter others from buying homes in this area thereby affecting our property values.

Please reconsider your recommendation to the Village Board to grant this special use permit.

Regards,



Rima Sabaliauskas

Large Account Supervisor

National Elevator Inspection Services, Inc.

A Bureau Veritas Company

11973 Westline Industrial Drive, Suite 100, St. Louis, MO 63146

Cell: 314-651-7484

rima.sabaliauskas@us.bureauveritas.com

www.us.bureauveritas.com

**BUREAU
VERITAS**

"This message contains confidential information. To know more, please click on the following link:"<http://disclaimer.bureauveritas.com>"



VILLAGE OF
DOWNERS GROVE

Swati Pandey <spandey@downers.us>

Re: Petition for approval of Special Use to establish animal boarding business at 7221 Lemont Road -material for first reading

Schaar, Marvin B. (US - Retired) <mschaar@deloitteired.com>
To: "spandey@downers.us" <spandey@downers.us>
Cc: "Schaar, Marvin B. (US - Retired)" <mschaar@deloitteired.com>

Tue, Apr 25, 2017 at 4:09 PM

Mayor Martin T. Tully

Commissioner Bob Barnett

Commissioner Greg Hose

Commissioner William Waldack

Commissioner Bill White

Commissioner Marge Earl

Commissioner Nicole Walus

Re: Petition for approval of Special Use to establish animal boarding business at 7221 Lemont Road

Dear Mayor and Commissioners,

We have resided in Downers Grove at 909 Rob Roy Place for the past 31 years.

This is to provide a public comment concerning the petition seeking approval of a Special Use to establish an animal boarding business for up to 88 dogs at 7221 Lemont Road in the Village. For the reasons discussed below, we strongly believe that the petition as presently drafted should not be approved.

The petition, as presently drafted, would involve utilization of a fenced outdoor play area for up to 35 dogs, mostly larger breeds, from 8am to 6pm, 7 days a week. The barking and noise from this outdoor play area would carry throughout the neighborhood and would be significant and harmful to us and the other residents in the vicinity. For this reason, the proposed animal boarding business would be significantly detrimental to our welfare and the welfare of the other residents living in the vicinity. Further, the noise from the outdoor play area would be injurious to our property values.

If the petition were modified to include only indoor play facilities, we would not oppose the petition. With that modification, the harm caused by the noise emanating from an outdoor play area would be eliminated. Moreover, if as the petition asserts, there would be benefit to the community from the provision of dog boarding services at this location, the same benefit would exist if the play facilities were indoors, not outdoors.

For the foregoing reasons, we respectfully request that the petition as presently drafted be denied.

Sincerely,

Marvin and Dawn Schaar



VILLAGE OF
DOWNERS GROVE

Swati Pandey <spandey@downers.us>

Animal Boarding Business

Dan Ryan <DRyan@icsecurity.com>

Thu, Apr 27, 2017 at 3:24 PM

To: "mayorcouncil@downers.us" <mayorcouncil@downers.us>, "SPANDEY@Downers.us" <SPANDEY@downers.us>

Cc: "deekayryan@aol.com" <deekayryan@aol.com>

Dear Council,

I am writing this from my place of employment. My wife Kay and I have lived in Downers Grove since 1985. We are located at 7209 Lyman Ave. We had the house built and we are comfortable. This is great place to live and we are very happy to be residents. Recently, we became of plans to establish an animal boarding business on the corner of 72nd and Main Street at the site of what was a Walgreens Store.

We are not opposed to commerce in the area but we share the concerns of our neighbors who worry about the noise generated by animals that would be roaming inside the proposed fenced play area which, as we understand it, is to be located east of the old Walgreens building. If the proprietors of this establishment wish to locate their business in this area, we believe the "play area" needs to be located in the parking lot west of the building which, as you are aware, is closer to the street. This may require some re-work of the parking lot but seems to us an acceptable variation that would allow a win for both sides. Thanks for reading this.

Dan Ryan

Vice President for Operations

Inter-Con Security Systems, Inc.

(O) 815-553-1185

(C) 773-640-0687

DRyan@icsecurity.com|www.icsecurity.com



VILLAGE OF
DOWNERS GROVE

Swati Pandey <spandey@downers.us>

Proposed Animal Boarding Facility in Downers Grove

Sharon Skibbe <sharonskibbe@sbcglobal.net>

Thu, Apr 27, 2017 at 3:36 PM

Reply-To: Sharon Skibbe <sharonskibbe@sbcglobal.net>

To: "mayorcouncil@downers.us" <mayorcouncil@downers.us>, "spandey@downers.us" <spandey@downers.us>

Hello,

We are writing to you to express our opposition to the establishment of an animal boarding business with an outdoor play area at the vacant storefront on Main Street near 75th Street in Downers Grove, previously a Walgreens Drug Store. We are residents of Downers Grove and live in close proximity to this proposed business. We understand, the Downers Grove Planning Commission has already recommended that a special use permit be granted for this facility. We are strongly opposed to this and do not feel a business of this sort belongs in a residential area.

Specifically, we are worried about the barking and noise that this business would create and how it will affect our peaceful neighborhood. We enjoy being outside and certainly would not be able to enjoy the quietness of nature when up to 35 dogs could potentially be in an outside enclosed area just blocks from our home, anytime from 8am til 6pm, 7 days a week. That particular location is adjacent to a grocery store and we know that large trucks will be making deliveries and causing the dogs to become agitated and begin barking. In addition to the supermarket, there is currently an auto repair shop which will also have various noises generated from air compressor tools which will spook the dogs and cause them to be disruptive with their barking. Also, we are not sure how a facility of this sort plans to walk up to 35 dogs each day back and forth to the play area with a busy parking lot full of grocery shoppers. The potential of dogs getting loose and causing many hazards for the driving public in the area as well as the shoppers to the area would be highly likely. Please take time to think about this proposed business and how it will negatively affect the neighborhood. How would you feel if it was coming to your neighborhood?

Please be mindful of our neighborhood and it's residents. There is no place for an animal boarding business at this location. It is much to close to both a quiet residential neighborhood and a public shopping area. We both have signed a petition against this business and hope you will truly consider our concerns.
Sharon and Dave Skibbe

----- Forwarded message -----

From: <noreply-webserver@downers.us>

Date: Thu, May 4, 2017 at 2:05 PM

Subject: [downers.us website] Council & Director Request

To: spopovich@downers.us

Cc: lnelson0709@gmail.com

First Name : **Laura**

Last Name : **Curry**

Email : lnelson0709@gmail.com

Send To : **6893**

Description: **My family resides at 7425 Webster St. and we oppose the dog boarding facility proposed at the old Walgreens site on Lemont Rd. We are frequent users of boarding facilities for our own dog and do not believe the proposed site would provide appropriate accommodations. Most dogs are anxious in a boarding setting and the amount of traffic/noise in that area already, paired with lack of green space, make it an unsuitable location for dogs.**

I shop at Shop N Save frequently but would question food safety should there be a dog boarding facility next door due to possible contamination from pet waste, parasites, etc.

Lastly, the neighborhood will suffer from increased noise, waste and foul smells.

Thank you

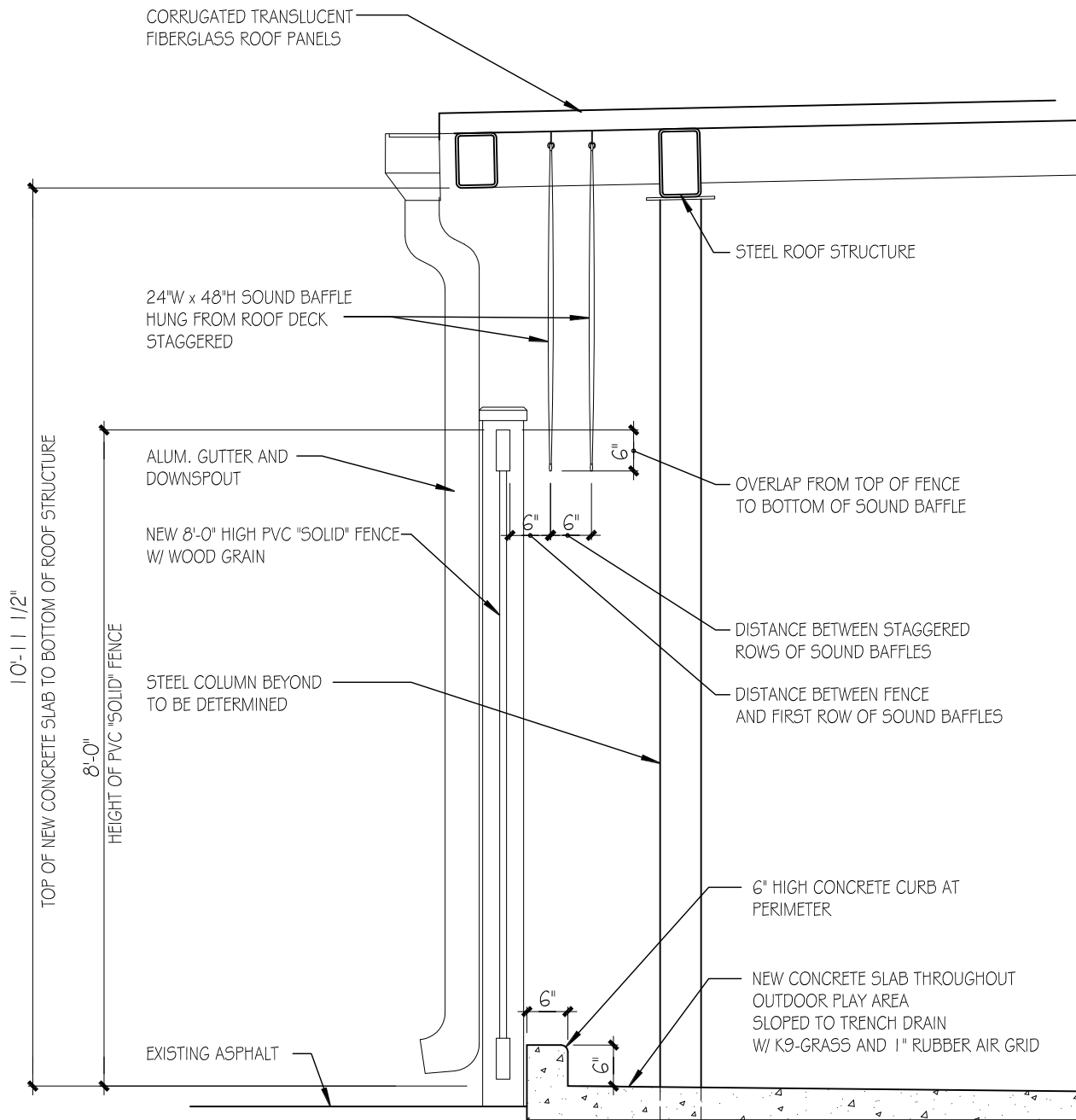

SECTION THRU PERIMETER FENCE OF OUTDOOR AREA
 1
 SCALE: 1/2" = 1'-0"

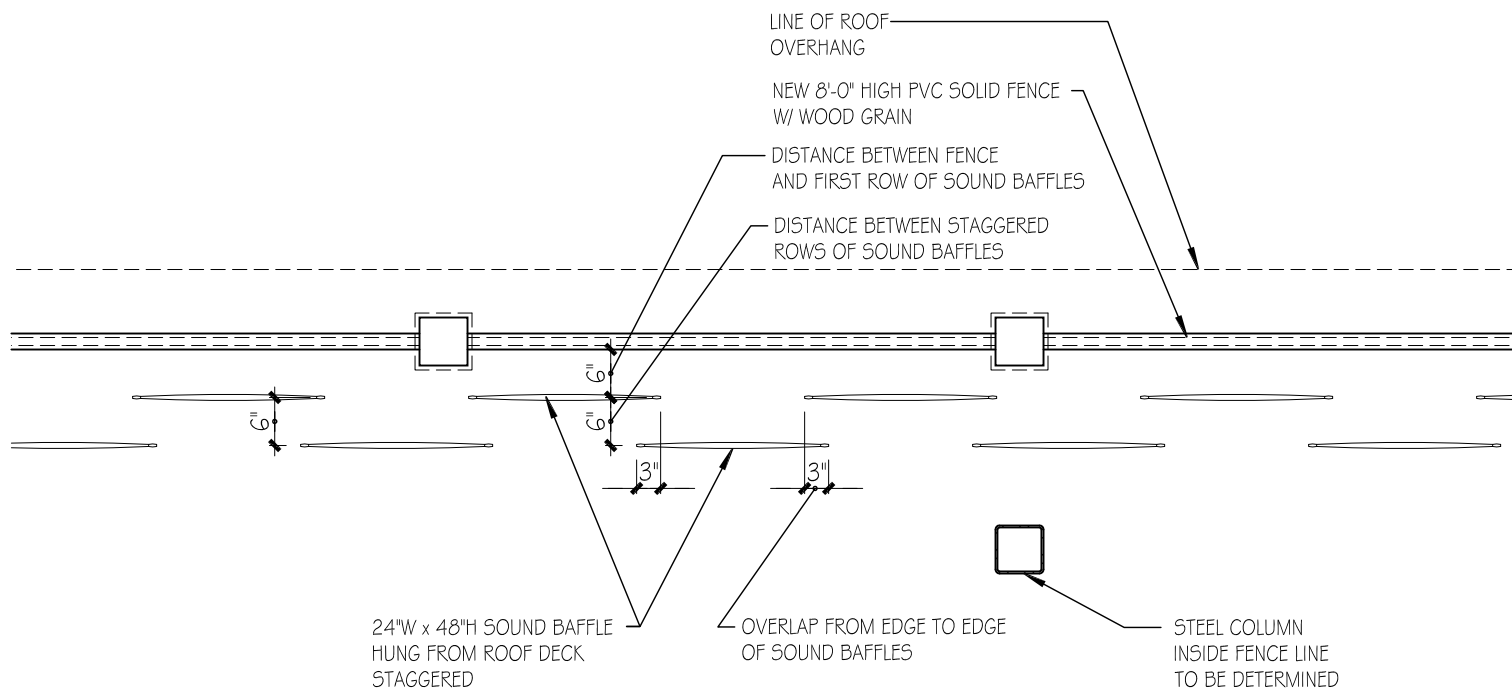

2 PLAN VIEW OF PERIMETER FENCE OF OUTDOOR AREA

SCALE: 1/2" = 1'-0"

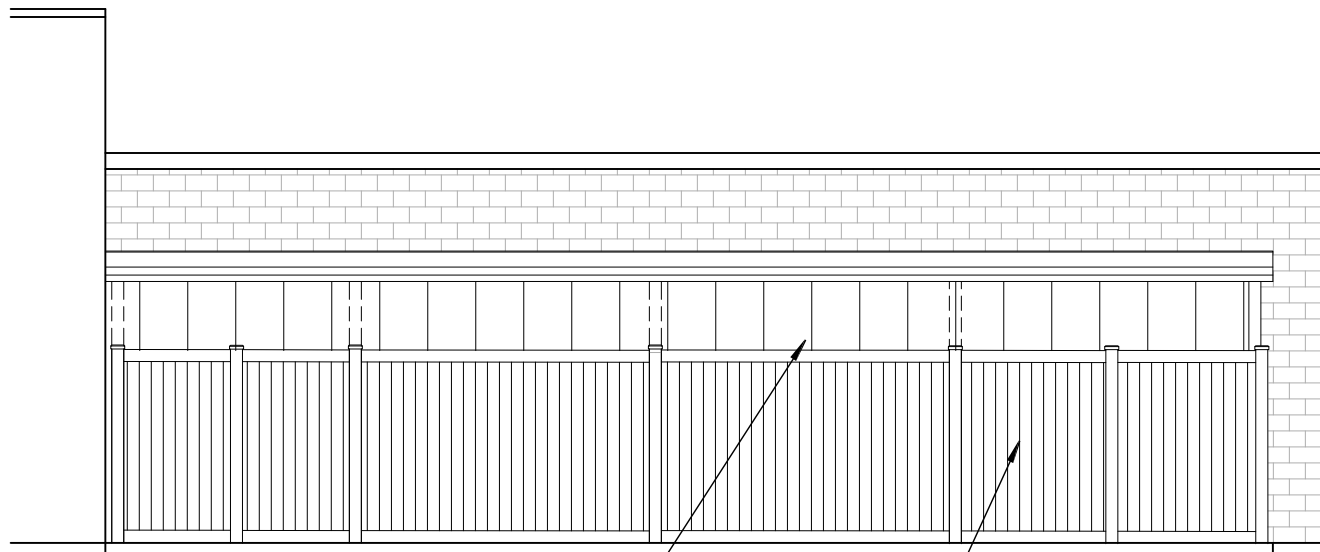

OFFSET SOUND BAFFLES
BETWEEN TOP OF
FENCE AND ROOF TO
MATCH FENCE COLOR

NEW 8'-0" PVC SOLID FENCE
W/ WOOD GRAIN

OUTDOOR PLAY AREA
EAST ELEVATION

SCALE: 1/8" = 1'-0"

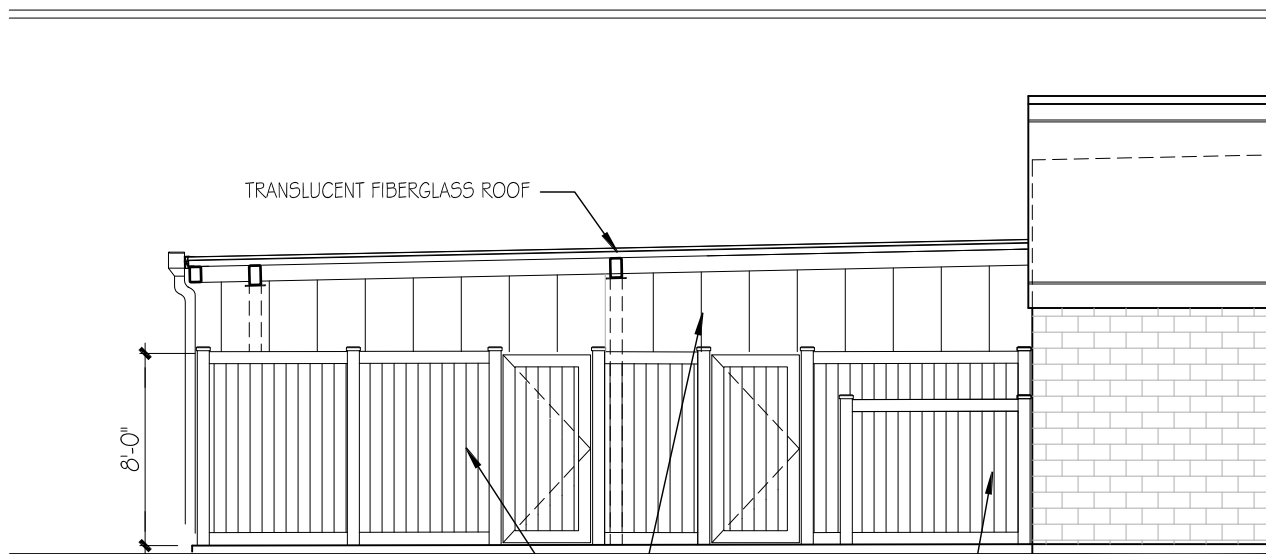

TRANSLUCENT FIBERGLASS ROOF

8'-0"

NEW 8'-0" HIGH PVC SOLID FENCE
W/ WOOD GRAIN

OFFSET SOUND BAFFLES
BETWEEN TOP OF
FENCE AND ROOF TO
MATCH FENCE COLOR

NEW 6'-0" HIGH PVC FENCE
W/ WOOD GRAIN
SURROUND FOR
TRASH ENCLOSURE

OUTDOOR PLAY AREA
NORTH ELEVATION

SCALE: 1/8" = 1'-0"

Pete & Mac's Pet Resort
7221 Lemont Road, Downers Grove, Illinois 60516

911 Rogers Street
Downers Grove, IL 60515

630.789.2513
studio21architects.com



DATE
05/11/17

PROJECT
16279

SHEET
A4.3