

VILLAGE OF DOWNERS GROVE

Report for the Village

SUBJECT:	SUBMITTED BY:
1434 Butterfield Road - Planned Unit Development, Zoning Map Amendment and Special Use	Stan Popovich, AICP Director of Community Development

SYNOPSIS

The petitioner is requesting approval of a Planned Unit Development, a Zoning Map Amendment from B-3, General Services and Highway Business to B-3/PUD, General Services and Highway Business/Planned Unit Development, and a Special Use to construct and operate a drive-through at 1434 Butterfield Road.

STRATEGIC PLAN ALIGNMENT

The goals for 2025-2027 include *Strong, Diverse Local Economy*.

FISCAL IMPACT

N/A

RECOMMENDATION

Approval on the February 3, 2026 active agenda per the Planning and Zoning Commission's 6:0 positive recommendation. The Planning and Zoning Commission found that the proposal is compatible with the Comprehensive Plan and meets all standards for approval for a Zoning Map Amendment, the establishment of a Planned Unit Development, and a Special Use found in Sections 28.12.030, 28.12.040, and 28.12.050 of the Municipal Code.

BACKGROUND

Property Information and Zoning Request

The petitioner is proposing to construct a drive-through coffee shop and related parking lot improvements at 1434 Butterfield Road. The property is located at the northeast corner of the intersection of Butterfield Road and Downers Drive and is zoned B-3, General Services Highway Business. The building is located in the southern half of the parking lot. The coffee shop provides no seating and includes a canopy over the pick-up area. The petitioner will be installing additional landscape islands within their drive-through lane and throughout the existing parking lot which will increase the amount of green space on the property.

Access to the drive-through lane is through the existing parking lot. Access to the parking lot is via a signalized intersection along Downers Drive and a connection, both at the northern end of the parking lot, to the adjacent shopping center which has a right-in/right-out along Butterfield Road. The drive-through lane is designed to accommodate 39 vehicles with overflow stacking available within the existing parking lot.

Compliance with the Comprehensive Plan

The Guiding DG Comprehensive Plan's Future Land Use Map designates the subject property as Regional Commercial. Regional Commercial uses are defined as commercial uses that provide goods and services that draw patrons from within, and beyond Downers Grove. Retail businesses in this area benefit from visibility and access without significantly contributing to traffic along the corridor or impact on nearby residential areas. The plan also recommends repurposing parts of parking lots for outlot development to better leverage land for sales tax-generating uses.

Compliance with the Zoning Ordinance

The subject property is zoned B-3, General Services Highway Business. The petitioner is requesting a Planned Unit Development, Zoning Map Amendment, a Special Use to construct and operate a drive-through at 1434 Butterfield Road. The bulk requirements of the proposed building in the B-3 zoning district are summarized in the Planning and Zoning Commission Staff Report.

Public Comment

Prior to the Planning & Zoning Commission meeting, there were no public comments received by Staff. One resident spoke at the meeting in support of the proposal.

ATTACHMENTS

Aerial Map

Ordinances



Staff Report with attachments dated January 5, 2026

Draft Planning and Zoning Commission Minutes dated January 5, 2026



0 62.5 125 Feet

1434 Butterfield Road Location Map

-  Subject Property
-  Site Location

ORDINANCE NO. _____

**AN ORDINANCE AUTHORIZING A SPECIAL USE FOR
1434 BUTTERFIELD ROAD TO PERMIT A DRIVE-THROUGH**

WHEREAS, the following described property, to wit:

PARCEL 1:

LOT 1 IN OAK GROVE CENTRE OF COMMERCE UNIT ONE, BEING A SUBDIVISION OF PART OF THE EAST 1/2 OF SECTION 30, TOWNSHIP 39 NORTH, RANGE 11, EAST OF THE THIRD PRINCIPAL MERIDIAN, ACCORDING TO THE PLAT THEREOF RECORDED FEBRUARY 7, 1972 AS DOCUMENT NO. R72-6195, IN DUPAGE COUNTY, ILLINOIS.

PARCEL 2:

THAT PART OF LOT 2 DESCRIBED AS BEGINNING AT THE NORTHWEST CORNER OF SAID LOT 2; THENCE SOUTH 01 DEGREE 04 MINUTES 56 SECONDS EAST ALONG THE WESTERLY LINE OF SAID LOT 2 A DISTANCE OF 245.61 FEET TO A POINT; THENCE NORTH 88 DEGREES 55 MINUTES 04 SECONDS EAST ALONG A LINE PERPENDICULAR TO THE WESTERLY LINE OF SAID LOT 2 A DISTANCE OF 66 FEET TO A POINT; THENCE NORTH 01 DEGREE 04 MINUTES 56 SECONDS WEST ON A LINE PARALLEL TO THE WEST LINE OF LOT 2, A DISTANCE OF 243.42 FEET TO THE NORTH LINE OF SAID LOT 2; THENCE NORTH 89 DEGREES 10 MINUTES 46 SECONDS WEST ALONG THE NORTH LINE OF SAID LOT 2 A DISTANCE OF 66.04 FEET TO THE POINT OF BEGINNING, ALL IN OAK GROVE CENTRE OF COMMERCE, UNIT 1 BEING A SUBDIVISION OF PART OF THE EAST 1/2 OF SECTION 30, TOWNSHIP 39 NORTH, RANGE 11, EAST OF THE THIRD PRINCIPAL MERIDIAN, ACCORDING TO THE PLAT THEREOF RECORDED FEBRUARY 7, 1972 AS DOCUMENT NO. R72-6195, IN DUPAGE COUNTY, ILLINOIS.

PARCEL 3:

PERPETUAL, NON-EXCLUSIVE EASEMENTS FOR THE BENEFIT OF PARCELS 1 AND 2 AS CREATED BY CONSTRUCTION OPERATION, MAINTENANCE AND RECIPROCAL EASEMENT AGREEMENT BY AND BETWEEN NATIONAL BOULEVARD BANK OF CHICAGO, AS TRUSTEE UNDER TRUST AGREEMENT DATED DECEMBER 22, 1970 AND KNOWN AS TRUST NUMBER 3632, DROVER'S BANK OF CHICAGO, AS TRUSTEE UNDER TRUST AGREEMENT DATED JANUARY 22, 1980 KNOWN AS TRUST NUMBER 80012 AND NATIONAL BOULEVARD BANK OF CHICAGO, AS TRUSTEE UNDER TRUST AGREEMENT DATED MARCH 24, 1978 KNOWN AS TRUST NUMBER 5994, DATED NOVEMBER 27, 1982 AND RECORDED JUNE 10, 1982 AS DOCUMENT NO. R82-23852 FOR THE PEDESTRIAN AND VEHICULAR TRAFFIC OVER THE FOLLOWING DESCRIBED FIVE (5) EASEMENTS:

EASEMENT PARCEL:

THE NORTHERLY 180 FEET OF THE FOLLOWING DESCRIBED PARCEL: THAT PART OF LOT 2 IN OAK GROVE CENTRE OF COMMERCE, UNIT 1, DESCRIBED AS FOLLOWS: COMMENCING AT THE NORTHWEST CORNER OF SAID LOT 2; THENCE

SOUTH 01 DEGREE 04 MINUTES 56 SECONDS EAST, ALONG THE WEST LINE OF SAID LOT, A DISTANCE OF 245.61 FEET TO THE POINT OF BEGINNING; THENCE CONTINUING SOUTH 01 DEGREE 04 MINUTES 56 SECONDS EAST ALONG SAID WEST LINE A DISTANCE OF 116.0 FEET; THENCE NORTH 88 DEGREES 55 MINUTES 04 SECONDS EAST, A DISTANCE OF 16 FEET; THENCE NORTH 01 DEGREE 04 MINUTES 56 SECONDS WEST, A DISTANCE OF 92.0 FEET; THENCE NORTH 88 DEGREES 55 MINUTES 04 SECONDS EAST, A DISTANCE OF 74 FEET; THENCE NORTH 01 DEGREE 04 MINUTES 56 SECONDS WEST, A DISTANCE OF 266.62 FEET TO A POINT ON THE NORTHERLY LINE OF SAID LOT 2; THENCE NORTH 89 DEGREES 10 MINUTES 46 SECONDS WEST ALONG THE NORTHERLY LINE OF SAID LOT 2, A DISTANCE OF 24.01 FEET; THENCE SOUTH 01 DEGREE 04 MINUTES 56 SECONDS EAST A DISTANCE OF 243.42 FEET; THENCE SOUTH 88 DEGREES 55 MINUTES 04 SECONDS WEST A DISTANCE OF 66 FEET TO THE POINT OF BEGINNING, ALL IN OAK GROVE CENTRE OF COMMERCE, UNIT 1, BEING A SUBDIVISION OF PART OF THE EAST 1/2 OF SECTION 30, TOWNSHIP 39 NORTH, RANGE 11, EAST OF THE THIRD PRINCIPAL MERIDIAN, IN DUPAGE COUNTY, ILLINOIS.

EASEMENT PARCEL:

THE FOLLOWING DESCRIBED PARCEL, EXCEPT THE NORTH 180 FEET THEREOF: THAT PART OF LOT 2 IN OAK GROVE CENTRE OF COMMERCE, UNIT 1, DESCRIBED AS FOLLOWS: COMMENCING AT THE NORTHWEST CORNER OF SAID LOT 2; THENCE SOUTH 1 DEGREE 04 MINUTES 56 SECONDS EAST ALONG THE WEST LINE OF SAID LOT, A DISTANCE OF 245.61 FEET TO THE POINT OF BEGINNING; THENCE CONTINUING SOUTH 1 DEGREE 04 MINUTES 56 SECONDS EAST ALONG SAID WEST LINE A DISTANCE OF 116.0 FEET; THENCE NORTH 88 DEGREES 55 MINUTES 04 SECONDS EAST, A DISTANCE OF 16 FEET; THENCE NORTH 1 DEGREE 04 MINUTES 56 SECONDS WEST, A DISTANCE OF 92.0 FEET; THENCE NORTH 88 DEGREES 55 MINUTES 04 SECONDS EAST, A DISTANCE OF 74 FEET; THENCE NORTH 1 DEGREE 04 MINUTES 56 SECONDS WEST, A DISTANCE OF 266.62 FEET TO A POINT ON THE NORTHERLY LINE OF SAID LOT 2; THENCE NORTH 89 DEGREES 10 MINUTES 46 SECONDS WEST ALONG THE NORTHERLY LINE OF SAID LOT 2, A DISTANCE OF 24.01 FEET; THENCE SOUTH 1 DEGREE 04 MINUTES 56 SECONDS EAST A DISTANCE OF 243.42 FEET; THENCE SOUTH 88 DEGREES 55 MINUTES 04 SECONDS WEST A DISTANCE OF 66 FEET TO THE POINT OF BEGINNING, ALL IN OAK GROVE CENTRE OF COMMERCE, UNIT 1, BEING A SUBDIVISION OF PART OF THE EAST 1/2 OF SECTION 30, TOWNSHIP 39 NORTH, RANGE 11, EAST OF THE THIRD PRINCIPAL MERIDIAN, IN DUPAGE COUNTY, ILLINOIS.

EASEMENT PARCEL X: INTENTIONALLY DELETED.

EASEMENT PARCEL Y: INTENTIONALLY DELETED.

EASEMENT PARCEL Z:

THAT PART OF LOTS 2 AND 3 IN OAK GROVE CENTRE OF COMMERCE, UNIT 1, DESCRIBED AS FOLLOWS: COMMENCING AT THE NORTHWEST CORNER OF LOT 2; THENCE SOUTH 1 DEGREE 04 MINUTES 56 SECONDS EAST ALONG THE WEST LINE OF SAID LOT 2, 361.61 FEET TO THE POINT OF BEGINNING; THENCE NORTH 88 DEGREES 55 MINUTES 04 SECONDS EAST, 359.78 FEET TO THE POINT OF CURVE; THENCE 69.77 FEET EASTERLY ALONG A CURVE CONCAVE NORTHERLY, HAVING A RADIUS OF 178.01 FEET (CHORD BEARING NORTH 77 DEGREES 41 MINUTES 20 SECONDS EAST AND A DISTANCE OF 69.33 FEET) TO A POINT OF REVERSE CURVE; THENCE EASTERLY 69.77 FEET ALONG A CURVE CONCAVE SOUTHERLY, HAVING A RADIUS OF 178.01 FEET (CHORD BEARING NORTH 77 DEGREES 41 MINUTES 20 SECONDS EAST AND A DISTANCE OF 69.33 FEET) TO POINT OF TANGENT; THENCE NORTH 88 DEGREES 55 MINUTES 04 SECONDS EAST, 207.75 FEET TO POINT OF CURVE; THENCE SOUTHERLY 47.12 FEET ALONG A CURVE CONCAVE SOUTHWESTERLY, HAVING A RADIUS OF 30 FEET (CHORD BEARING SOUTH 46 DEGREES 04 MINUTES 56 SECONDS EAST AND A DISTANCE OF 42.43 FEET) TO POINT OF TANGENT, SAID POINT BEING ON A LINE 170 FEET WEST OF AND PARALLEL TO THE EAST LINE OF LOT 3; THENCE SOUTH 1 DEGREE 04 MINUTES 56 SECONDS EAST ALONG THE AFORESAID PARALLEL LINE 247.90 FEET TO A POINT ON THE SOUTHERLY LINE OF LOT 3; THENCE SOUTH 81 DEGREES 54 MINUTES 34 SECONDS WEST ALONG THE SOUTHERLY LINE OF LOT 3, 35.26 FEET; THENCE NORTH 1 DEGREE 04 MINUTES 56 SECONDS WEST, 227.21 FEET TO POINT OF CURVE; THENCE NORTHERLY 31.42 FEET ALONG A CURVE CONCAVE SOUTHWESTERLY, HAVING A RADIUS OF 20 FEET (CHORD BEARING NORTH 46 DEGREES 04 MINUTES 56 SECONDS WEST AND A DISTANCE OF 28.28 FEET), TO POINT OF TANGENT; THENCE SOUTH 88 DEGREES 55 MINUTES 04 SECONDS WEST, 182.75 FEET TO POINT OF CURVE; THENCE WESTERLY 56.05 FEET ALONG A CURVE CONVEX NORTHERLY HAVING A RADIUS OF 143.01 FEET (CHORD BEARING SOUTH 77 DEGREES 41 MINUTES 20 SECONDS WEST AND A DISTANCE OF 55.70 FEET) TO POINT OF REVERSE CURVE; THENCE WESTERLY 83.49 FEET ALONG A CURVE CONVEX SOUTHERLY HAVING A RADIUS OF 213.01 FEET (CHORD BEARING SOUTH 77 DEGREES 41 MINUTES 20 SECONDS WEST AND A DISTANCE OF 82.96 FEET) TO POINT OF TANGENT; THENCE SOUTH 88 DEGREES 55 MINUTES 04 SECONDS WEST, 359.78 FEET TO A POINT ON THE WEST LINE OF LOT 2; THENCE NORTH 1 DEGREE 04 MINUTES 56 SECONDS WEST ALONG THE WEST LINE OF LOT 2, 35 FEET TO THE POINT OF BEGINNING, ALL IN OAK GROVE CENTRE OF COMMERCE, UNIT 1, BEING A SUBDIVISION OF PART OF THE EAST 1/2 OF SECTION 30, TOWNSHIP 39 NORTH, RANGE 11, EAST OF THE THIRD PRINCIPAL MERIDIAN, IN DUPAGE COUNTY, ILLINOIS.

Commonly known as: 1434 Butterfield Road, Downers Grove, IL 60515
PIN: 06-30-404-010; -011

(hereinafter referred to as the "Property") is presently zoned in the "*B-3/PUD, General Services and Highway Business District/Planned Unit Development*" under the Comprehensive Zoning Ordinance of the Village of Downers Grove; and

WHEREAS, the owner of the Property has filed with the Planning and Zoning Commission, a written petition conforming to the requirements of the Zoning Ordinance, requesting that a Special Use per Section 28.12.050 of the Zoning Ordinance be granted to allow a drive-through.

WHEREAS, such petition was referred to the Planning and Zoning Commission of the Village of Downers Grove, and said Planning and Zoning Commission has given the required public notice, has conducted a public hearing for the petition on January 5, 2026 and has made its findings and recommendations, all in accordance with the statutes of the State of Illinois and the ordinances of the Village of Downers Grove; and,

WHEREAS, the Planning and Zoning Commission has recommended approval of the Special Use, subject to certain conditions; and,

WHEREAS, the Village Council finds that the evidence presented in support of said petition, as stated in the aforesaid findings and recommendations of the Planning and Zoning Commission, is such as to establish the following:

(1) that the proposed use is expressly authorized as a special use in the district in which it is to be located;

(2) that the proposed use will not, in the particular case, be detrimental to the health, safety, or general welfare of the community;

(3) that the proposed use will not be injurious to the use and enjoyment of other property in the immediate area for the purposes already permitted, nor substantially diminish or impair property values within the neighborhood;

(4) that the establishment of the special use will not impede the normal and orderly development and improvement of adjacent property for uses permitted in the district.

NOW, THEREFORE, BE IT ORDAINED by the Council of the Village of Downers Grove, in DuPage County, Illinois, as follows:

SECTION 1. That Special Use of the Property is hereby granted to allow a drive-through.

SECTION 2. This approval is subject to the following conditions:

1. The Planned Unit Development, Rezoning and Special Use shall substantially conform to the staff report dated January 5, 2026; architectural drawings prepared by Veritas Architecture & Design last revised on November 11, 2025; engineering drawings prepared by Toth & Associates dated December 9, 2025, and photometric drawings prepared by Red Leonard Associates dated September 19, 2025 except as such plans may be modified to conform to the Village codes and ordinances.
2. A plat of easement shall be provided by the developer to establish the proposed utility easements shown on the engineering drawings prepared by Toth & Associates dated December 9, 2025.

SECTION 3. The above conditions are hereby made part of the terms under which the Special Use is granted. Violation of any or all of such conditions shall be deemed a violation of the Village of Downers Grove Zoning Ordinance, the penalty for which may include, but is not limited to, a fine and/or revocation of the Special Use granted herein.

SECTION 4. It is the Petitioner's obligation to maintain compliance with all applicable Federal, State, County and Village laws, ordinances, regulations, and policies.

SECTION 5. That all ordinances or parts of ordinances in conflict with the provisions of this ordinance are hereby repealed.

Mayor

Passed:

Published:

Attest: _____

Village Clerk



**VILLAGE OF DOWNERS GROVE
REPORT FOR THE PLANNING & ZONING COMMISSION
JANUARY 5, 2026 AGENDA**

SUBJECT:	TYPE:	SUBMITTED BY:
25-PZC-0034 1434 Butterfield Road	Planned Unit Development, Zoning Map Amendment and Special Use	Carter Moran, Planner

REQUEST

The petitioner is requesting approval for a Planned Unit Development, a Zoning Map Amendment from B-3, General Services and Highway Business to B-3/PUD, General Services and Highway Business/Planned Unit Development, and a Special Use to construct and operate a drive-through at 1434 Butterfield Road.

NOTICE

The application has been filed in conformance with applicable procedural and public notice requirements.

GENERAL INFORMATION

OWNERS: Alpine Income Property Op
1140 N Williamson Blvd, Ste 14
Daytona Beach, FL 32114

PETITIONER: Sarah Wilkerson
Toth & Associates
1550 E. Republic Road
Springfield, MO 65804

PROPERTY INFORMATION

EXISTING ZONING: B-3, General Services and Highway Business
EXISTING LAND USE: Shopping Center
PROPERTY SIZE: 321,378 sq. ft. (7.38 acres)
PINS: 06-30-404-010, -011

SURROUNDING ZONING AND LAND USES

	ZONING	FUTURE LAND USE
NORTH:	M-2, Restricted Manufacturing	Light Industrial/Business Park
SOUTH:	B-3, General Services and Highway Business	Regional Commercial
EAST:	B-3, General Services and Highway Business	Regional Commercial
WEST:	B-3, General Services and Highway Business	Regional Commercial

ANALYSIS

SUBMITTALS

This report is based on the following documents, which are on file with the Department of Community Development:

1. Project Narrative
2. Entitlement Criteria
3. Plat of Survey
4. Architectural Plans
5. Engineering Plans
6. Landscape Plan
7. Traffic Impact Study
8. Stormwater Report
9. Sign Plan
10. Photometric Plan

PROJECT DESCRIPTION

The petitioner is proposing to construct a drive-through coffee shop and related parking lot improvements. The 7.38-acre property is located at the northeast corner of the intersection of Butterfield Road and Downers Drive and is zoned B-3, General Services Highway Business.

The petitioner is requesting the following approvals:

- Final Planned Unit Development (PUD) Approval
- Zoning Map Amendment from B-3 to B-3/PUD
- Special Use for a Drive-Through

The petitioner is proposing to improve the subject property by constructing a new 1,172 square foot drive-through coffee shop. The PUD request is necessary in order to place two buildings on the subject property and to grant the associated deviations as discussed below. The proposed coffee shop has no seating inside or outside. Additional improvements include a canopy extending from north to south from the employee entrance to the drive-through pick-up area, as well as a trash enclosure to serve the coffee shop. Parking for employees exists on the subject property to the north and east of the proposed building. The building façade will be composed of brick in light grey and dark grey colors, as well as blue, black, and grey metal paneling across the canopy and roofline.

The petitioner is proposing new landscape islands at the end of each existing parking row for the overall shopping center. Landscaping will also be provided in and around the island created by the installation of the drive-through lane and building. The creation of parking lot islands requires the petitioner to restripe accessible parking spaces at the north side of the parking lot closest to the existing tenant buildings. With the proposed improvements the petitioner will increase the open space percentage on the shopping center, which will increase from 10.8% of the subject property to 13.6%.

Parking lot and site lighting is provided around the proposed development. A photometric plan has been submitted identifying that the proposed lighting complies with the Village requirements. The proposed building will be served by the existing parking lot access from a signalized intersection with Downers Drive. Additional access is provided via a connection to the shopping center to the east which has right-in/right-out access onto Butterfield Road. Once the building, drive-through lane, and parking lot improvements are constructed, the shared parking lot will contain 320 spaces, a reduction from the existing 379 spaces currently provided on the subject property.

COMPLIANCE WITH THE COMPREHENSIVE PLAN

The Guiding DG Comprehensive Plan's Future Land Use Map designates the subject property as Regional Commercial. Regional Commercial uses are defined as commercial uses that provide goods and services that draw patrons from within, and beyond Downers Grove. Retail businesses in this area benefit from

visibility and access without significantly contributing to traffic along the corridor or impact on nearby residential areas. The petitioner is proposing to improve the site with a drive-through coffee establishment. The coffee shop is projected to have regional draw and attract commuters moving to, from, and throughout Downers Grove.

Economic Development – Continue Investment in the Butterfield and Finley Road Area

- Ensure that the Butterfield Road corridor is resilient to changing commercial and office market conditions.
- Maintain quality of life for the corridor’s residents and ensure access to businesses and jobs.
- Promote in-line or outlot developments along the Butterfield Road Corridor.
- Promote shared parking arrangements between neighboring commercial developments to maximize space and efficiency.
- Re-evaluate parking needs and regulations for commercial and office properties to allow for creative placemaking and reuse of underutilized surface parking lots.
- Repurpose parts of parking lots for outlot development to better leverage land for sales tax-generating uses.
- Continue to partner with private developers to promote and reposition existing commercial centers to adapt to evolving retail habits and consumer preferences and enhance economic vitality.
- Leverage the unique location of this corridor adjacent to two highways to attract new retail and office tenants.

Land Use and Development - Land Use Plan

- Commercial uses should be located in areas with a regional draw of a corridor where they will benefit from access and visibility without significantly contributing to traffic or impact on nearby residential areas.

The proposed request is consistent with the Guiding DG Comprehensive Plan.

COMPLIANCE WITH ZONING ORDINANCE

The property is currently zoned B-3, General Services and Highway Business. The proposal calls for a rezoning to a B-3/PUD, General Services and Highway Business/Planned Unit Development zoning district. The bulk requirements of the proposed development in the B-3 zoning district are summarized in the following table:

Table 1: 1434 Butterfield Road – Drive-through Lot Bulk Regulations

Building	Requirement	Proposed
Butterfield Road Setback (South)	25 ft.	97.27 ft.
Downers Drive Setback (West)	25 ft.	168 ft.
Parking		
Butterfield Road Setback (South)	25 ft.	23.75 ft. [^]
Downers Drive Setback (West)	25 ft.	10 ft. [^]
Other		
Floor Area Ratio (Proposed Building)	0.75 (max)	0.003
Building Height (Proposed Building)	60 ft. (max)	20.5 ft.
Drive-Through Stacking Spaces (Proposed Building)	8 spaces	39 spaces (18 additional overflow stacking spaces)
Open Space (Entire Shopping Center)	10%	13.6%
Parking Spaces (Shopping Center)	382 spaces	320 spaces [*]

[^] Existing Nonconformity

^{*} Deviation from Zoning Ordinance

The following improvements require relief from the Zoning Ordinance regulations:

Table 2: Deviation Requests and Petitioner' Rationale

Improvement	Relief Request	Petitioner's Rationale
Trash Enclosure	Requirement: May not be located within street yard <i>Proposed: Located between Downers Drive and the proposed building</i>	The proposed development will result in public benefits greater than development under conventional zoning regulations. It is infeasible to move this enclosure any further north.
Parking Stalls	Requirement: PUD total parking stalls: 382 <i>Proposed PUD total parking stalls: 320</i>	The PUD promotes flexibility in development that would not be possible under standard zoning. Converting the outlot from existing parking stalls will require a PUD.
Two structures on one lot	Requirement: Only one primary structure per lot <i>Proposed: Two structures on one lot of record</i>	The redevelopment of the outlot with two (2) buildings will require a PUD.

Planned Unit Development Request

A Planned Unit Development is intended to accommodate development that may be difficult to carry out under applicable zoning standards and results in public benefits that are at least commensurate with the degree of flexibility provided. Examples of development types that are appropriate for PUD approval, per Section 28.4.030.A.1 of the Zoning Ordinance include:

- Developments that are consistent with the goals and policies of the Comprehensive Plan.

A PUD will also achieve a variety of planning goals as outlined in Section 28.4.030.A.2 of the Zoning Ordinance:

- Implementation of and consistency with the comprehensive plan and other relevant plans and policies;
- High-quality buildings and improvements that are compatible with surrounding areas, as determined by their arrangement, massing, form, character and landscaping;
- Flexibility and creativity in responding to changing social, economic and market conditions allowing greater public benefits than could be achieved using conventional zoning and development regulations

Signage

Signage is not part of this petition, and any signage proposed for the development shall comply with the Zoning Ordinance requirements through a separate sign permit application. The petitioner is permitted up to 70.5 square feet of total wall and ground signage and is not requesting any additional sign rea for the development. The proposed building includes wall signs on only the south and west facades which is compliant with the Zoning Ordinance.

ENGINEERING/PUBLIC IMPROVEMENTS

The petitioner's proposal complies with the Village's Stormwater and Floodplain Ordinance. The existing stormwater detention and topography throughout the parking lot are adequate to serve the proposed development. The eastern portion of the subject property is designed to hold water in cases of storm events and the proposed development will be able to convey stormwater through the basin through an overflow route. The developer proposes stormwater inlets cut into the curb along the drive-through lane. The current proposal will be reviewed for compliance with the Stormwater Ordinance during the building permit

review.

TRAFFIC AND PARKING

A traffic impact study for the proposed development was completed by the petitioner. The study examined the existing traffic conditions along Butterfield Road and Downers Drive and the future conditions based on the proposed coffee drive-through. As it exists, access to the site, including the existing tenants, is provided by a right-in/right-out point along Butterfield Road and a signaled intersection along Downers Drive, north of the proposed development. Cross access is also provided to the shopping center lot to the east. The study found that the proposed stacking for 39 vehicles within the drive-thru lanes and overflow stacking within the retail center parking lot will provide more than adequate stacking to accommodate the peak queue projected for the proposed development.

As mentioned in the petitioner's PUD request, the proposed development would reduce the quantity of provided parking spaces below the required 382 shared spaces for this shared shopping center as required by the Zoning Ordinance. The addition of landscaped parking islands at the end of all parking rows throughout the site will also benefit traffic circulation throughout the PUD. The resulting 320 parking spaces serving Golf Galaxy and Best Buy will be adequate in accommodating the estimated peak parking demands for the stores based on information published in the ITE Parking Generation Manual, 6th Edition.

PUBLIC SAFETY REQUIREMENTS

The Fire Prevention Division has reviewed the proposed development and determined that sufficient access to and around the site is provided for emergency vehicles. The site layout permits Fire Department apparatus the opportunity to access the shopping center from the Butterfield Road curb cut (located east of the subject property) or from the Downers Drive intersection.

NEIGHBORHOOD COMMENT

Notice was provided to all property owners 250 feet or less from the property in addition to posting public hearing notice signs and publishing the legal notice in the *Daily Herald*. There have been no public comments received by Staff.

STANDARDS OF APPROVAL

The petitioner is requesting a Planned Unit Development, Zoning Map Amendment, a Special Use to construct and operate a drive-through at 1434 Butterfield Road. The review and approval criteria for each request are listed below.

Planned Unit Development Request

Section 28.12.040(c)(5) Review and Approval Criteria

The decision to amend the zoning map to approve a PUD development plan and to establish a PUD overlay district are matters of legislative discretion that are not controlled by any single standard. In making recommendations and decisions regarding approval of planned unit developments, review and decision-making bodies must consider at least the following factors:

- a. The zoning map amendment review and approval criteria of Sec. 12.030.I.*
- b. Whether the proposed PUD development plan and map amendment would be consistent with the comprehensive plan and any other adopted plans for the subject area.*
- c. Whether PUD development plan complies with the PUD overlay district provisions of Sec. 4.030.*
- d. Whether the proposed development will result in public benefits that are greater than or at least equal to those that would have resulted from development under conventional zoning regulations.*
- e. Whether appropriate terms and conditions have been imposed on the approval to protect the interests of surrounding property owners and residents, existing and future residents of the PUD and the general public.*

Zoning Map Amendment Request***Section 28.12.030(i) Review and Approval Criteria for Zoning Map Amendments***

The decision to amend the zoning map is a matter of legislative discretion that is not controlled by any single standard. In making recommendations and decisions about zoning map amendments, review and decision making bodies must consider at least the following factors:

- 1. the existing use and zoning of nearby property;*
- 2. the extent to which the particular zoning restrictions affect property values;*
- 3. the extent to which any diminution in property value is offset by an increase in the public health, safety and welfare;*
- 4. the suitability of the subject property for the zoned purposes;*
- 5. the length of time that the subject property has been vacant as zoned, considering the context of land development in the vicinity;*
- 6. the value to the community of the proposed use; and*
- 7. the comprehensive plan.*

Special Use Request***Section 28.12.050(h) Special Uses –Approval Criteria***

No Special Use may be recommended for approval or approved unless the respective review or decision-making body determines that the proposed special use is consistent with and in substantial compliance with all Village Council policies and plans, including, but not limited to, the Comprehensive Plan and the Downtown Design Guidelines and that the applicant has presented evidence to support each of the following conclusions:

- (1) that the proposed use is expressly authorized as a special use in the district in which it is to be located;*
- (2) that the proposed use will not, in the particular case, be detrimental to the health, safety, or general welfare of the community;*
- (3) that the proposed use will not be injurious to the use and enjoyment of other property in the immediate area for the purposes already permitted, nor substantially diminish or impair property values within the neighborhood;*
- (4) that the establishment of the special use will not impede the normal and orderly development and improvement of adjacent property for uses permitted in the district.*

DRAFT MOTION

Staff recommends approval of the proposed Special Use, Zoning Map Amendment, and Planned Unit Development. Should the Planning & Zoning Commission find that the request is consistent with the Comprehensive Plan and meets the requirements of the Zoning Ordinance, staff has prepared a draft motion that the Planning & Zoning Commission may make for the recommendation approval of 25-PZC-0034:

Based on the petitioner's submittal, the staff report, and the testimony presented, I find that the petitioner has met the standards of approval a Planned Unit Development, a Map Amendment from B-3, General Services and Highway Business to B-3/PUD, General Services and Highway Business/Planned Unit Development, and a Special Use to construct and operate a drive-through restaurant as required by the Village of Downers Grove Zoning Ordinance and is in the public interest and therefore, I move that the Planning & Zoning Commission recommend to the Village Council approval of 25-PZC-0034, subject to the following conditions:

25-PZC-0034; 1434 Butterfield Road
January 5th, 2026

Page 7

1. The Planned Unit Development, Rezoning and Special Use shall substantially conform to the staff report; architectural drawings prepared by Veritas Architecture & Design last revised on November 11, 2025; engineering drawings prepared by Toth & Associates dated December 9, 2025, and photometric drawings prepared by Red Leonard Associates dated September 19, 2025 except as such plans may be modified to conform to the Village codes and ordinances.
2. A plat of easement shall be provided by the developer to establish the proposed utility easements shown on the engineering drawings prepared by Toth & Associates dated December 9, 2025.

Staff Report Approved By:



Stanley J. Popovich, AICP
Director of Community Development

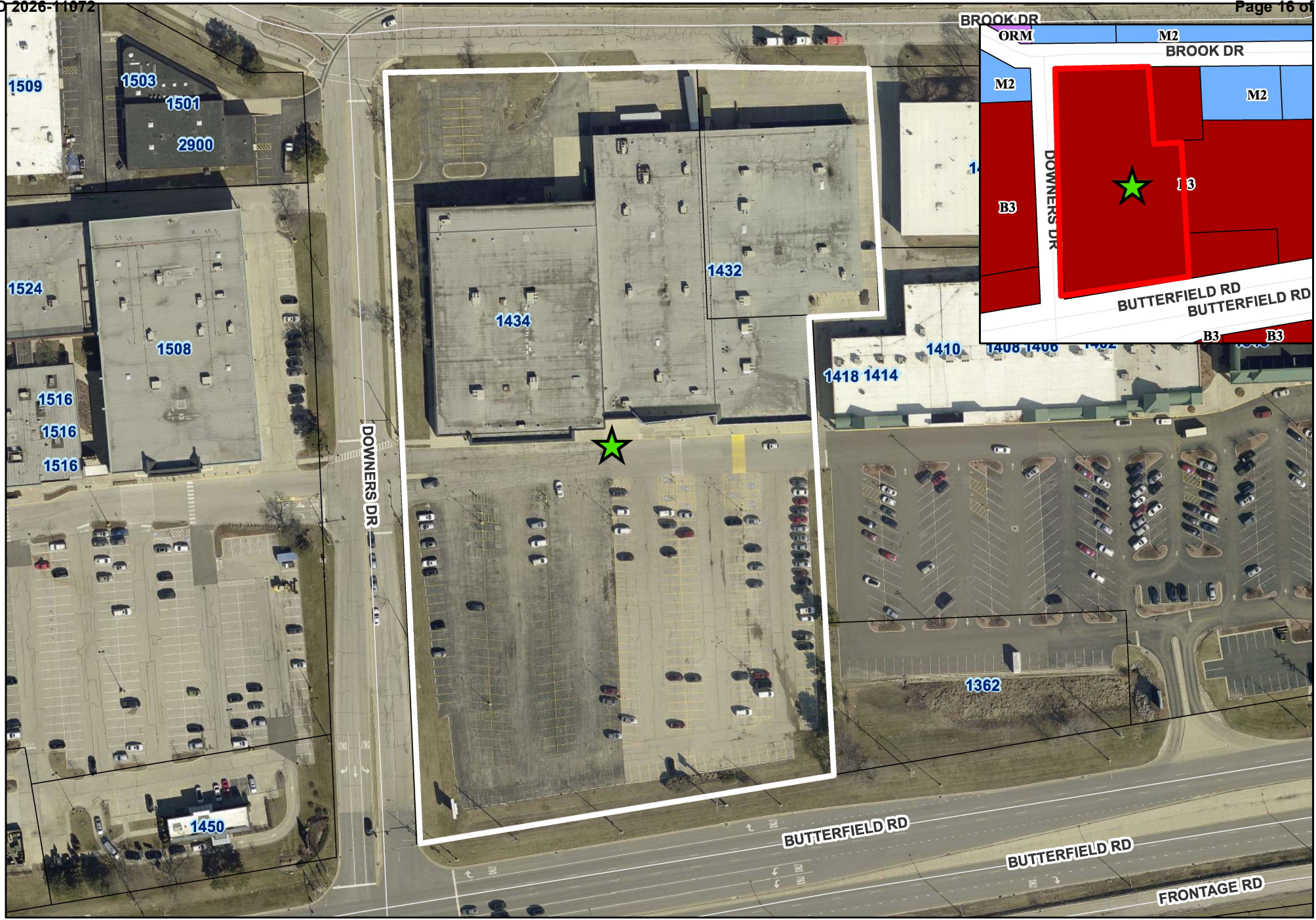

- SP; cm

P:\P&CD\PROJECTS\PLAN COMMISSION\2025 PZC Petition Files\25-PZC-0034 - 1434 Butterfield Rd - PUD, Special Use\25-PZC-0034_Staff Report.docx



0 62.5 125 Feet

1434 Butterfield Road Location Map

 Subject Property
 Site Location



Village of Downers Grove – Planning Department
Jason Zawila, Planning Manager
850 Curtiss Street
Downers Grove, IL 60515

RE: Request for Special Use Permit, Planned Use Development, and Zoning Map Amendment- Drive-Through Facility at 1434 Butterfield Road, Downers Grove, IL

Dear Mr. Zawila,

On behalf of Who Brew LLC, I am submitting this letter to formally request a **Special Use Permit, Planned Use Development (PUD), and Zoning Map Amendment** for the property located at 1434 Butterfield Road, in the Village of Downers Grove. The property is currently zoned B-3 General Services and Highway Business, and the proposed development includes a **drive-through facility**, which requires a **Special Use Permit** per the Village's Zoning Ordinance. Furthermore, the redevelopment of the outlot with two (2) buildings, converting it from existing parking stalls, will require a **PUD**. This PUD proposal seeks relief from the Village Code parking requirements. A Parking Analysis has been provided that shows the number of stalls before and after the proposed development. This PUD proposal seeks relief for the location of a trash enclosure in the street yard along Downers Drive. Because a PUD is requested, a **Zoning Map Amendment** is being requested as well.

7 Brew Drive-Through Coffee ("7 Brew"), founded in Rogers, AR in 2017 has 494 stands nationwide. Specializing in serving premium espresso-based coffee, chillers, teas, infused energy drinks, sodas and smoothies, there are over 20,000 unique drink options that can be created from 7 Brew's menu. 7 Brew is a drive-thru concept with a dual drive-thru configuration. Team members take orders on tablets instead of a traditional drive-thru speaker box, which allows 7 Brew to create personal relationships with their customers and serve them in a fast-paced and friendly environment. 7 Brew's focus to their customer is speed and a friendly, welcoming environment, which resonates amongst its team members and customers. The goal is to make the customers experience at 7 Brew the happiest part of their day, which drives business and keeps customers coming back. The concept opens at 5:30 AM and closes at 10:00 PM on weekdays and 11:00 PM on weekends. Each 7 Brew location operates with 5 employees at the stand during peak times. There are 750 orders a day which equates to ~1,125 estimated customers per day.

To assist in your review, we are providing the following materials:

- Application fee for **PUD** (\$2,205), **PUD Site Plan** (\$290), and **Special use** (\$1,290) = \$3,785.00.
- Completed petitions for **Special Use, PUD, and Zoning Map Amendment**



- Petitioner's Submittal Checklist: Planning & Zoning Commission
- Proof of Ownership
- Plat of Survey
- Civil plan package
- Traffic Memo
- Architectural package (including color renderings)
- Sign package
- Photometric Plan
- Downers Grove Sanitary District Review – Plans have been submitted for review and, once received, a conceptual approval letter will be provided to supplement this submittal.

We believe this project aligns with the Village's goals and would be a positive addition to the local business community. We appreciate the opportunity to work with the Village on this request.

Chris George
Who Brew LLC



Planned Unit Development

Form #PC01

Review and Approval Criteria

Address of Project Site: 1434 Butterfield Rd Downers Grove, IL 60515

A detailed response to all of the standards shall be provided, specifying how each standard is or is not met.

Section 28.12.040.C.6. Review and Approval Criteria (Planned Unit Development)

The decision to amend the zoning map to approve a PUD plan and to establish a PUD overlay district are matters of legislative discretion that are not controlled by any single standard. In making recommendations and decisions regarding approval of planned unit developments, review and decision making bodies must consider at least the following factors:

1. The zoning map amendment review and approval criteria of Sec. 12.030.I.
See the analysis of zoning map amendment review and approval criteria in separate document.

See attached document

2. Whether the proposed PUD plan and map amendment would be consistent with the Comprehensive Plan and any other adopted plans for the subject area.

See attached document

3. Whether PUD plan complies with the PUD overlay district provisions of Sec. 4.030.

See attached document

4. Whether the proposed development will result in public benefits that are greater than or at least equal to those that would have resulted from development under conventional zoning regulations.

See attached document

5. Whether appropriate terms and conditions have been imposed on the approval to protect the interests of surrounding property owners and residents, existing and future residents of the PUD and the general public.

See attached document



Planned Unit Development: Responses to Standards

1. An application responding to the approval criteria for a zoning map amendment has been included with this submittal.
2. Outlot development is promoted as a feature of the Village's Comprehensive Plan.
3. The proposed plan complies with the requirements of the PUD overlay district as outlined in Section 4.030. The PUD promotes flexibility in development that would not be possible under standard zoning (multiple structures on one lot) while meeting the goals of the Comprehensive Plan.
4. The proposed development will result in public benefits greater than development under conventional zoning regulations. The proposed use allows operation of an additional business on the same lot. This proposal seeks relief to Village Code parking requirements. According to VoDG 28.7.030, 3.5 spaces are required per 1,000 square feet of the shopping center. A Parking Analysis has been provided that shows the number of stalls before and after the proposed development. In addition, this proposal seeks relief for placement of the trash enclosure in the street yard along Downers Drive. It is infeasible to move this enclosure any further north.
5. Yes, appropriate terms and conditions have been imposed to ensure interests of surrounding property owners, existing and future residents of the PUD and the general public. These conditions address key concerns such as meeting all applicable building code requirements and providing appropriate traffic circulation.

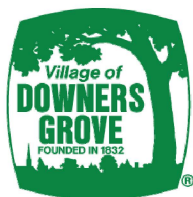

Special Uses

Review and Approval Criteria

Form #PZC2

Address of Project Site: 1434 Butterfield Rd Downers Grove, IL 60515

A detailed response to all of the standards shall be provided, specifying how each standard is or is not met.

Section 28.12.050.H. Approval Criteria (Special Uses)

No special use may be recommended for approval or approved unless the respective review or decision-making body determines that the proposed special use is consistent with and in substantial compliance with all Village Council policies and plans, including, but not limited to, the Comprehensive Plan and the Downtown Design Guidelines and that the applicant has presented evidence to support each of the following conclusions:

1. That the proposed use is expressly authorized as a Special Use in the district in which it is to be located.

The property is located in the B-3, General Services and Highway Business zoning district. A drive-through is an allowable special use within the B-3 zoning district.

2. That the proposed use will not, in the particular case, be detrimental to the health, safety, or general welfare of the community.

The proposed use will not be detrimental to the health, safety, or general welfare of the community. The layout promotes safe vehicular circulation, incorporates lighting, fire access, and security measures. The project will fully comply with all relevant city standards for new construction.

3. That the proposed use will not be injurious to the use and enjoyment of other property in the immediate area for the purposes already permitted, nor substantially diminish or impair property values within the neighborhood.

The proposed development will not be injurious to the enjoyment and use of other properties in the area. This project is activating an area of the shopping center which is currently being utilized for parking. The area is in the furthest location of the parking lot from commercial businesses, and historical imagery on Google Earth shows very little use of this space for parking. There appears to be an abundance of parking for commercial uses in the immediate area.

4. That the establishment of the special use will not impede the normal and orderly development and improvement of adjacent property for uses permitted in the district.

The establishment of the special use will not impede the normal and orderly development and improvement of adjacent properties for uses permitted in the district. The design will ensure safe traffic flow, appropriate access and buffering to minimize impacts to surrounding uses.

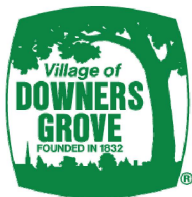

Zoning Map Amendments

Form #PC03

Review and Approval Criteria

Address of Project Site: 1434 Butterfield Rd Downers Grove, IL 60515

A detailed response to all of the standards shall be provided, specifying how each standard is or is not met.

Section 28.12.030.I. Review and Approval Criteria (Zoning Map Amendments - Rezoning)

The decision to amend the zoning map is a matter of legislative discretion that is not controlled by any single standard. In making recommendations and decisions about zoning map amendments, review and decision making bodies must consider at least the following factors:

1. The existing uses and zoning of nearby property.

See attached document

2. The extent to which the particular zoning restrictions affect property values.

See attached document

3. The extent to which any diminution in property value is offset by an increase in the public health, safety and welfare.

See attached document

4. The suitability of the subject property for the zoned purposes.

See attached document

5. The length of time that the subject property has been vacant as zoned, considering the context of land development in the vicinity.

See attached document

6. The value to the community of the proposed use.

See attached document

7. The Comprehensive Plan.

See attached document



Zoning Map Amendment: Responses to Standards

1. The property is located in the B-3, General Services and Highway Business zoning district. Surrounding properties are also zoned B3 and are utilized for retail establishments and restaurants.
2. The current restrictions would prevent the use of the lot for the proposed 7 Brew Drive-Through, diminishing its potential for redevelopment and impacts to property values.
3. The proposed variation will not impair air, increase fire risk, endanger public safety, or diminish property values. Additionally, it will not negatively impact traffic flows as there is appropriate queuing provided based on similar projects in neighboring communities.
4. The property is located in the B-3, General Services and Highway Business zoning district. A drive-through is an allowable special use within the B-3 zoning district.
5. Historic imagery on Google Earth show that this area has been used as an underutilized parking lot as far back as 1993.
6. The proposed drive-through coffee shop will offer a complementary service to the retail in this area. It will also provide a source of sales tax and highly sought-after entry level jobs within the community.
7. Outlot development is promoted as a feature of the Village's Comprehensive Plan. It is not possible to develop the outlot for the proposed business without development of a PUD and Zoning Map Amendment.

ALTA / NSPS LAND TITLE SURVEY
LOT 1 AND PART OF LOT 2 IN OAK GROVE CENTRE
OF COMMERCE UNIT ONE,
A PART OF THE EAST HALF OF
SECTION 30 T38N, R11E OF THE THIRD P.M.
DUPAGE COUNTY, ILLINOIS.

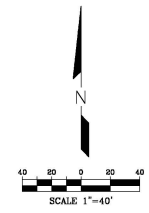

- LEGEND:**
- A YARD LIGHT
 - B LIGHT POLE
 - C SPWAL POLE
 - D UTILITY POLE
 - E GUY WIRE
 - F CONDUIT
 - G CONDUIT RIG
 - H ELECTRIC WIRE
 - I WIRE
 - J PHONE WIRE
 - K SATELLITE DISH
 - L SIGNAL MOUNT
 - M STEEL METER
 - N STEEL METER
 - O WATER METER
 - P GAS METER
 - Q GAS METER
 - R GAS METER
 - S GAS METER
 - T GAS METER
 - U GAS METER
 - V GAS METER
 - W GAS METER
 - X GAS METER
 - Y GAS METER
 - Z GAS METER
 - AA GAS METER
 - AB GAS METER
 - AC GAS METER
 - AD GAS METER
 - AE GAS METER
 - AF GAS METER
 - AG GAS METER
 - AH GAS METER
 - AI GAS METER
 - AJ GAS METER
 - AK GAS METER
 - AL GAS METER
 - AM GAS METER
 - AN GAS METER
 - AO GAS METER
 - AP GAS METER
 - AQ GAS METER
 - AR GAS METER
 - AS GAS METER
 - AT GAS METER
 - AU GAS METER
 - AV GAS METER
 - AW GAS METER
 - AX GAS METER
 - AY GAS METER
 - AZ GAS METER
 - BA GAS METER
 - BB GAS METER
 - BC GAS METER
 - BD GAS METER
 - BE GAS METER
 - BF GAS METER
 - BG GAS METER
 - BH GAS METER
 - BI GAS METER
 - BJ GAS METER
 - BK GAS METER
 - BL GAS METER
 - BM GAS METER
 - BN GAS METER
 - BO GAS METER
 - BP GAS METER
 - BQ GAS METER
 - BR GAS METER
 - BS GAS METER
 - BT GAS METER
 - BU GAS METER
 - BV GAS METER
 - BW GAS METER
 - BX GAS METER
 - BY GAS METER
 - BZ GAS METER
 - CA GAS METER
 - CB GAS METER
 - CC GAS METER
 - CD GAS METER
 - CE GAS METER
 - CF GAS METER
 - CG GAS METER
 - CH GAS METER
 - CI GAS METER
 - CJ GAS METER
 - CK GAS METER
 - CL GAS METER
 - CM GAS METER
 - CN GAS METER
 - CO GAS METER
 - CP GAS METER
 - CQ GAS METER
 - CR GAS METER
 - CS GAS METER
 - CT GAS METER
 - CU GAS METER
 - CV GAS METER
 - CW GAS METER
 - CX GAS METER
 - CY GAS METER
 - CZ GAS METER
 - DA GAS METER
 - DB GAS METER
 - DC GAS METER
 - DD GAS METER
 - DE GAS METER
 - DF GAS METER
 - DG GAS METER
 - DH GAS METER
 - DI GAS METER
 - DJ GAS METER
 - DK GAS METER
 - DL GAS METER
 - DM GAS METER
 - DN GAS METER
 - DO GAS METER
 - DP GAS METER
 - DQ GAS METER
 - DR GAS METER
 - DS GAS METER
 - DT GAS METER
 - DU GAS METER
 - DV GAS METER
 - DW GAS METER
 - DX GAS METER
 - DY GAS METER
 - DZ GAS METER
 - EA GAS METER
 - EB GAS METER
 - EC GAS METER
 - ED GAS METER
 - EE GAS METER
 - EF GAS METER
 - EG GAS METER
 - EH GAS METER
 - EI GAS METER
 - EJ GAS METER
 - EK GAS METER
 - EL GAS METER
 - EM GAS METER
 - EN GAS METER
 - EO GAS METER
 - EP GAS METER
 - EQ GAS METER
 - ER GAS METER
 - ES GAS METER
 - ET GAS METER
 - EU GAS METER
 - EV GAS METER
 - EW GAS METER
 - EX GAS METER
 - EY GAS METER
 - EZ GAS METER
 - FA GAS METER
 - FB GAS METER
 - FC GAS METER
 - FD GAS METER
 - FE GAS METER
 - FF GAS METER
 - FG GAS METER
 - FH GAS METER
 - FI GAS METER
 - FJ GAS METER
 - FK GAS METER
 - FL GAS METER
 - FM GAS METER
 - FN GAS METER
 - FO GAS METER
 - FP GAS METER
 - FQ GAS METER
 - FR GAS METER
 - FS GAS METER
 - FT GAS METER
 - FU GAS METER
 - FV GAS METER
 - FW GAS METER
 - FX GAS METER
 - FY GAS METER
 - FZ GAS METER
 - GA GAS METER
 - GB GAS METER
 - GC GAS METER
 - GD GAS METER
 - GE GAS METER
 - GF GAS METER
 - GG GAS METER
 - GH GAS METER
 - GI GAS METER
 - GJ GAS METER
 - GK GAS METER
 - GL GAS METER
 - GM GAS METER
 - GN GAS METER
 - GO GAS METER
 - GP GAS METER
 - GQ GAS METER
 - GR GAS METER
 - GS GAS METER
 - GT GAS METER
 - GU GAS METER
 - GV GAS METER
 - GW GAS METER
 - GX GAS METER
 - GY GAS METER
 - GAZ GAS METER
 - HA GAS METER
 - HB GAS METER
 - HC GAS METER
 - HD GAS METER
 - HE GAS METER
 - HF GAS METER
 - HG GAS METER
 - HH GAS METER
 - HI GAS METER
 - HJ GAS METER
 - HK GAS METER
 - HL GAS METER
 - HM GAS METER
 - HN GAS METER
 - HO GAS METER
 - HP GAS METER
 - HQ GAS METER
 - HR GAS METER
 - HS GAS METER
 - HT GAS METER
 - HU GAS METER
 - HV GAS METER
 - HW GAS METER
 - HX GAS METER
 - HY GAS METER
 - HZ GAS METER
 - IA GAS METER
 - IB GAS METER
 - IC GAS METER
 - ID GAS METER
 - IE GAS METER
 - IF GAS METER
 - IG GAS METER
 - IH GAS METER
 - II GAS METER
 - IJ GAS METER
 - IK GAS METER
 - IL GAS METER
 - IM GAS METER
 - IN GAS METER
 - IO GAS METER
 - IP GAS METER
 - IQ GAS METER
 - IR GAS METER
 - IS GAS METER
 - IT GAS METER
 - IU GAS METER
 - IV GAS METER
 - IW GAS METER
 - IX GAS METER
 - IY GAS METER
 - IZ GAS METER
 - JA GAS METER
 - JB GAS METER
 - JC GAS METER
 - JD GAS METER
 - JE GAS METER
 - JF GAS METER
 - JG GAS METER
 - JH GAS METER
 - JI GAS METER
 - JK GAS METER
 - JL GAS METER
 - JM GAS METER
 - JN GAS METER
 - JO GAS METER
 - JP GAS METER
 - JQ GAS METER
 - JR GAS METER
 - JS GAS METER
 - JT GAS METER
 - JU GAS METER
 - JV GAS METER
 - JW GAS METER
 - JX GAS METER
 - JY GAS METER
 - JZ GAS METER
 - KA GAS METER
 - KB GAS METER
 - KC GAS METER
 - KD GAS METER
 - KE GAS METER
 - KF GAS METER
 - KG GAS METER
 - KH GAS METER
 - KI GAS METER
 - KJ GAS METER
 - KK GAS METER
 - KL GAS METER
 - KM GAS METER
 - KN GAS METER
 - KO GAS METER
 - KP GAS METER
 - KQ GAS METER
 - KR GAS METER
 - KS GAS METER
 - KT GAS METER
 - KU GAS METER
 - KV GAS METER
 - KW GAS METER
 - KX GAS METER
 - KY GAS METER
 - KZ GAS METER
 - LA GAS METER
 - LB GAS METER
 - LC GAS METER
 - LD GAS METER
 - LE GAS METER
 - LF GAS METER
 - LG GAS METER
 - LH GAS METER
 - LI GAS METER
 - LJ GAS METER
 - LK GAS METER
 - LL GAS METER
 - LM GAS METER
 - LN GAS METER
 - LO GAS METER
 - LP GAS METER
 - LQ GAS METER
 - LR GAS METER
 - LS GAS METER
 - LT GAS METER
 - LU GAS METER
 - LV GAS METER
 - LW GAS METER
 - LX GAS METER
 - LY GAS METER
 - LZ GAS METER
 - MA GAS METER
 - MB GAS METER
 - MC GAS METER
 - MD GAS METER
 - ME GAS METER
 - MF GAS METER
 - MG GAS METER
 - MH GAS METER
 - MI GAS METER
 - MJ GAS METER
 - MK GAS METER
 - ML GAS METER
 - MM GAS METER
 - MN GAS METER
 - MO GAS METER
 - MP GAS METER
 - MQ GAS METER
 - MR GAS METER
 - MS GAS METER
 - MT GAS METER
 - MU GAS METER
 - MV GAS METER
 - MW GAS METER
 - MX GAS METER
 - MY GAS METER
 - MZ GAS METER
 - NA GAS METER
 - NB GAS METER
 - NC GAS METER
 - ND GAS METER
 - NE GAS METER
 - NF GAS METER
 - NG GAS METER
 - NH GAS METER
 - NI GAS METER
 - NJ GAS METER
 - NK GAS METER
 - NL GAS METER
 - NM GAS METER
 - NO GAS METER
 - NP GAS METER
 - NQ GAS METER
 - NR GAS METER
 - NS GAS METER
 - NT GAS METER
 - NU GAS METER
 - NV GAS METER
 - NW GAS METER
 - NX GAS METER
 - NY GAS METER
 - NZ GAS METER
 - OA GAS METER
 - OB GAS METER
 - OC GAS METER
 - OD GAS METER
 - OE GAS METER
 - OF GAS METER
 - OG GAS METER
 - OH GAS METER
 - OI GAS METER
 - OJ GAS METER
 - OK GAS METER
 - OL GAS METER
 - OM GAS METER
 - ON GAS METER
 - OO GAS METER
 - OP GAS METER
 - OQ GAS METER
 - OR GAS METER
 - OS GAS METER
 - OT GAS METER
 - OU GAS METER
 - OV GAS METER
 - OW GAS METER
 - OX GAS METER
 - OY GAS METER
 - OZ GAS METER
 - PA GAS METER
 - PB GAS METER
 - PC GAS METER
 - PD GAS METER
 - PE GAS METER
 - PF GAS METER
 - PG GAS METER
 - PH GAS METER
 - PI GAS METER
 - PJ GAS METER
 - PK GAS METER
 - PL GAS METER
 - PM GAS METER
 - PN GAS METER
 - PO GAS METER
 - PP GAS METER
 - PQ GAS METER
 - PR GAS METER
 - PS GAS METER
 - PT GAS METER
 - PU GAS METER
 - PV GAS METER
 - PW GAS METER
 - PX GAS METER
 - PY GAS METER
 - PZ GAS METER
 - QA GAS METER
 - QB GAS METER
 - QC GAS METER
 - QD GAS METER
 - QE GAS METER
 - QF GAS METER
 - QG GAS METER
 - QH GAS METER
 - QI GAS METER
 - QJ GAS METER
 - QK GAS METER
 - QL GAS METER
 - QM GAS METER
 - QN GAS METER
 - QO GAS METER
 - QP GAS METER
 - QQ GAS METER
 - QR GAS METER
 - QS GAS METER
 - QT GAS METER
 - QU GAS METER
 - QV GAS METER
 - QW GAS METER
 - QX GAS METER
 - QY GAS METER
 - QZ GAS METER
 - RA GAS METER
 - RB GAS METER
 - RC GAS METER
 - RD GAS METER
 - RE GAS METER
 - RF GAS METER
 - RG GAS METER
 - RH GAS METER
 - RI GAS METER
 - RJ GAS METER
 - RK GAS METER
 - RL GAS METER
 - RM GAS METER
 - RO GAS METER
 - RP GAS METER
 - RQ GAS METER
 - RR GAS METER
 - RS GAS METER
 - RT GAS METER
 - RU GAS METER
 - RV GAS METER
 - RW GAS METER
 - RX GAS METER
 - RY GAS METER
 - RZ GAS METER
 - SA GAS METER
 - SB GAS METER
 - SC GAS METER
 - SD GAS METER
 - SE GAS METER
 - SF GAS METER
 - SG GAS METER
 - SH GAS METER
 - SI GAS METER
 - SJ GAS METER
 - SK GAS METER
 - SL GAS METER
 - SM GAS METER
 - SN GAS METER
 - SO GAS METER
 - SP GAS METER
 - SQ GAS METER
 - SR GAS METER
 - SS GAS METER
 - ST GAS METER
 - SU GAS METER
 - SV GAS METER
 - SW GAS METER
 - SX GAS METER
 - SY GAS METER
 - SZ GAS METER
 - TA GAS METER
 - TB GAS METER
 - TC GAS METER
 - TD GAS METER
 - TE GAS METER
 - TF GAS METER
 - TG GAS METER
 - TH GAS METER
 - TI GAS METER
 - TJ GAS METER
 - TK GAS METER
 - TL GAS METER
 - TM GAS METER
 - TO GAS METER
 - TP GAS METER
 - TQ GAS METER
 - TR GAS METER
 - TS GAS METER
 - TT GAS METER
 - TU GAS METER
 - TV GAS METER
 - TW GAS METER
 - TX GAS METER
 - TY GAS METER
 - TZ GAS METER
 - UA GAS METER
 - UB GAS METER
 - UC GAS METER
 - UD GAS METER
 - UE GAS METER
 - UF GAS METER
 - UG GAS METER
 - UH GAS METER
 - UI GAS METER
 - UJ GAS METER
 - UK GAS METER
 - UL GAS METER
 - UM GAS METER
 - UN GAS METER
 - UO GAS METER
 - UP GAS METER
 - UQ GAS METER
 - UR GAS METER
 - US GAS METER
 - UT GAS METER
 - UU GAS METER
 - UV GAS METER
 - UW GAS METER
 - UX GAS METER
 - UY GAS METER
 - UZ GAS METER
 - VA GAS METER
 - VB GAS METER
 - VC GAS METER
 - VD GAS METER
 - VE GAS METER
 - VF GAS METER
 - VG GAS METER
 - VH GAS METER
 - VI GAS METER
 - VJ GAS METER
 - VK GAS METER
 - VL GAS METER
 - VM GAS METER
 - VO GAS METER
 - VP GAS METER
 - VQ GAS METER
 - VR GAS METER
 - VS GAS METER
 - VT GAS METER
 - VU GAS METER
 - VV GAS METER
 - VW GAS METER
 - VX GAS METER
 - VY GAS METER
 - VZ GAS METER
 - WA GAS METER
 - WB GAS METER
 - WC GAS METER
 - WD GAS METER
 - WE GAS METER
 - WF GAS METER
 - WG GAS METER
 - WH GAS METER
 - WI GAS METER
 - WJ GAS METER
 - WK GAS METER
 - WL GAS METER
 - WM GAS METER
 - WO GAS METER
 - WP GAS METER
 - WQ GAS METER
 - WR GAS METER
 - WS GAS METER
 - WT GAS METER
 - WU GAS METER
 - WV GAS METER
 - WW GAS METER
 - WX GAS METER
 - WY GAS METER
 - WZ GAS METER
 - XA GAS METER
 - XB GAS METER
 - XC GAS METER
 - XD GAS METER
 - XE GAS METER
 - XF GAS METER
 - XG GAS METER
 - XH GAS METER
 - XI GAS METER
 - XJ GAS METER
 - XK GAS METER
 - XL GAS METER
 - XM GAS METER
 - XN GAS METER
 - XO GAS METER
 - XP GAS METER
 - XQ GAS METER
 - XR GAS METER
 - XS GAS METER
 - XT GAS METER
 - XU GAS METER
 - XV GAS METER
 - XW GAS METER
 - XX GAS METER
 - XY GAS METER
 - XZ GAS METER
 - YA GAS METER
 - YB GAS METER
 - YC GAS METER
 - YD GAS METER
 - YE GAS METER
 - YF GAS METER
 - YG GAS METER
 - YH GAS METER
 - YI GAS METER
 - YJ GAS METER
 - YK GAS METER
 - YL GAS METER
 - YM GAS METER
 - YN GAS METER
 - YO GAS METER
 - YP GAS METER
 - YQ GAS METER
 - YR GAS METER
 - YS GAS METER
 - YT GAS METER
 - YU GAS METER
 - YV GAS METER
 - YW GAS METER
 - YX GAS METER
 - YY GAS METER
 - YZ GAS METER
 - ZA GAS METER
 - ZB GAS METER
 - ZC GAS METER
 - ZD GAS METER
 - ZE GAS METER
 - ZF GAS METER
 - ZG GAS METER
 - ZH GAS METER
 - ZI GAS METER
 - ZJ GAS METER
 - ZK GAS METER
 - ZL GAS METER
 - ZM GAS METER
 - ZN GAS METER
 - ZO GAS METER
 - ZP GAS METER
 - ZQ GAS METER
 - ZR GAS METER
 - ZS GAS METER
 - ZT GAS METER
 - ZU GAS METER
 - ZV GAS METER
 - ZW GAS METER
 - ZX GAS METER
 - ZY GAS METER
 - ZZ GAS METER

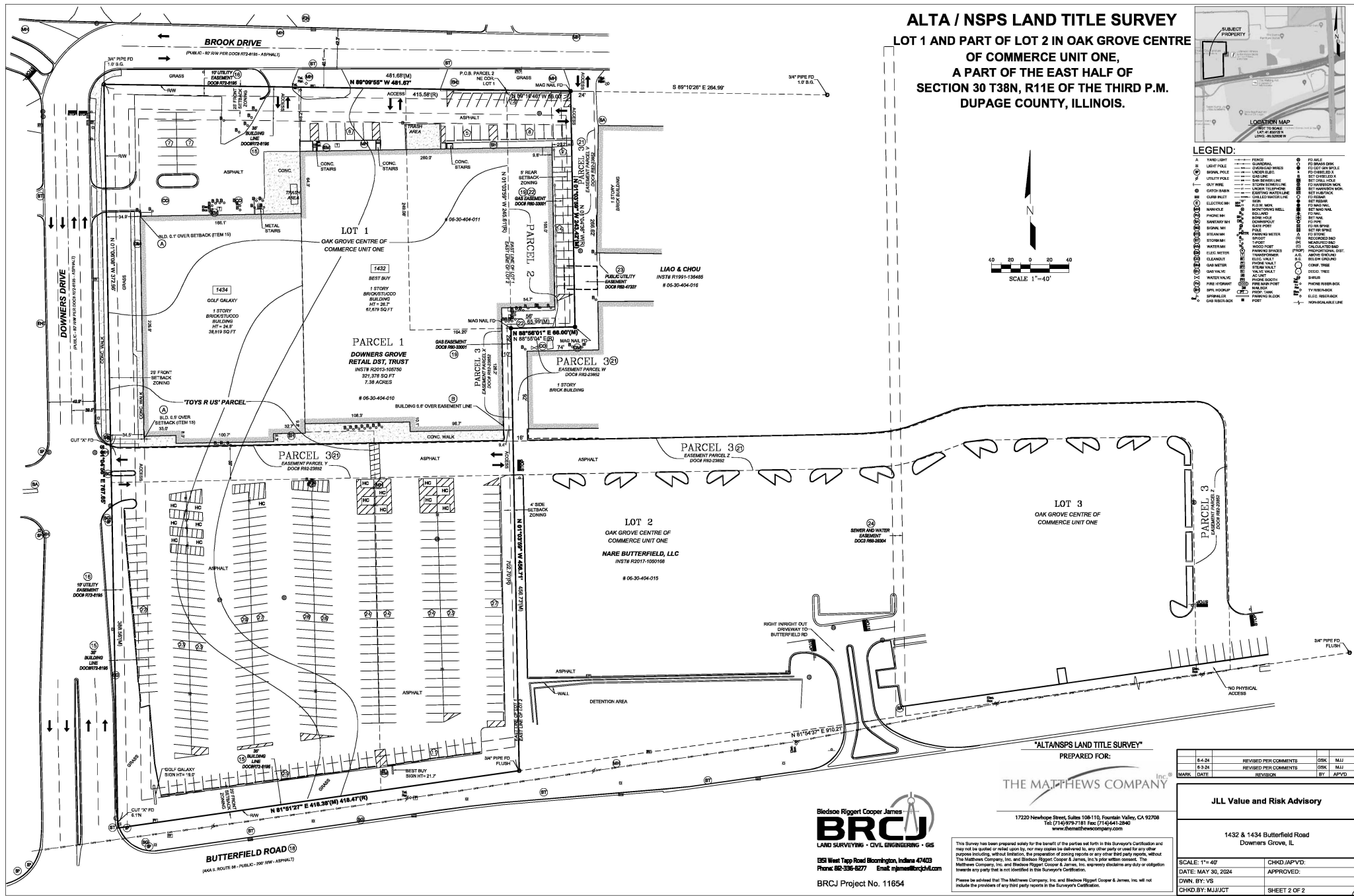

Bledsoe Riggert Cooper James
BRCJ
 LAND SURVEYING • CIVIL ENGINEERING • GIS
 651 West Tapp Road Bloomington, Indiana 47403
 Phone: 812-336-8277 Email: njm@brcjvl.com
 BRCJ Project No. 11654

"ALTA/NSPS LAND TITLE SURVEY"
 PREPARED FOR:
 THE MATTHEWS COMPANY, Inc.
 17220 Newhope Street, Suite 108-110, Fountain Valley, CA 92708
 Tel: (714) 979-7181 Fax: (714) 941-0240
 www.benmatthewscompany.com

6.4.24	REVISED PER COMMENTS	CRK	MLJ
6.5.24	REVISED PER COMMENTS	CRK	MLJ
MARK	DATE	REVISION	BY / APVD

JLL Value and Risk Advisory
 1432 & 1434 Butterfield Road
 Downers Grove, IL
 SCALE: 1"=40'
 DATE: MAY 30, 2024
 DWN BY: VS
 CHKD BY: MJ/JCT

CHKD/APVD:
 APPROVED:
 SHEET 2 OF 2

J.N.: 24-05-01-06002

This Survey has been prepared solely for the benefit of the parties set forth in this Surveyor's Certification and may not be quoted or used in any way, nor may copies be delivered to any other party or used for any other purpose including, without limitation, the preparation of zoning records or any other third party records, without the Matthews Company, Inc. and Bledsoe Riggert Cooper & James, Inc.'s prior written consent. The Matthews Company, Inc. and Bledsoe Riggert Cooper & James, Inc. expressly disclaims any duty or obligation towards any party that is not identified in this Surveyor's Certification.
 Please be advised that The Matthews Company, Inc. and Bledsoe Riggert Cooper & James, Inc. will not include the provisions of any third party reports in the Surveyor's Certification.

ALTA / NSPS LAND TITLE SURVEY
LOT 1 AND PART OF LOT 2 IN OAK GROVE CENTRE OF COMMERCE UNIT ONE,
A PART OF THE EAST HALF OF
SECTION 30 T38N, R11E OF THE THIRD P.M.
DUPAGE COUNTY, ILLINOIS.

DESCRIPTION

PARCEL 1:
LOT 1 IN OAK GROVE CENTRE OF COMMERCE UNIT ONE, BEING A SUBDIVISION OF PART OF THE EAST 1/2 OF SECTION 30, TOWNSHIP 39 NORTH, RANGE 11, EAST OF THE THIRD PRINCIPAL MERIDIAN, ACCORDING TO THE PLAT THEREOF RECORDED FEBRUARY 7, 1972 AS DOCUMENT NO. R72-6195, IN DUPAGE COUNTY, ILLINOIS.

PARCEL 2:
THAT PART OF LOT 2 DESCRIBED AS BEGINNING AT THE NORTHWEST CORNER OF SAID LOT 2; THENCE SOUTH 01 DEGREE 04 MINUTES 56 SECONDS EAST ALONG THE WESTERLY LINE OF SAID LOT 2 A DISTANCE OF 245.61 FEET TO A POINT; THENCE NORTH 88 DEGREES 55 MINUTES 56 SECONDS EAST ALONG A LINE PERPENDICULAR TO THE WESTERLY LINE OF SAID LOT 2 A DISTANCE OF 86 FEET TO A POINT; THENCE NORTH 01 DEGREE 04 MINUTES 56 SECONDS WEST ON A LINE PARALLEL TO THE WEST LINE OF LOT 2, A DISTANCE OF 243.42 FEET TO THE NORTH LINE OF SAID LOT 2; THENCE NORTH 88 DEGREES 10 MINUTES 46 SECONDS WEST ALONG THE NORTH LINE OF SAID LOT 2, A DISTANCE OF 86.04 FEET TO THE POINT OF BEGINNING, ALL IN OAK GROVE CENTRE OF COMMERCE, UNIT 1 BEING A SUBDIVISION OF PART OF THE EAST 1/2 OF SECTION 30, TOWNSHIP 39 NORTH, RANGE 11, EAST OF THE THIRD PRINCIPAL MERIDIAN, ACCORDING TO THE PLAT THEREOF RECORDED FEBRUARY 7, 1972 AS DOCUMENT NO. R72-6195, IN DUPAGE COUNTY, ILLINOIS.

PARCEL 3
PERPETUAL, NON-EXCLUSIVE EASEMENTS FOR THE BENEFIT OF PARCELS 1 AND 2 AS CREATED BY CONSTRUCTION, OPERATION, MAINTENANCE AND RECIPROCAL EASEMENT AGREEMENT BY AND BETWEEN NATIONAL BOULEVARD BANK OF CHICAGO, AS TRUSTEE UNDER TRUST AGREEMENT DATED FEBRUARY 22, 1970 AND KNOWN AS TRUST NUMBER 3932, DROWERS BANK OF CHICAGO, AS TRUSTEE UNDER TRUST AGREEMENT DATED JANUARY 22, 1980 KNOWN AS TRUST NUMBER 80012 AND NATIONAL BOULEVARD BANK OF CHICAGO, AS TRUSTEE UNDER TRUST AGREEMENT DATED MARCH 24, 1978 KNOWN AS TRUST NUMBER 5904, AND DATED NOVEMBER 27, 1982 AND RECORDED JUNE 10, 1982 AS DOCUMENT NO. R82-28652 FOR THE PEDESTRIAN AND VEHICULAR TRAFFIC OVER THE FOLLOWING DESCRIBED FIVE (5) EASEMENTS:

EASEMENT PARCEL "A":
THE NORTHERLY 180 FEET OF THE FOLLOWING DESCRIBED PARCEL:
THAT PART OF LOT 2 IN OAK GROVE CENTRE OF COMMERCE, UNIT 1, DESCRIBED AS FOLLOWS:
COMMENCING AT THE NORTHWEST CORNER OF SAID LOT 2; THENCE SOUTH 01 DEGREE 04 MINUTES 56 SECONDS EAST, ALONG THE WEST LINE OF SAID LOT, A DISTANCE OF 245.61 FEET TO THE POINT OF BEGINNING; THENCE CONTINUING SOUTH 01 DEGREE 04 MINUTES 56 SECONDS EAST ALONG SAID WEST LINE A DISTANCE OF 116.0 FEET; THENCE NORTH 88 DEGREES 55 MINUTES 04 SECONDS EAST, A DISTANCE OF 19 FEET; THENCE NORTH 01 DEGREE 04 MINUTES 56 SECONDS WEST, A DISTANCE OF 92.0 FEET; THENCE NORTH 88 DEGREES 55 MINUTES 04 SECONDS EAST, A DISTANCE OF 74 FEET; THENCE NORTH 01 DEGREE 04 MINUTES 56 SECONDS WEST, A DISTANCE OF 206.82 FEET TO A POINT ON THE NORTHERLY LINE OF SAID LOT 2; THENCE NORTH 88 DEGREES 10 MINUTES 46 SECONDS WEST ALONG THE NORTHERLY LINE OF SAID LOT 2, A DISTANCE OF 30.01 FEET; THENCE SOUTH 01 DEGREE 04 MINUTES 56 SECONDS EAST A DISTANCE OF 243.42 FEET; THENCE SOUTH 88 DEGREES 55 MINUTES 04 SECONDS WEST A DISTANCE OF 86 FEET TO THE POINT OF BEGINNING, ALL IN OAK GROVE CENTRE OF COMMERCE, UNIT 1, BEING A SUBDIVISION OF PART OF THE EAST 1/2 OF SECTION 30, TOWNSHIP 39 NORTH, RANGE 11, EAST OF THE THIRD PRINCIPAL MERIDIAN, IN DUPAGE COUNTY, ILLINOIS.

EASEMENT PARCEL "B":
THE FOLLOWING DESCRIBED PARCEL, EXCEPT THE NORTH 180 FEET THEREOF:
THAT PART OF LOT 2 IN OAK GROVE CENTRE OF COMMERCE, UNIT 1, DESCRIBED AS FOLLOWS:
COMMENCING AT THE NORTHWEST CORNER OF SAID LOT 2; THENCE SOUTH 1 DEGREE 04 MINUTES 56 SECONDS EAST ALONG THE WEST LINE OF SAID LOT, A DISTANCE OF 245.61 FEET TO THE POINT OF BEGINNING; THENCE CONTINUING SOUTH 1 DEGREE 04 MINUTES 56 SECONDS EAST ALONG SAID WEST LINE A DISTANCE OF 116.0 FEET; THENCE NORTH 88 DEGREES 55 MINUTES 04 SECONDS EAST, A DISTANCE OF 19 FEET; THENCE NORTH 1 DEGREE 04 MINUTES 56 SECONDS WEST, A DISTANCE OF 92.0 FEET; THENCE NORTH 88 DEGREES 55 MINUTES 04 SECONDS EAST, A DISTANCE OF 74 FEET; THENCE NORTH 1 DEGREE 04 MINUTES 56 SECONDS WEST, A DISTANCE OF 206.82 FEET TO A POINT ON THE NORTHERLY LINE OF SAID LOT 2; THENCE NORTH 88 DEGREES 10 MINUTES 46 SECONDS WEST ALONG THE NORTHERLY LINE OF SAID LOT 2, A DISTANCE OF 30.01 FEET; THENCE SOUTH 1 DEGREE 04 MINUTES 56 SECONDS EAST A DISTANCE OF 243.42 FEET; THENCE SOUTH 88 DEGREES 55 MINUTES 04 SECONDS WEST A DISTANCE OF 86 FEET TO THE POINT OF BEGINNING, ALL IN OAK GROVE CENTRE OF COMMERCE, UNIT 1, BEING A SUBDIVISION OF PART OF THE EAST 1/2 OF SECTION 30, TOWNSHIP 39 NORTH, RANGE 11, EAST OF THE THIRD PRINCIPAL MERIDIAN, IN DUPAGE COUNTY, ILLINOIS.

EASEMENT PARCEL "C":
INTENTIONALLY DELETED.

EASEMENT PARCEL "D":
INTENTIONALLY DELETED.

EASEMENT PARCEL "E":
THAT PART OF LOTS 2 AND 3 IN OAK GROVE CENTRE OF COMMERCE, UNIT 1, DESCRIBED AS FOLLOWS:
COMMENCING AT THE NORTHWEST CORNER OF LOT 2; THENCE SOUTH 1 DEGREE 04 MINUTES 56 SECONDS EAST ALONG THE WEST LINE OF SAID LOT 2, 351.61 FEET TO THE POINT OF BEGINNING; THENCE NORTH 88 DEGREES 55 MINUTES 04 SECONDS EAST, 359.78 FEET TO THE POINT OF CURVE; THENCE 89.77 FEET EASTERLY ALONG A CURVE CONCAVE NORTHERLY, HAVING A RADIUS OF 178.01 FEET (CHORD BEARING NORTH 77 DEGREES 41 MINUTES 20 SECONDS EAST AND A DISTANCE OF 89.33 FEET) TO POINT OF REVERSE CURVE; THENCE EASTERLY 80.77 FEET ALONG A CURVE CONCAVE SOUTHERLY, HAVING A RADIUS OF 178.01 FEET (CHORD BEARING NORTH 77 DEGREES 41 MINUTES 20 SECONDS EAST AND A DISTANCE OF 89.33 FEET) TO POINT OF TANGENT; THENCE NORTH 88 DEGREES 55 MINUTES 04 SECONDS EAST, 207.75 FEET TO POINT OF CURVE; THENCE SOUTHERLY 51.25 FEET ALONG A CURVE CONCAVE SOUTHWESTERLY, HAVING A RADIUS OF 30 FEET (CHORD BEARING SOUTH 46 DEGREES 04 MINUTES 56 SECONDS EAST AND A DISTANCE OF 42.43 FEET) TO POINT OF TANGENT, SAID POINT BEING ON A LINE 170 FEET WEST OF AND PARALLEL TO THE EAST LINE OF LOT 1; THENCE SOUTH 1 DEGREE 04 MINUTES 56 SECONDS EAST ALONG THE FOREBREAD PARALLEL LINE 180 FEET TO A POINT ON THE SOUTHERLY LINE OF LOT 3; THENCE SOUTH 81 DEGREES 54 MINUTES 34 SECONDS WEST ALONG THE SOUTHERLY LINE OF LOT 3, 35.26 FEET; THENCE NORTH 1 DEGREE 04 MINUTES 56 SECONDS WEST, 227.21 FEET TO POINT OF CURVE; THENCE NORTHERLY 31.42 FEET ALONG A CURVE CONCAVE SOUTHWESTERLY, HAVING A RADIUS OF 30 FEET (CHORD BEARING NORTH 46 DEGREES 04 MINUTES 56 SECONDS WEST AND A DISTANCE OF 28.26 FEET), TO POINT OF TANGENT; THENCE SOUTH 88 DEGREES 55 MINUTES 04 SECONDS WEST, 182.75 FEET TO POINT OF CURVE; THENCE WESTERLY 56.06 FEET ALONG A CURVE CONVEX NORTHERLY, HAVING A RADIUS OF 143.01 FEET (CHORD BEARING SOUTH 77 DEGREES 41 MINUTES 20 SECONDS WEST AND A DISTANCE OF 56.79 FEET) TO POINT OF REVERSE CURVE; THENCE WESTERLY 83.49 FEET ALONG A CURVE CONVEX SOUTHERLY, HAVING A RADIUS OF 213.01 FEET (CHORD BEARING SOUTH 77 DEGREES 41 MINUTES 20 SECONDS WEST AND A DISTANCE OF 82.98 FEET) TO POINT OF TANGENT; THENCE SOUTH 88 DEGREES 55 MINUTES 04 SECONDS WEST, 338.38 FEET TO A POINT ON THE WEST LINE OF LOT 2; THENCE NORTH 1 DEGREE 04 MINUTES 56 SECONDS WEST ALONG THE WEST LINE OF LOT 2, 35 FEET TO THE POINT OF BEGINNING, ALL IN OAK GROVE CENTRE OF COMMERCE, UNIT 1, BEING A SUBDIVISION OF PART OF THE EAST 1/2 OF SECTION 30, TOWNSHIP 39 NORTH, RANGE 11, EAST OF THE THIRD PRINCIPAL MERIDIAN, IN DUPAGE COUNTY, ILLINOIS.

CERTIFICATION

To: First24 Downers Grove LLC, Alpha Income Property OP, LP, Alpha Income Property GP, LLC, Alpha Income Property Trust, Inc., JLL Value and Risk Advisory, LLC, Chicago Title Insurance Company, The Matthews Company, Inc.

This is to certify that this map or plat and the survey on which it is based were made in accordance with the 2021 Minimum Standard Detail Requirements for ALTA/NSPS Land Title Surveys, jointly established and adopted by ALTA and NSPS, and includes Items 1, 2, 3, 4, 6a, 6b, 7a, 7b1, 7c, 8, 9, 10, 13, 14, 16, 17, 18 and 19 of Table A thereof. The field work for this survey was performed on May 16, 2024.

Date of Plat or Map: May 30, 2024

By: James C. Tibbett
Professional Surveyor No. 035-036352
State of Illinois
EXPIRES 11/30/2024

This professional service conforms to the current Illinois minimum standards for a boundary survey.

The property described and shown hereon is the same property described in Chicago Title Insurance Company Title Commitment No. CCH2308282LD dated April 19, 2024.



EASEMENT NOTES Per Chicago Title Insurance Company Title Commitment No. CCH2308282LD dated April 19, 2024.

J 15. Building line 35 feet North of the South Lot line of the Lot, South of the North Lot line of the Lot and East of the West Lot Line of the Lot, as shown on the Plat of Oak Grove Centre of Commerce Unit One, THIS EASEMENT CROSSES THE SURVEYED PROPERTY AND AFFECTS AS SHOWN HEREOF.

K 16. Utility easement as shown on this Plat and contained in the certificate appended to the Plat of Oak Grove Centre of Commerce Unit One, (affects the North and West 10 feet) THIS EASEMENT CROSSES THE SURVEYED PROPERTY AND AFFECTS AS SHOWN HEREOF.

L 17. Certificate appended to the Plat Oak Grove Centre of Commerce Unit One, aforesaid, Right of Access to All Easements is Also Granted to the Village of Downers Grove and to the Downers Grove Sanitary District for the Purpose of Construction and Maintenance, THE SURVEYED PROPERTY IS INCLUDED WITHIN THIS DOCUMENT. BLANKET IN NATURE, NOT SHOWN.

M 18. Order recorded January 2, 1989 as document No. R89-47 by the State of Illinois, Department of Public Works and buildings, division of Highways, establishing federal aid route 151 as a freeway and providing that access between said freeway and abutting Lands is to be permitted only at entrances provided for that purpose under permits from said department, THIS EASEMENT TOUCHES THE SURVEYED PROPERTY AND AFFECTS AS SHOWN HEREOF.

N 19. Easement created by a grant dated February 7, 1980 and recorded June 9, 1980 as document no. R80-033001, from Commerce Centre II, and others to Northern Illinois Gas, its successors and assigns, for the purpose of laying, maintaining, operating, removing, repairing and replacing gas mains and appurtenant equipment in, upon, under, along and across the following described land an easement over parts of Lots 1 and 2 in Oak Grove Centre of Commerce Unit One described as follows:

commencing at the Northwest Corner of Said Lot 1; Thence South 1 degree 04 minutes 56 seconds East along the East Line of Said Lot, a distance of 245.61 feet to the point of beginning; thence continuing South 1 degree 04 minutes 56 seconds East along said East Line, a distance of 29 feet; thence South 88 degrees 55 minutes 04 seconds West along a line perpendicular to the East Line of said Lot 1, a distance of 10 feet; thence North 1 degree 04 minutes 56 seconds West on a line parallel to the East Line of said Lot 1, a distance of 39 feet; thence North 88 degrees 55 minutes 04 seconds East along a line perpendicular to the East Line of said Lot 1, a distance of 38 feet; thence North 1 degree 04 minutes 56 seconds West on a line parallel to the West Line of Lot 2 a distance of 234.08 feet to the Northernly North of Said Lot 2; thence South 89 degrees 10 minutes 56 seconds East along the Northernly line of Said Lot 2, a distance of 10.005 feet; thence South 1 degree 04 minutes 56 seconds East on a North parallel to the West Line of Said Lot 2, a distance of 243.75 feet; thence South 88 degrees 55 minutes 04 seconds West along a line perpendicular to the West Line of Lot 2, a distance of 58 feet to the point of beginning, all in Oak Grove Centre of Commerce Unit 1, being a Subdivision of part of the East 1/2 of Section 30, Township 39 North, Range 11, East of the Third Principal Meridian, in DuPage county, Illinois, (affects the East and South 10 feet of parcel 2 and a 39 foot by 10 foot strip along the East Lot line of Lot 1) THIS EASEMENT CROSSES THE SURVEYED PROPERTY AND AFFECTS AS SHOWN HEREOF.

P 20. Terms, provisions, and conditions relating to the easement described as Parcel 3 contained in the Instrument creating said easement. Rights of the adjoining owner or owners to the enjoyment use of said easement, THE SURVEYED PROPERTY IS INCLUDED WITHIN THIS DOCUMENT. BLANKET IN NATURE, NOT SHOWN.

O 21. Easements, terms, conditions and provisions contained in the access road construction, operation, maintenance and reciprocal easement agreement recorded under document, recorded June 10, 1982, as document no. R82-29852. Rights of the adjoining owner or owners to the enjoyment use of said easements, (affects Parcel 1 and 3) THIS EASEMENT CROSSES THE SURVEYED PROPERTY AND AFFECTS AS SHOWN HEREOF.

P 22. Easement created by a grant dated April 4, 1980 and recorded April 14, 1980 as document no. R80-21771 from Drovers Bank of Chicago, as trustee under trust agreement dated January 22, 1980 and known as trust number 80012 to the Commonwealth Edison Company, its successors and assigns, to construct and maintain utility service affecting the following described Land:

An easement over parts of Lots 1 and 2 in Oak Grove Centre of Commerce Unit 1, Described as Follows:
Commencing at the Northeast Corner of Said Lot 1; Thence South 01 degree 04 minutes 56 seconds East, along the East Line of Said Lot, a distance of 245.61 feet to the point of beginning; thence South 39 degrees 55 minutes 04 seconds West, along a line perpendicular to East line of said Lot 1, a distance of 10 feet; thence North 01 degree 04 minutes 56 seconds West, on a line parallel to the East Line of said Lot 1 a distance of 10 feet; thence North 88 degrees 55 minutes 04 seconds East, along a line perpendicular to the East line of said Lot 1, a distance of 58 feet; thence North 01 degree 04 minutes 56 seconds West on a line parallel to the West Line of Lot 2, a distance of 234.08 feet to the Northernly line of Said Lot 2; thence South 89 degrees 10 minutes 46 seconds East, along the Northernly line of Said Lot 2, a distance of 10.005 feet; thence South 01 degree 04 minutes 56 seconds East, on a line parallel to the West Line of Said Lot 2, a distance of 243.75 feet; thence South 88 degrees 55 minutes 04 seconds West, along a line perpendicular to the West Line of Lot 2, a distance of 58 feet to the point of beginning; all in Oak Grove Centre of Commerce, Unit 1, aforesaid (Affects a 10-foot by 10-foot portion of Parcel 1 and the North 10 feet, the West 10 feet of the East 20 feet, and the North 10 feet of the South 20 feet of Parcel 2) THIS EASEMENT CROSSES THE SURVEYED PROPERTY AND AFFECTS AS SHOWN HEREOF.

Q 23. Grant of easement dated October 15, 1982 and recorded October 15, 1982 as document no. R80-47387 made by Drovers Bank of Chicago, as trustee under trust agreement dated January 22, 1980 and known as trust number 80012, granting a public utility easement over the East 10 feet of the West 86 feet (as measured at right angles to the West Line thereof) of the Southerly 24 feet of the Northernly 204 feet (as measured at right angles to the North Line thereof) of Lot 2 in Oak Grove Centre of Commerce Unit 1, being a Subdivision of part of the East 1/2 of Section 30, Township 39 North, Range 11, East of the Third Principal Meridian, in DuPage county, Illinois (Affects a portion of parcel 2) THIS EASEMENT CROSSES THE SURVEYED PROPERTY AND AFFECTS AS SHOWN HEREOF.

R 24. Grant made by Joseph Johnson and Catherine M. Johnson, his wife, to Village of Downers Grove, an Illinois Municipal Corporation, its successors and assigns, Dated June 6, 1986 and recorded July 2, 1986 as document no. R86-29394, of the non exclusive perpetual right and easement to construct, operate, repair, maintain, reconstruct and remove an underground sewer and an underground water main together with necessary underground appurtenant facilities for the maintenance and operation of the village combined waterworks and sewage system or any part thereof in, on, over, under and across any of the Lands 10 feet wide in the South East 1/4 of Section 30, Township 39 North, Range 11, East of the Third Principal Meridian, as described therein and as shown on the Plat attached thereto and marked "Exhibit W", together with the provisions and conditions therein contained, and as shown on the Plat of Oak Grove Centre of Commerce Unit One, aforesaid, (Affects Part of Easement Parcel 2 in Parcel 3) THIS EASEMENT CROSSES THE SURVEYED PROPERTY AND AFFECTS AS SHOWN HEREOF.

ENCROACHMENT NOTES

- A. BUILDING OVER SETBACK (EASEMENT ITEM 15).
B. BLANKET OVER EASEMENT LINE.

Blodgett Riggett Cooper James
BRCJ
LAND SURVEYING - CIVIL ENGINEERING - GIS
1501 West Tipp Road Bloomington, Indiana 47403
Phone: 812-336-8277 Email: njm@blodgettcooper.com

BRCJ Project No. 11654
This Survey has been prepared solely for the benefit of the parties set forth in this Surveyors Certificate and may not be quoted or relied upon by, nor may copies be delivered to, any other party or used for any other purpose including, without limitation, the preparation of zoning reports or other third party reports, without The Matthews Company, Inc. and Blodgett Riggett Cooper & James, Inc. in prior written consent. The Matthews Company, Inc. and Blodgett Riggett Cooper & James, Inc. expressly disclaims any duty or obligation towards any party that is not identified in this Surveyors Certificate.

- NOTES:
1. PROPERTY IS LOCATED IN FLOOD ZONE OF FIRM FEMA FLOOD INSURANCE RATE MAP NUMBER 170630101A, DATED 09/01/2019 IF FLOODED, SUBJECT TO MAP SCALE (AS SHOWN).
2. ZONING NOTES:
ZONING JURISDICTION: PROPERTY IS ZONED GENERAL BUSINESS AND RECREATION BUSINESS (B-3). CURRENT USE AS A RETAIL SALES IS ALLOWED.
BUILDING SETBACK:
FRONT - 25'
REAR - 4' (PROVISIONAL) BY RESIDENTIAL HEIGHT RESTRICTIONS. MAXIMUM BUILDING HEIGHT: 10'
OFF-STREET PARKING REQUIREMENTS: 3.5 SPACES PER 1,000 SQ. FT.
THE ZONING INFORMATION ABOVE WAS PROVIDED FROM THE OFFICE OF CHICAGOER GROVE. ZONING ORDINANCE DATED 04/25/2018 AND PER A PHONE CALL TO JASON ZAKARIA (PLANNING MANAGER), PHONE NUMBER (847) 641-0262, ON 07/27/2023 BY THE SURVEYOR.
3. INQUIRY: THERE ARE 414 TOTAL PARKING SPACES ON SITE, 15 OF WHICH ARE DESIGNATED HANDICAP.
4. FIELD WORK PERFORMED MAY 16, 2024.
5. ALL SURVEY SET ARE MARKED WITH GREEN DAP ENGRAVED "TIBBETT & PROSSER" AND ARE PLUSH WITH GREEN POLYURETHANE OVERBURN.
6. THERE IS NO OBSERVABLE EVIDENCE OF EARLY-MORNING MIST, BUILDING CONSTRUCTION OR BUILDING ACTIVITY WITH RECENT WORK.
7. THERE IS NO VISIBLE EVIDENCE OF PROPOSED STREET RIGHT OF WAY CHANGES, R.O.W. IS SHOWN BY CURRENT DEEDS AND TITLE INFORMATION.
8. THERE IS NO OBSERVABLE EVIDENCE OF RECENT STREET OR SIDEWALK CONSTRUCTION OR REPAIRS.
9. ACCESS IS PROVIDED DIRECTLY BY DOWNERS DRIVE AND BROOK DRIVE, PUBLIC STREETS.
10. THIS SURVEY MAP CORRECTLY REPRESENTS THE FACTS FOUND AT THE TIME OF SURVEY.
11. THERE ARE NO DISCREPANCIES BETWEEN THE BOUNDARY LINES OR THE PROPERTY AS SHOWN ON THE SURVEY MAP AND AS DESCRIBED IN THE LEGAL DESCRIPTION PRESENTED IN THE TITLE COMMITMENT.
12. THE BOUNDARY LINE OVERLAP/SHOWN AS SHOWN ON THIS SURVEY MAP FORM A MATHEMATICALLY CLOSED FIGURE WITHIN A 1/4" FOOT.
13. THE BOUNDARY LINE OVERLAP/SHOWN AS SHOWN ON THIS SURVEY MAP FORM A MATHEMATICALLY CLOSED FIGURE WITHIN A 1/4" FOOT.
14. THE BOUNDARY LINES OF THE PROPERTY ARE CONTIGUOUS WITH THE BOUNDARY LINES OF ALL ADJOINING STREETS, HIGHWAYS, RIGHTS OF WAY AND LANDS, PUBLIC OR PRIVATE, AS DESCRIBED IN THE MOST RECENT RESPECTIVE LEGAL DESCRIPTIONS OF RECORD.
15. EXCEPT AS OTHERWISE NOTED BELOW, IF THE PROPERTY CONSISTS OF TWO OR MORE PARCELS, THERE ARE NO CLAIMS OR DISCREPANCIES BETWEEN SAID PARCELS.

"ALTA/NSPS LAND TITLE SURVEY"
PREPARED FOR:



17220 Newberg Street, Suite 10811B, Roseville, Illinois, CA 92708
Tel: (714) 979-7181 Fax: (714) 641-2540
www.themattthewscompany.com

Table with 4 columns: MARK, DATE, REVISION, BY. Rows for 4-4 and 6-24.

JLL Value and Risk Advisory

1432 S. 1434 Butterfield Road
Downers Grove, IL

Table with 2 columns: DATE, CHKD./APVD. Rows for MAY 30, 2024 and DWN BY: VS.



EXTERIOR ELEVATION MATERIALS LEGEND	
MARK	DESCRIPTION
A	FULL-DEPTH MODULAR BRICK (BRK-2)
B	FULL-DEPTH MODULAR BRICK (BRK-1)
C	BRAKE METAL FASCIA (MP-2)
D	SOFFIT PANELS (MP-2)
E	STANDING SEAM ROOF PANELS (MP-2)
F	METAL BRAKE CAP (MP-3)
G	BRAKE METAL FASCIA (MP-1)
H	MASONRY CAP ON TOP OF CMU WALL; COLOR TO MP-3
J	VERTICAL METAL SIDING (MP-4)
K	GUTTER AND DOWNSPOUT; PAINT TO MATCH MP-2

EXTERIOR ELEVATION KEYNOTES	
MARK	DESCRIPTION
1	PRE-ENGINEERED ALUMINUM CANOPY BY OTHERS; REF STRUCTURAL
2	MOUNTED SPEAKER SYSTEM; REF SYSTEMS PLAN
3	THROUGH-WALL ROOF SCUPPER, TYP
4	ADDRESS NUMBERS TO BE 6" TALL x 2" BRUSH STROKE
5	ELECTRICAL EQUIPMENT, PAINTED TO MATCH BUILDING; REF ELECTRICAL
6	FROST-PROOF FLUSH HOSE BIB
7	EXTERIOR WEATHER-PROOF OUTLET; REF ELECTRICAL
8	PARAPET WALL EXTENSIONS AS MECH SCREENING & AS GUARDRAIL PER IBC SECTION 1015
9	KNOX BDX
10	OUTLINE OF MECHANICAL UNIT BEYOND
11	CANVAS CRAFT WARMING HUT, CONSTRUCTED W/ FIRE-RETARDANT FABRIC
12	SAMSUNG DIGITAL DISPLAYS; INSTALLED IN FIELD BY IT PROVIDER; CHASE FOR DATA CABLE INSTALLED AT BUILDING MANUFACTURING FACILITY
13	PAINTED STRUCTURAL CANOPY COLUMN; RAINWATER DOWNSPOUT WITHIN; CONNECT BASE OF CANOPY COLUMN DOWNSPOUT TO STORMWATER MANAGEMENT SYSTEM; REF CIVIL
14	PAINTED STRUCTURAL CANOPY COLUMN; RAINWATER DOWNSPOUT WITHIN; SCUPPER BASE OF DOWNSPOUT TO GRADE; REF CIVIL
15	PAINTED STRUCTURAL CANOPY COLUMN; REF CIVIL
16	TRASH ENCLOSURE; REF AS-4
17	OSHA-COMPLIANT FIXED LADDER W/ SECURITY DOOR

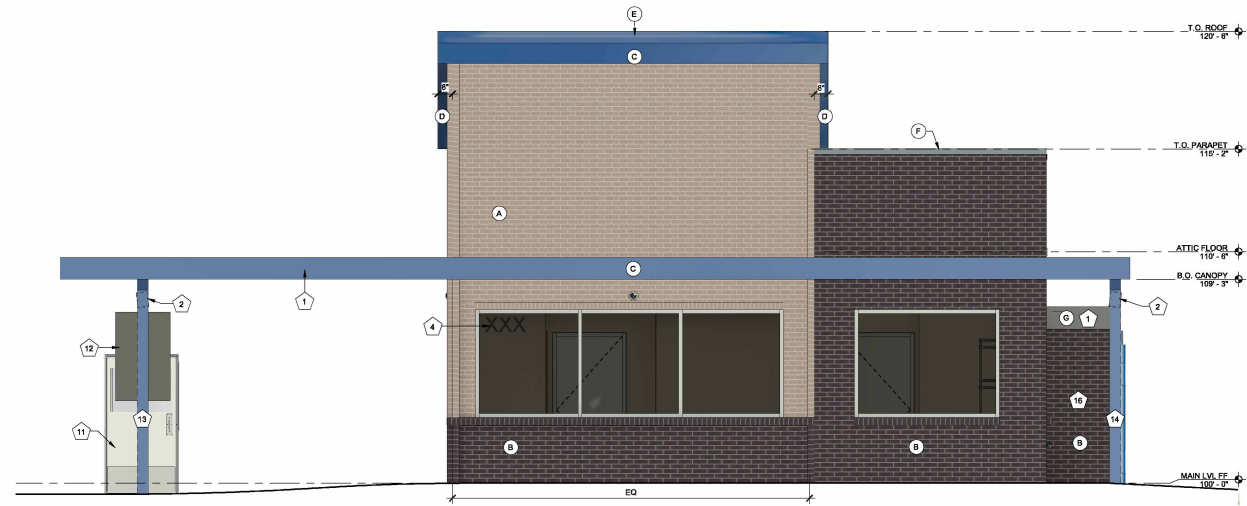

1 EXTERIOR ELEVATION - FRONT
3/8" = 1'-0"

7 BREW DRIVE THRU - DOWNERS GROVE IL - BUTTERFIELD
WHOBREW, LLC
BUTTERFIELD ROAD & DOWNERS DRIVE, DOWNERS GROVE, ILLINOIS 60515

REVISIONS		
No.	Description	Date

Sheet issue date: 11/11/25
Project no.: 23-43-34
Sheet contents: EXTERIOR ELEVATIONS

Sheet no.: A2.0

11/11/2025 12:00:59 PM C:\Users\Vanessa\Documents\23.43.34_Downers Grove IL - Butterfield_Entitlement_Stickbull_R24_vanessaBWH85.rvt
7 Brew Site Constructed Template V1.0
This drawing is an instrument of service and, as such, shall remain the property of Veritas Architecture and Design, LLC. Unauthorized use or reproduction without permission is prohibited. This document is for use in connection with the specified project and shall not be used for other locations. ©2023



707 n. 6th street
 kansas city, ks 66101
 www.veritas-ad.com
 913.308.1460
 consulting engineer:

EXTERIOR ELEVATION MATERIALS LEGEND	
MARK	DESCRIPTION
A	FULL-DEPTH MODULAR BRICK (BRK-2)
B	FULL-DEPTH MODULAR BRICK (BRK-1)
C	BRAKE METAL FASCIA (MP-2)
D	SOFFIT PANELS (MP-2)
E	STANDING SEAM ROOF PANELS (MP-2)
F	METAL BRAKE CAP (MP-3)
G	BRAKE METAL FASCIA (MP-1)
H	MASONRY CAP ON TOP OF CMU WALL; COLOR TO MP-3
J	VERTICAL METAL SIDING (MP-1)
K	GUTTER AND DOWNSPOUT; PAINT TO MATCH MP-2

EXTERIOR ELEVATION KEYNOTES	
MARK	DESCRIPTION
1	PRE-ENGINEERED ALUMINUM CANOPY BY OTHERS; REF STRUCTURAL
2	MOUNTED SPEAKER SYSTEM; REF SYSTEMS PLAN
3	THROUGH-WALL ROOF SCUPPER, TYP
4	ADDRESS NUMBERS TO BE 6" TALL x 2" BRUSH STROKE
5	ELECTRICAL EQUIPMENT, PAINTED TO MATCH BUILDING; REF ELECTRICAL
6	FROST-PROOF FLUSH HOSE BIB
7	EXTERIOR WEATHER-PROOF OUTLET; REF ELECTRICAL
8	PARAPET WALL EXTENSIONS AS MECH SCREENING & AS GUARDRAIL PER IBC SECTION 1015
9	KNOX BDX
10	OUTLINE OF MECHANICAL UNIT BEYOND
11	CANVAS CRAFT WARMING HUT, CONSTRUCTED W/ FIRE-RETARDANT FABRIC
12	SAMSUNG DIGITAL DISPLAYS; INSTALLED IN FIELD BY IT PROVIDER; CHASE FOR DATA CABLE INSTALLED AT BUILDING MANUFACTURING FACILITY
13	PAINTED STRUCTURAL CANOPY COLUMN; RAINWATER DOWNSPOUT WITHIN; CONNECT BASE OF CANOPY COLUMN DOWNSPOUT TO STORMWATER MANAGEMENT SYSTEM; REF CIVIL
14	PAINTED STRUCTURAL CANOPY COLUMN; RAINWATER DOWNSPOUT WITHIN; SCUPPER BASE OF DOWNSPOUT TO GRADE; REF CIVIL
15	PAINTED STRUCTURAL CANOPY COLUMN; REF CIVIL
16	TRASH ENCLOSURE; REF AS-4
17	OSHA-COMPLIANT FIXED LADDER W/ SECURITY DOOR

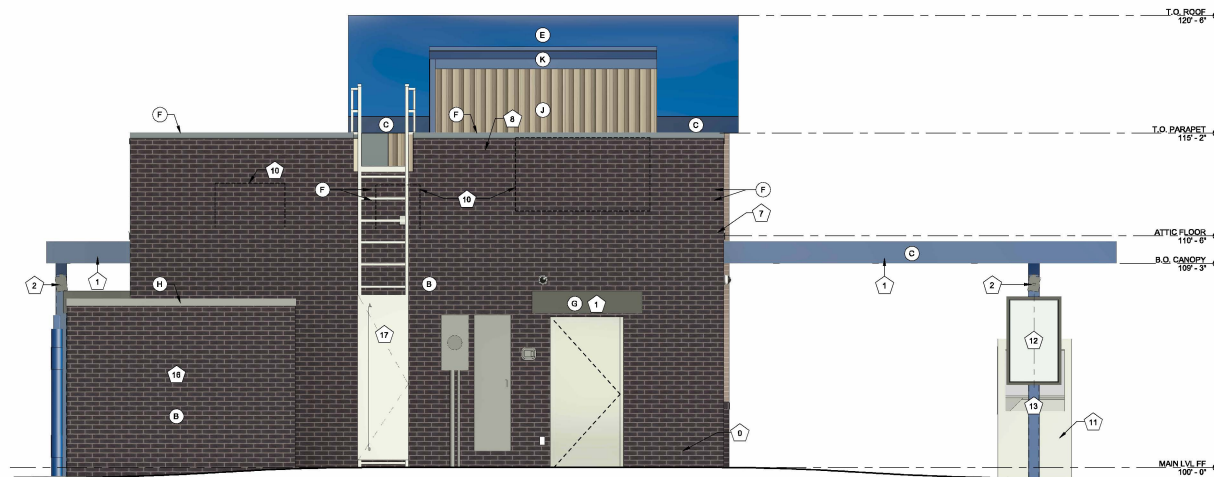

1 EXTERIOR ELEVATION - REAR
 3/8" = 1'-0"

7 BREW DRIVE THRU - DOWNERS GROVE IL - BUTTERFIELD
 WHOBREW, LLC
 BUTTERFIELD ROAD & DOWNERS DRIVE, DOWNERS GROVE, ILLINOIS 60515

REVISIONS		
No.	Description	Date

Sheet issue date:
 11/11/25
 Project no.:
 23-43-34
 Sheet contents:
 EXTERIOR ELEVATIONS

Sheet no.:
A2.1

11/11/2025 12:01:05 C:\Users\Vanessa\Documents\23.43.34_Downers Grove IL - Butterfield_Entitlement_Stickbull_R24_vanessaBWH85.rvt
 PM
 This drawing is an instrument of service and, as such, shall remain the property of Veritas Architecture and Design, LLC. Unauthorized use or reproduction without permission is prohibited. This document is for use in connection with the specified project and shall not be used for other locations. ©2023
 7 Brew Site Constructed Template V1.0



EXTERIOR ELEVATION MATERIALS LEGEND	
MARK	DESCRIPTION
A	FULL-DEPTH MODULAR BRICK (BRK-2)
B	FULL-DEPTH MODULAR BRICK (BRK-1)
C	BRAKE METAL FASCIA (MP-2)
D	SOFFIT PANELS (MP-2)
E	STANDING SEAM ROOF PANELS (MP-2)
F	METAL BRAKE CAP (MP-3)
G	BRAKE METAL FASCIA (MP-1)
H	MASONRY CAP ON TOP OF CMU WALL; COLOR TO MP-3
J	VERTICAL METAL SIDING (MP-4)
K	GUTTER AND DOWNSPOUT; PAINT TO MATCH MP-2

EXTERIOR ELEVATION KEYNOTES	
MARK	DESCRIPTION
1	PRE-ENGINEERED ALUMINUM CANOPY BY OTHERS; REF STRUCTURAL
2	MOUNTED SPEAKER SYSTEM; REF SYSTEMS PLAN
3	THROUGH-WALL ROOF SCUPPER, TYP
4	ADDRESS NUMBERS TO BE 6" TALL x 2" BRUSH STROKE
5	ELECTRICAL EQUIPMENT, PAINTED TO MATCH BUILDING; REF ELECTRICAL
6	FROST-PROOF FLUSH HOSE BIB
7	EXTERIOR WEATHER-PROOF OUTLET; REF ELECTRICAL
8	PARAPET WALL EXTENSIONS AS MECH SCREENING & AS GUARDRAIL PER IBC SECTION 1015
9	KNOX BDX
10	OUTLINE OF MECHANICAL UNIT BEYOND
11	CANVAS CRAFT WARMING HUT; CONSTRUCTED W/ FIRE-RETARDANT FABRIC
12	SAMSUNG DIGITAL DISPLAYS; INSTALLED IN FIELD BY IT PROVIDER; CHASE FOR DATA CABLE INSTALLED AT BUILDING MANUFACTURING FACILITY
13	PAINTED STRUCTURAL CANOPY COLUMN; RAINWATER DOWNSPOUT WITHIN; CONNECT BASE OF CANOPY COLUMN DOWNSPOUT TO STORMWATER MANAGEMENT SYSTEM; REF CIVIL
14	PAINTED STRUCTURAL CANOPY COLUMN; RAINWATER DOWNSPOUT WITHIN; SCUPPER BASE OF DOWNSPOUT TO GRADE; REF CIVIL
15	PAINTED STRUCTURAL CANOPY COLUMN; REF CIVIL
16	TRASH ENCLOSURE REF. A5.4
17	OSHA-COMPLIANT FIXED LADDER W/ SECURITY DOOR

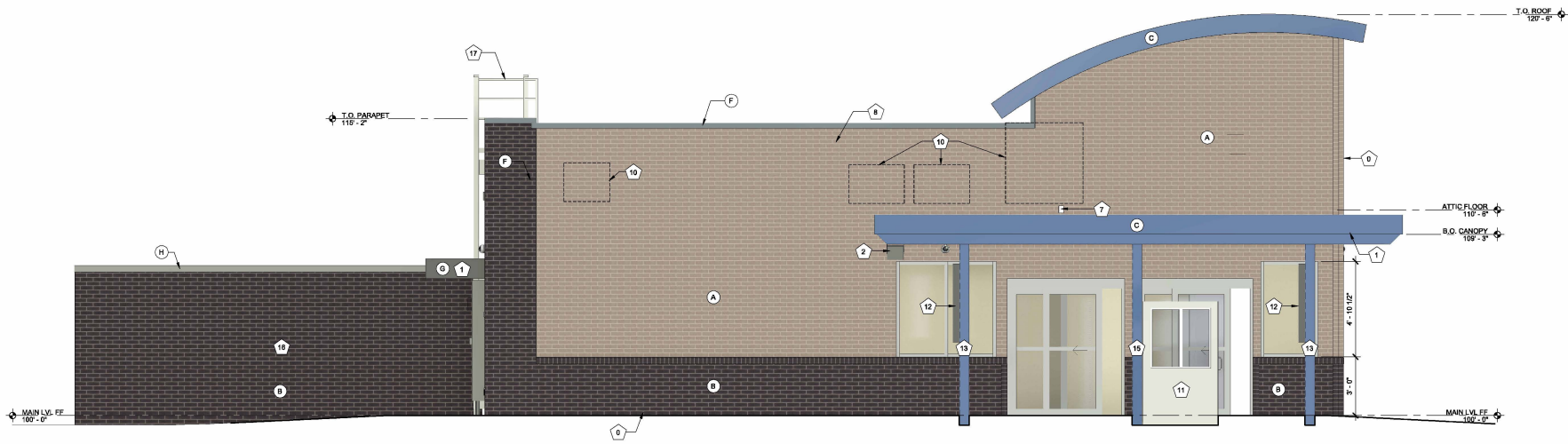

1 EXTERIOR ELEVATION - RIGHT
3/8" = 1'-0"

7 BREW DRIVE THRU - DOWNERS GROVE IL - BUTTERFIELD
WHOBREW, LLC
BUTTERFIELD ROAD & DOWNERS DRIVE, DOWNERS GROVE, ILLINOIS 60515

REVISIONS		
No.	Description	Date

sheet issue date:
11/11/25
project no.:
23.43.34
sheet contents:
EXTERIOR ELEVATIONS

sheet no.:
A2.2

11/11/2025 12:01:11 PM C:\Users\Vanessa\Documents\23.43.34_Downers Grove IL - Butterfield_Entitlement_Stickbull_R24_vanessaBWH85.rvt
7 Brew Site Constructed Template V1.0
This drawing is an instrument of service and, as such, shall remain the property of Veritas Architecture and Design LLC. Unauthorized use or reproduction without permission is prohibited. This document is for use in connection with the specified project and shall not be used for other locations. ©2023

11/11/2025 12:01:18 PM C:\Users\Vanessa\Documents\23.43.34_Downers Grove IL - Butterfield_Entitlement_Stickbull_R24_vanessaBWH85.rvt
7 Rows See Constructed Template V1.0
This drawing is an instrument of service and, as such, shall remain the property of Veritas Architecture and Design, LLC. Unauthorized use or reproduction without permission is prohibited. This document is for use in connection with the specified project and shall not be used for other locations. ©2023



veritas
architecture + design

707 n. 6th street
kansas city, ks 66101
www.veritas-ad.com
913.308.1460
consulting engineer:

EXTERIOR ELEVATION MATERIALS LEGEND	
MARK	DESCRIPTION
A	FULL-DEPTH MODULAR BRICK (BRK-2)
B	FULL-DEPTH MODULAR BRICK (BRK-1)
C	BRAKE METAL FASCIA (MP-2)
D	SOFFIT PANELS (MP-2)
E	STANDING SEAM ROOF PANELS (MP-2)
F	METAL BRAKE CAP (MP-3)
G	BRAKE METAL FASCIA (MP-1)
H	MASONRY CAP ON TOP OF CMU WALL; COLOR TO MP-3
J	VERTICAL METAL SIDING (MP-4)
K	GUTTER AND DOWNSPOUT; PAINT TO MATCH MP-2

EXTERIOR ELEVATION KEYNOTES	
MARK	DESCRIPTION
1	PRE-ENGINEERED ALUMINUM CANOPY BY OTHERS; REF STRUCTURAL
2	MOUNTED SPEAKER SYSTEM; REF SYSTEMS PLAN
3	THROUGH-WALL ROOF SCUPPER, TYP
4	ADDRESS NUMBERS TO BE 8" TALL x 2" BRUSH STROKE
5	ELECTRICAL EQUIPMENT, PAINTED TO MATCH BUILDING; REF ELECTRICAL
6	FROST-PROOF FLUSH HOSE BIB
7	EXTERIOR WEATHER-PROOF OUTLET; REF ELECTRICAL
8	PARAPET WALL EXTENSIONS AS MECH SCREENING & AS GUARDRAIL PER IBC SECTION 1015
9	KNOX BDX
10	OUTLINE OF MECHANICAL UNIT BEYOND
11	CANVAS CRAFT WARMING HUT, CONSTRUCTED W/ FIRE-RETARDANT FABRIC
12	SAMSUNG DIGITAL DISPLAYS; INSTALLED IN FIELD BY IT PROVIDER; CHASE FOR DATA CABLE INSTALLED AT BUILDING MANUFACTURING FACILITY
13	PAINTED STRUCTURAL CANOPY COLUMN; RAINWATER DOWNSPOUT WITHIN; CONNECT BASE OF CANOPY COLUMN DOWNSPOUT TO STORMWATER MANAGEMENT SYSTEM; REF CIVIL
14	PAINTED STRUCTURAL CANOPY COLUMN; RAINWATER DOWNSPOUT WITHIN; SCUPPER BASE OF DOWNSPOUT TO GRADE; REF CIVIL
15	PAINTED STRUCTURAL CANOPY COLUMN; REF CIVIL
16	TRASH ENCLOSURE; REF AS-4
17	OSHA-COMPLIANT FIXED LADDER W/ SECURITY DOOR

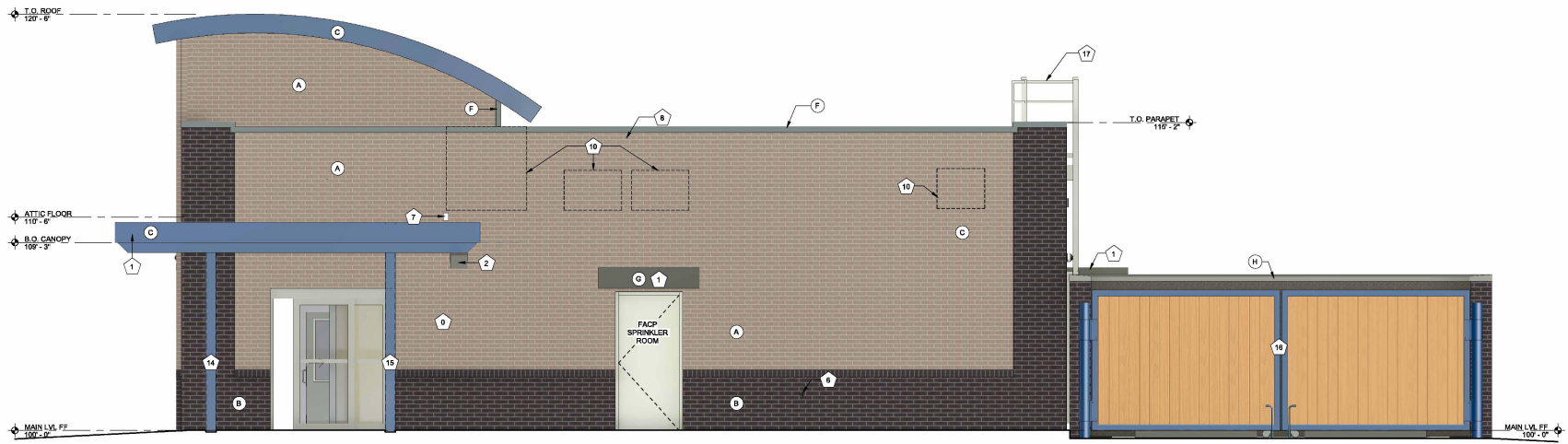

1 EXTERIOR ELEVATION - LEFT
3/8" = 1'-0"

7 BREW DRIVE THRU - DOWNERS GROVE IL - BUTTERFIELD
WHOBREW, LLC
BUTTERFIELD ROAD & DOWNERS DRIVE, DOWNERS GROVE, ILLINOIS 60515

REVISIONS		
No.	Description	Date

Sheet issue date: 11/11/25
Project no.: 23.43.34
Sheet contents: EXTERIOR ELEVATIONS

Sheet no.: A2.3

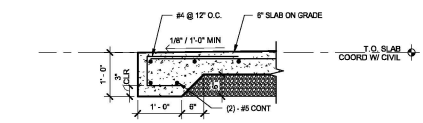

5 ENCLOSURE DETAIL - APRON
3/4" = 1'-0"

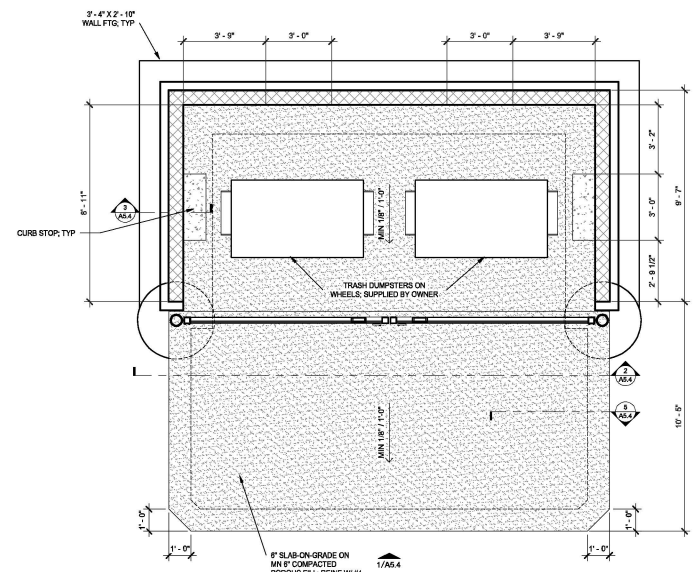

4 ENCLOSURE PLAN
3/8" = 1'-0"

Note Number	Note Text
1	MASONRY CAP ON TOP OF CMU WALL; COLOR TO MATCH ZINC GREY MP-3
2	1X6 VERTICAL CLEAR SEALED CEDAR PLANKS
3	ALL METAL FRAMING, POST AND HARDWARE 1 COAT POR-15 PRIMER AND 2 COATS FINISH. PAINT TO BE OIL BASED; COLOR TO MATCH ROYAL BLUE MP-2
4	BRK-1 OVER CMU

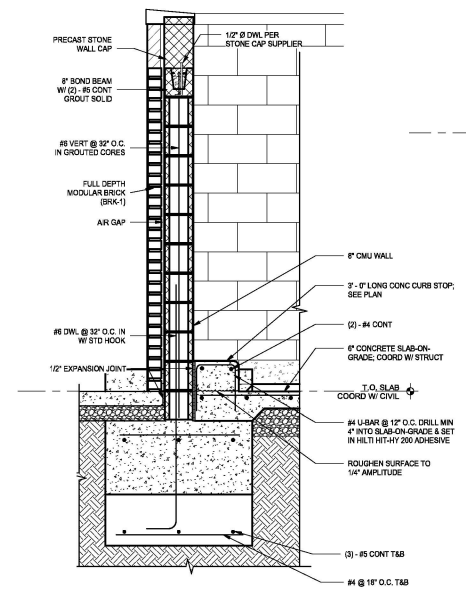

3 ENCLOSURE SECTION - WALL
3/4" = 1'-0"

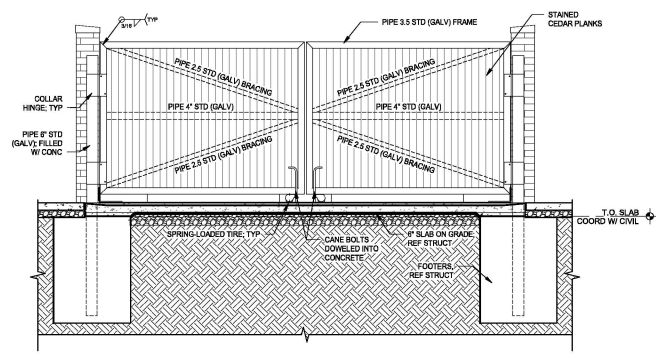

2 ENCLOSURE SECTION - FRONT
3/8" = 1'-0"

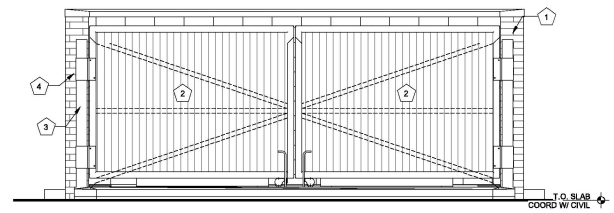

1 ENCLOSURE ELEVATION - FRONT
3/8" = 1'-0"

7 BREW DRIVE THRU - DOWNERS GROVE IL - BUTTERFIELD
WHOBREW, LLC
BUTTERFIELD ROAD & DOWNERS DRIVE, DOWNERS GROVE, ILLINOIS 60515

REVISIONS	No.	Description	Date

sheet issue date:
11/11/25
project no.:
23-43-34
sheet contents:
TRASH ENCLOSURE

sheet no.:
A5.4



707 n. 6th street
kansas city, ks 66101
www.veritas-ad.com
913.308.1460
consulting engineer:

7 BREW DRIVE THRU - DOWNERS GROVE IL - BUTTERFIELD
WHOBREW, LLC
BUTTERFIELD ROAD & DOWNERS DRIVE, DOWNERS GROVE, ILLINOIS 60515

REVISIONS		
No.	Description	Date

sheet issue date: 11/11/25
project no.: 23-43.34
sheet contents: FLOOR PLAN

sheet no.: A1.2

FLOOR PLAN KEYNOTES	
MARK	DESCRIPTION
1	18" x 24" CHAMFERED MOP SINK REF PLUMBING
2	MECH. ACCESS DOOR AND LADDER - SUPPLIED BY OWNER
3	STEP, CENTER ON DOOR
4	FABRICATED STEEL MECHANICAL SERVICE GUARDRAIL PER IBC SECTION 1015 - EACH SIDE
5	CANVAS CRAFT WARMING HUT; CONSTRUCTED W/ FIRE-RETARDANT FABRIC
6	ADA AUTO/MANUAL EGRESS CAPABLE
7	ELECTRICAL EQUIPMENT, PAINTED TO MATCH BUILDING; REF ELECTRICAL
8	TRASH ENCLOSURE RE. AS.4
9	DOWNSPOUT CONNECTION TO STORMWATER SYSTEM; REF CIVIL
10	CONTRACTOR TO COORDINATE CIVIL AND STRUCTURAL DRAWINGS TO ENSURE ALL CANOPY COLUMN FOUNDATION PLATES AND BOLTS ARE CONSTRUCTED IN A MANNER THAT CONCEALS THEIR CONNECTIONS COMPLETELY BELOW GRADE. TYP.
11	DOWNSPOUT OUTLET - STORMWATER CONNECTION; COORD W/ CIVIL
12	FROST-PROTECTED EGRESS FOUNDATION PAD
13	OSHA COMPLIANT FIXED LADDER W/ SECURITY DOOR

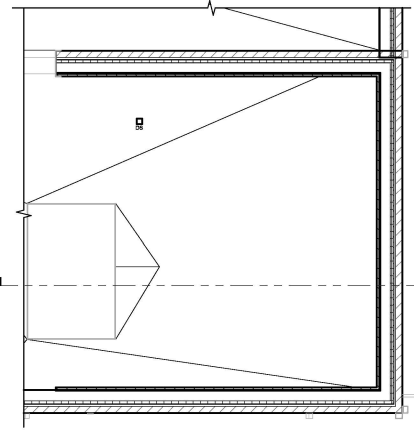

2 MECH ACCESS RM
3/8" = 1'-0"

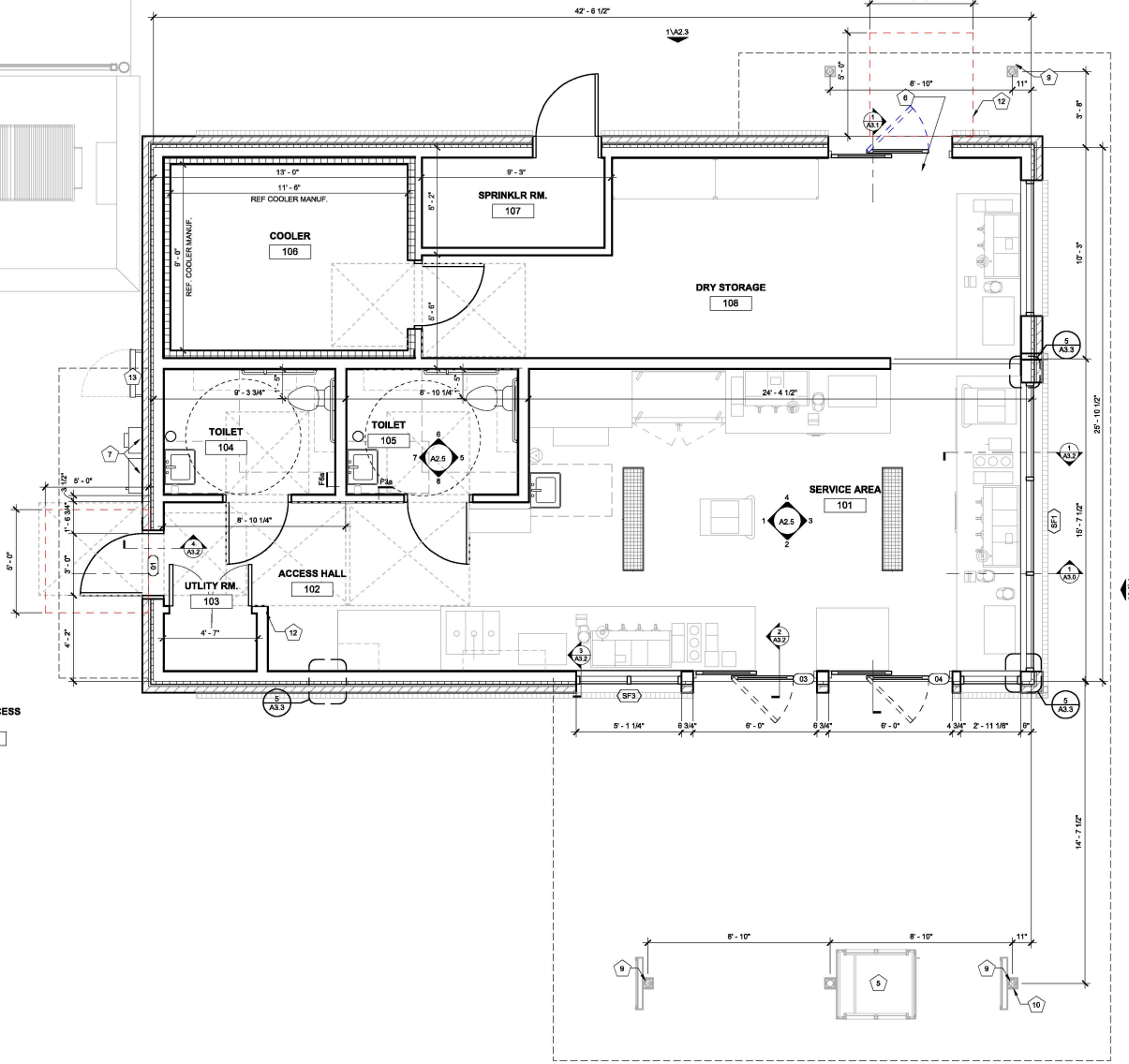

1 FLOOR PLAN
3/8" = 1'-0"

11/11/2025 12:00:52 C:\Users\Vanessa\Documents\23.43.34_Downers Grove IL - Butterfield_Entitlement_Sticobuil_R24_vanessaBWH85.rvt
7 brew site constructed Template V1.0
2025-11-20_LAYOUT V04

This drawing is an instrument of service and, as such, shall remain the property of Veritas Architecture and Design, LLC. Unauthorized use or reproduction without permission is prohibited. This document is for use in connection with the specified project and shall not be used for other locations. C2023

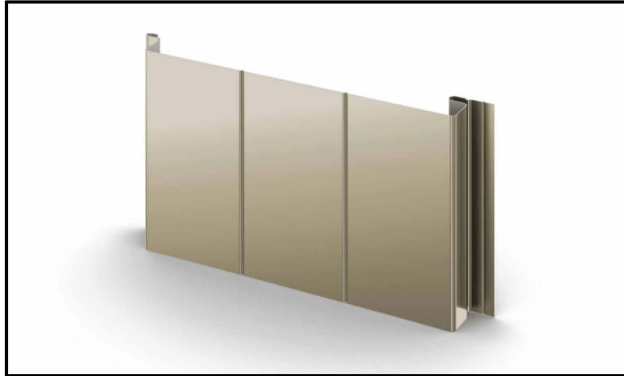

METAL SIDING MP-4
 BRAND: BERRIDGE
 COLOR: SIERRA TAN
 STYLE: FW-12



COPING TRIM METAL MP-3
 BRAND: BERRIDGE
 COLOR: ZINC GREY
 FINISH: LOW SHEEN SMOOTH - REFLECTIVITY .39



BLUE METAL PANEL MP-2
 BRAND: BERRIDGE
 COLOR: ROYAL BLUE
 FINISH: LOW SHEEN SMOOTH - REFLECTIVITY .26

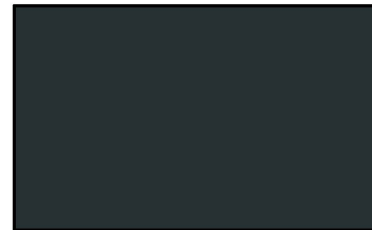

BLACK METAL PANEL MP-1
 BRAND: BERRIDGE
 COLOR: BLACK
 FINISH: LOW SHEEN SMOOTH - REFLECTIVITY .26



FULL DEPTH BRICK - BRK-2
 BRAND: HEBRON
 COLOR: SILVERADO
 FINISH: VELOUR



FULL DEPTH BRICK - BRK-1
 BRAND: HEBRON
 COLOR: ONYX IRONSPOT
 FINISH: RUSTIC



23.43.34
7 BREW DRIVE THRU -
DOWNERS GROVE IL -
BUTTERFIELD
 11/11/25

MATERIAL COLOR
 BOARD



23.43.34
7 BREW DRIVE THRU -
DOWNERS GROVE IL -
BUTTERFIELD
11/11/25

RENDERINGS

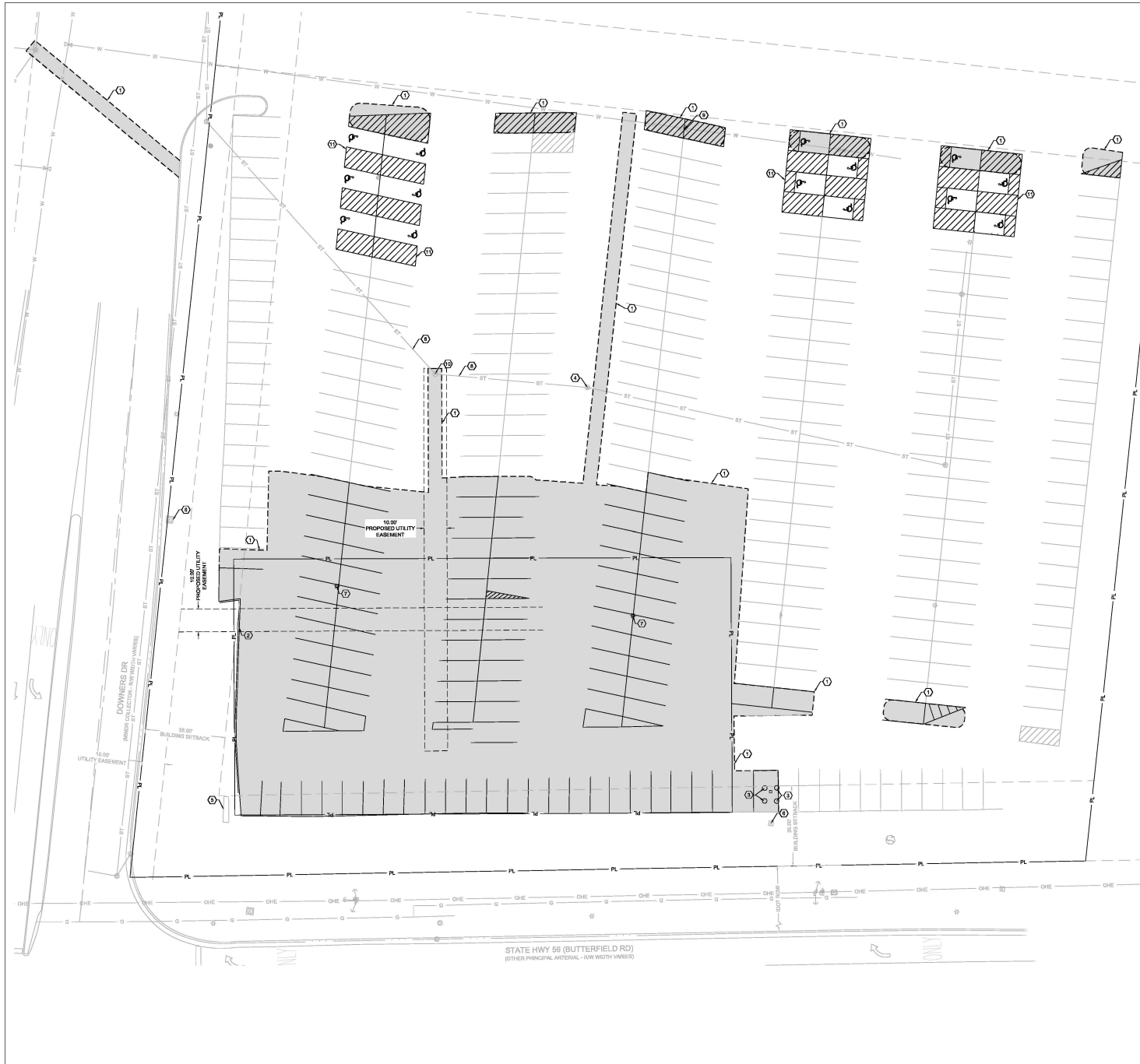

HATCH LEGEND:
 [Hatched Box] = 38,364 S.F. ASPHALT AREA TO BE REMOVED.

- KEY NOTES:**
- ① SAW CUT CLEAN EDGE FOR PAVEMENT REMOVAL. PROTECT EDGE OF PAVEMENT DURING CONSTRUCTION.
 - ② REMOVE 90 L.F. x 4" OF CONCRETE CURB.
 - ③ REMOVE POST BASE.
 - ④ EXISTING STORM AREA INLET, DO NOT DISTURB.
 - ⑤ EXISTING MONUMENT SIGN, DO NOT DISTURB.
 - ⑥ EXISTING ELECTRIC BOX, DO NOT DISTURB.
 - ⑦ REMOVE LIGHT POLE WITH CONCRETE BASE.
 - ⑧ EXISTING 12" RCP STORM LINE, DO NOT DISTURB.
 - ⑨ FIRE HYDRANT TO REMAIN.
 - ⑩ EXISTING STORM AREA INLET, MODIFY PER SHEET C4.1.
 - ⑪ HYDROBLAST EXISTING ADA STRIPING.



ENGINEER OF RECORD:
 NAME: MATTHEW STEVEN MILLER
 LICENSE NO.: E. #PE 06206164
 EXP.: 11/30/2027

PROJECT NUMBER:
 10408

REVISION:

7 BREW COFFEE
DOWNERS GROVE, IL 02
 1434 BUTTERFIELD RD
 DOWNERS GROVE, IL 60515

C1.1

DEMOLITION PLAN

DATE: DECEMBER 9TH, 2025



H. SCALE: 1" = 20'

Call Before You Dig
ILLINOIS ONE-CALL SYSTEM
 Simply Call 811
 www.illinois1call.com

ATOTH & ASSOCIATES
 1501 E. REPUBLIC ROAD
 SPRINGFIELD, MO 65804
 PH: 417-883-0645 Fax: 417-888-0627
 www.atoth.com
 ELP 63026861
 © 2025 ATOTH and Associates, Inc.

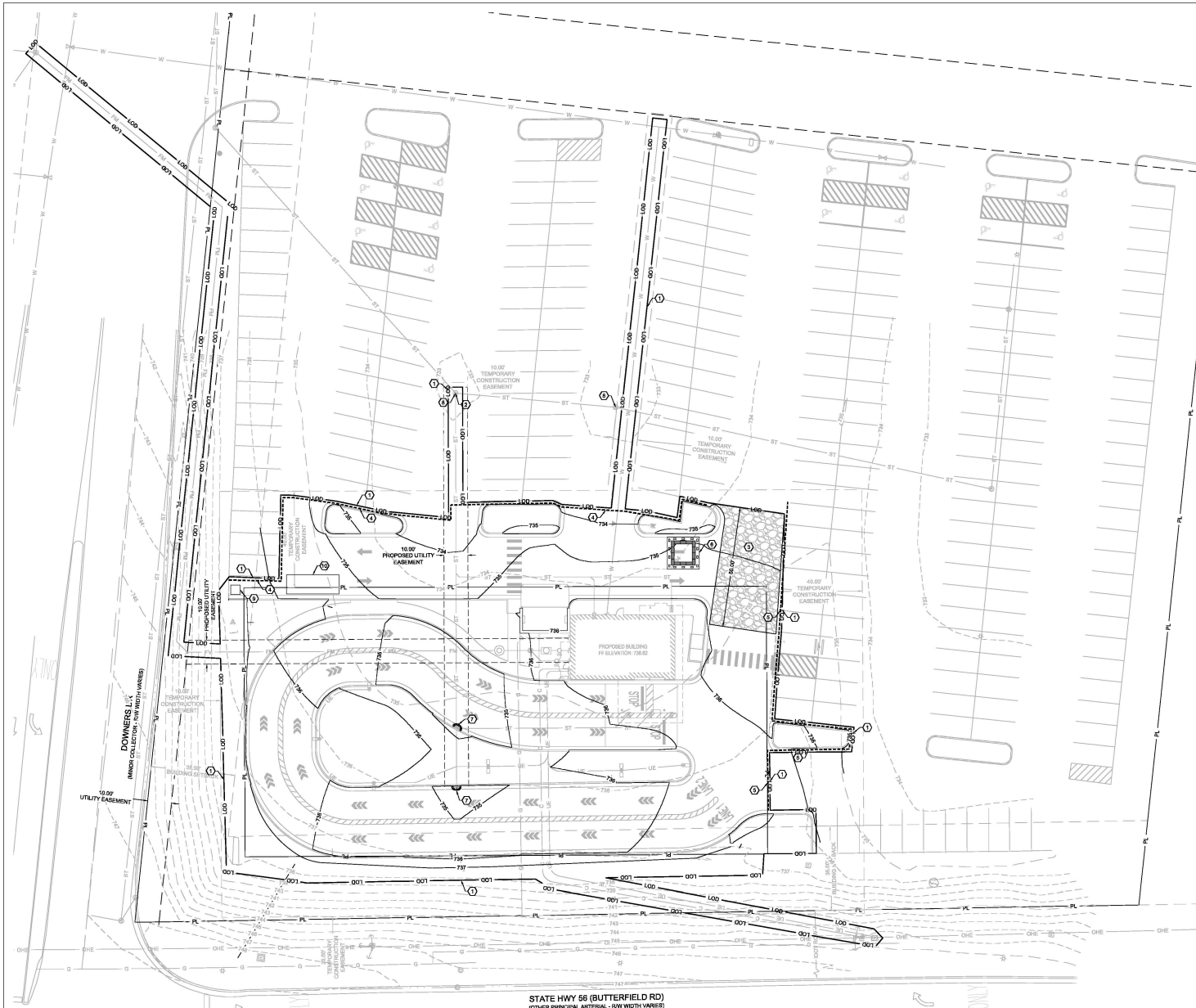

- KEY NOTES:**
- ① LIMITS OF DISTURBANCE = 0.50 ACRES.
 - ② PROPOSED CUTFALL.
 - ③ TEMPORARY CONSTRUCTION ENTRANCE PER DETAIL 1.01, SHEET C7.1.
 - ④ 248 L.F. ± OF COMPOST FILTER BOOK PER DETAIL IUM-514, SHEET C7.5.
 - ⑤ 192 L.F. ± OF COMPOST FILTER BOOK PER DETAIL IUM-514, SHEET C7.5.
 - ⑥ CONCRETE WASHOUT PER DETAIL 1.03, SHEET C7.1. SHOWN LOCATION IS APPROXIMATE.
 - ⑦ CURB INLET PROTECTION PER DETAIL IUM-561C, SHEET C7.5.
 - ⑧ ANSA INLET PROTECTION PER DETAIL IUM-561D, SHEET C7.5.
 - ⑨ PORTABLE RESTROOM, SHOWN LOCATION IS APPROXIMATE.
 - ⑩ DUMPSTER, SHOWN LOCATION IS APPROXIMATE.

PHASING TABLE:		
PHASE	CONSTRUCTION ACTIVITIES	BEST MANAGEMENT PRACTICES INSTALLED
PHASE 1 (PRE-CONSTRUCTION)	INSTALLATION OF PRE-CON BMP'S	- TREE PROTECTION - CONSTRUCTION ENTRANCE - PERIMETER CONTROL (BILT BODQ)
PHASE 2	CLEARING	- RETAIN TOPSOIL - STOCKPILE PROTECTION - DUST CONTROL
PHASE 3	CONSTRUCTION	- CONCRETE WASHOUT PIT - CONSTRUCTION ENTRANCE - TEMPORARY SEEDING
PHASE 4 (FINAL STABILIZATION)	FINAL STABILIZATION OF ALL DISTURBED AREAS	- HYDROSEED - SEED / STRAW



ENGINEER OF RECORD:
 NAME: MATTHEW STEVEN MILLER
 LICENSE NO. E. #PE 062 0814
 EXP. 1/30/2027

PROJECT NUMBER:
 10458
 REVISION:

7 BREW COFFEE
DOWNERS GROVE, IL 02
 1434 BUTTERFIELD RD
 DOWNERS GROVE, IL 60515

STATE HWY 56 (BUTTERFIELD RD)
 (OTHER PRINCIPAL ARTERIAL - RW WIDTH VARIES)



H. SCALE: 1" = 20'



C1.2
 EROSION CONTROL PLAN
 DATE: DECEMBER 9TH, 2025

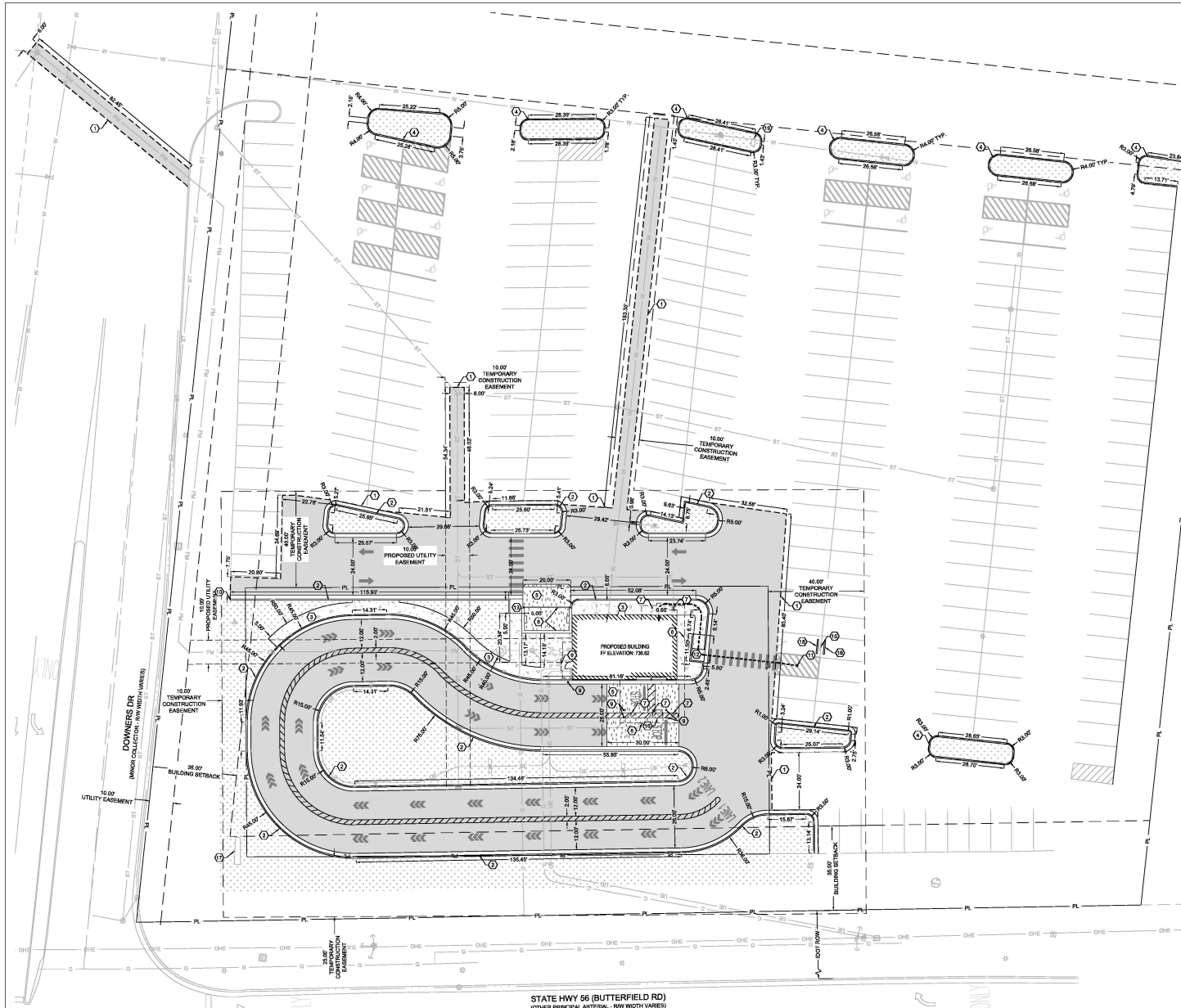

STATE HWY 56 (BUTTERFIELD RD)
(OTHER PRINCIPAL ARTERIAL - RW WIDTH VARIES)

- HATCH LEGEND:**
- ASPHALT PAVEMENT
PER DETAIL 2.08, SHEET C7.1.
 - CONCRETE SIDEWALK
PER SIDEWALK DETAIL 2.02, SHEET C7.1.
 - CONCRETE PAVEMENT
PER CONCRETE PAVEMENT DETAILS 2.03 AND 2.06, SHEET C7.1.
 - LANDSCAPE AREA
REFER TO LANDSCAPE PLAN.

- KEY NOTES:**
- ① MATCH EXISTING PAVEMENT.
 - ② CONCRETE CURB & GUTTER PER CITY DETAIL, SHEET C7.4.
 - ③ SIDEWALK PER DETAIL 2.02, SHEET C7.1.
 - ④ 4" CONCRETE CURB WITH NO OUTER.
 - ⑤ CONCRETE PAVEMENT PER CONCRETE PAVEMENT DETAILS 2.03 & 2.06, SHEET C7.1.
 - ⑥ BUILDING CANOPY OUTLINE.
 - ⑦ CANOPY COLUMN LOCATIONS, TYPICAL.
 - ⑧ TRASH ENCLOSURE AND GATE, PER ARCHITECTURAL PLANS.
 - ⑨ 3" PIPE BOLLARD, TYPICAL PER DETAIL 2.09, SHEET C7.1.
 - ⑩ CURB TRANSITION PER DETAIL 2.15, SHEET C7.1.
 - ⑪ ACCESSIBLE PATH FROM PARKING TO BUILDING.
 - ⑫ MODIFIED TYPE 2 ADA CURB RAMP PER CITY DETAIL, SHEET C7.4.
 - ⑬ TYPE 4 ADA CURB RAMP PER CITY DETAIL, SHEET C7.4.
 - ⑭ SIGN, SEE SHEET C6.1.
 - ⑮ CANVAS CRAFT WARNING HUL PER ARCHITECTURAL PLANS.
 - ⑯ EXISTING MONUMENT SIGN.
 - ⑰ CONCRETE WHEEL STOP.
 - ⑱ DIRECTIONAL SIGN.

PROPOSED USE:
RESTAURANT WITH DRIVE THRU.

ZONING:
ZONING DISTRICT: BS, GENERAL SERVICE & HIGHWAY BUSINESS

PARKING REQUIREMENTS: 7 BREW
REQUIRED: 1 SPACE PER EMPLOYEES DURING LARGEST SHIFT - 6 STALLS.
PROVIDED: 7 STALLS, 6 STANDARD AND 1 ADA.

PARKING REQUIREMENTS: PUD DEVELOPMENT
REQUIRED: 1862.1 S.F. @ 3.5 PARKING SPACE / 1000 S.F. OF BUILDING AREA = 362
PROVIDED: POST 7 BREW DEVELOPMENT: 305 STALLS.

DRIVE-THRU QUEUE STACKING REQUIREMENTS:
REQUIRED: 8 SPACES
PROVIDED: 36 SPACES.

STORMWATER NOTES:

PRE-PROJECT IMPERVIOUS AREA = 33,773 S.F.
PRE-PROJECT PERVIOUS AREA = 5,813 S.F.
TOTAL = 39,586 S.F.

POST-PROJECT IMPERVIOUS AREA = 26,994 S.F.
POST-PROJECT PERVIOUS AREA = 12,404 S.F.
TOTAL = 39,398 S.F.

NOTES:
IMPERVIOUS AND PERVIOUS SURFACE CALCULATIONS ARE BOUNDED BY SAWCUT LINES TO THE NORTH AND EAST, AND LIMIT OF DISTURBANCE TO THE SOUTH AND WEST.

BUILDING AND LOT DATA:
PROJECT FOOTPRINT 33,202 S.F. = 0.76 ACRES
PROPOSED BUILDING (1 STORY) - RETAIL = 1,772 S.F.
CONSTRUCTION TYPE: V-8

QUANTITIES:

- CURB & GUTTER = 1,390 L.F.
- ASPHALT PAVEMENT = 20,772 S.F.
- 8-INCH CONCRETE PAVEMENT = 1,775 S.F.
- 4-INCH CONCRETE SIDEWALK = 1,662 S.F.
- LANDSCAPING = 13,171 S.F.

NOTES:
ANY CHANGES MADE TO THE SITE PLAN OR IN THE FIELD DURING CONSTRUCTION MUST BE SUBMITTED IN WRITING TO THE VILLAGE OF DOWNERS GROVE.



H. SCALE: 1" = 20'



ATOTH & ASSOCIATES
1500 E. REPUBLIC ROAD
SPRINGFIELD, ILLINOIS 62704
PH: 417-883-0645 Fax: 417-888-0607
www.atothinc.com
E# 6302661
© 2025 T&A and Associates, Inc.



ENGINEER OF RECORD:
NAME: MATTHEW STEVEN MILLER
LICENSE NO.: E. #PE 06256164
EXP. 11/30/2027

PROJECT NUMBER:
104508

REVISION:

7 BREW COFFEE
DOWNERS GROVE, IL 02
 1434 BUTTERFIELD RD
 DOWNERS GROVE, IL 60515

C2.1
SITE PLAN
DATE: DECEMBER 9TH, 2025

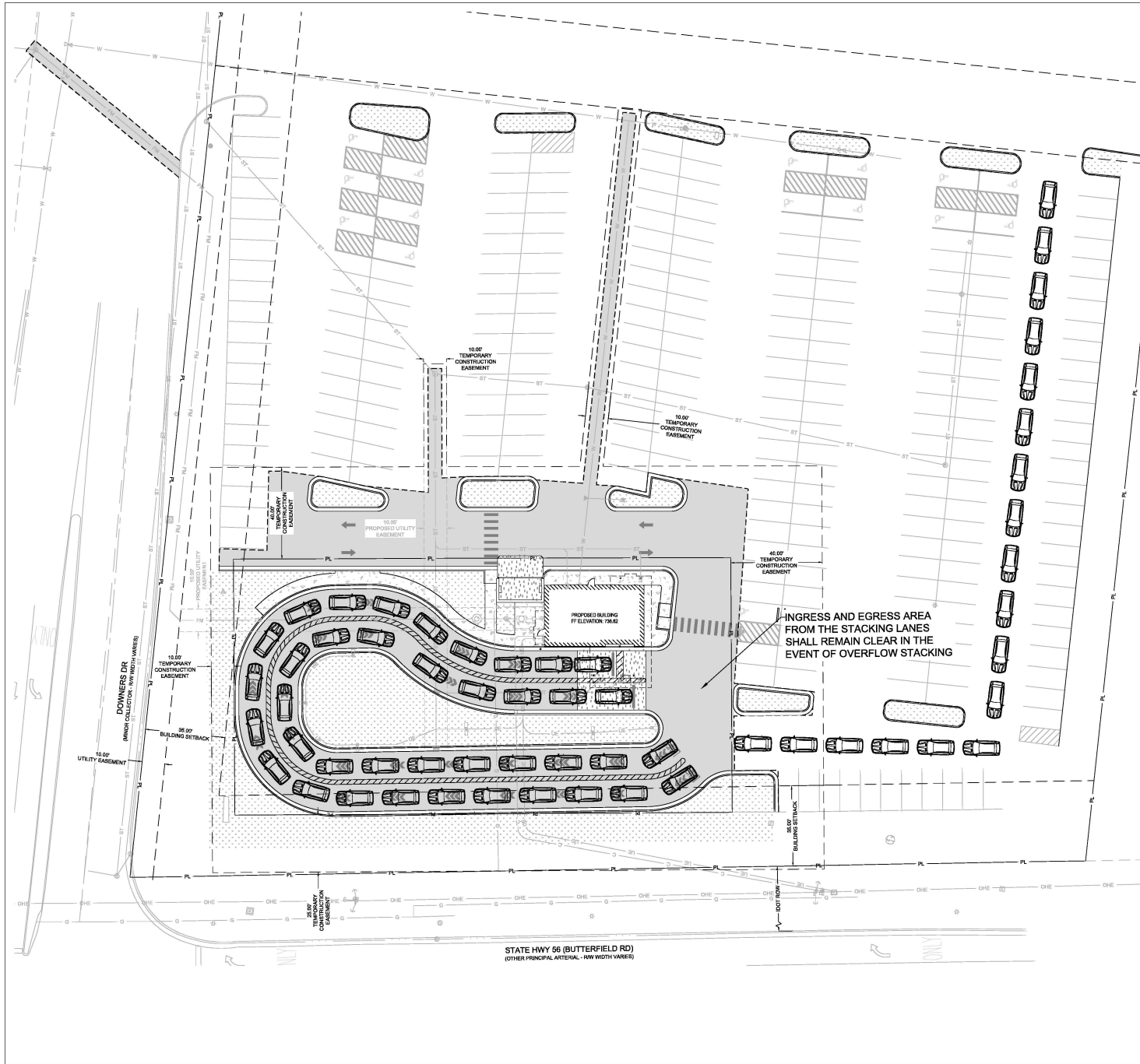

- HATCH LEGEND:**
- ASPHALT PAVEMENT
 - CONCRETE SIDEWALK
 - CONCRETE PAVEMENT
 - LANDSCAPE AREA

PARKING:
PROVIDED: 7 STALLS, 8 STANDARD AND 1 ADA.

DRIVE-THRU QUEUE STACKING:
STACKING PROVIDED IN LANE 1 AND 2 - 30 VEHICLES

-OFF SITE STACKING SHALL BEGIN EAST OF THE LANE ENTRANCE AND RUN ALONG THE NORTHEAST DRIVE PARKING LANE. STACKING SHALL NOT IMPED THE INGRESS AND EGRESS AREA FROM THE STACKING LANES.

INGRESS AND EGRESS AREA FROM THE STACKING LANES SHALL REMAIN CLEAR IN THE EVENT OF OVERFLOW STACKING

STATE HWY 56 (BUTTERFIELD RD)
(OTHER PRINCIPAL ARTERIAL - NW WIDTH VARIES)



H. SCALE: 1" = 20'



TOOTH & ASSOCIATES
1591 E. REPUBLIC ROAD
SPRINGFIELD, ILLINOIS
PH: 417-855-0545 Fax: 417-855-0527
www.toothandassociates.com
E.P. 63920661
© 2025 Toth and Associates, Inc.



ENGINEER OF RECORD:
NAME: MATTHEW STEVEN MILLER
LICENSE NO. E. #PE 042 063164
EXP. 11/30/2027

PROJECT NUMBER:
104508

REVISION:

7 BREW COFFEE
DOWNERS GROVE, IL 02
1434 BUTTERFIELD RD
DOWNERS GROVE, IL 60515

C2.2
STACKING PLAN

DATE: DECEMBER 9TH, 2025

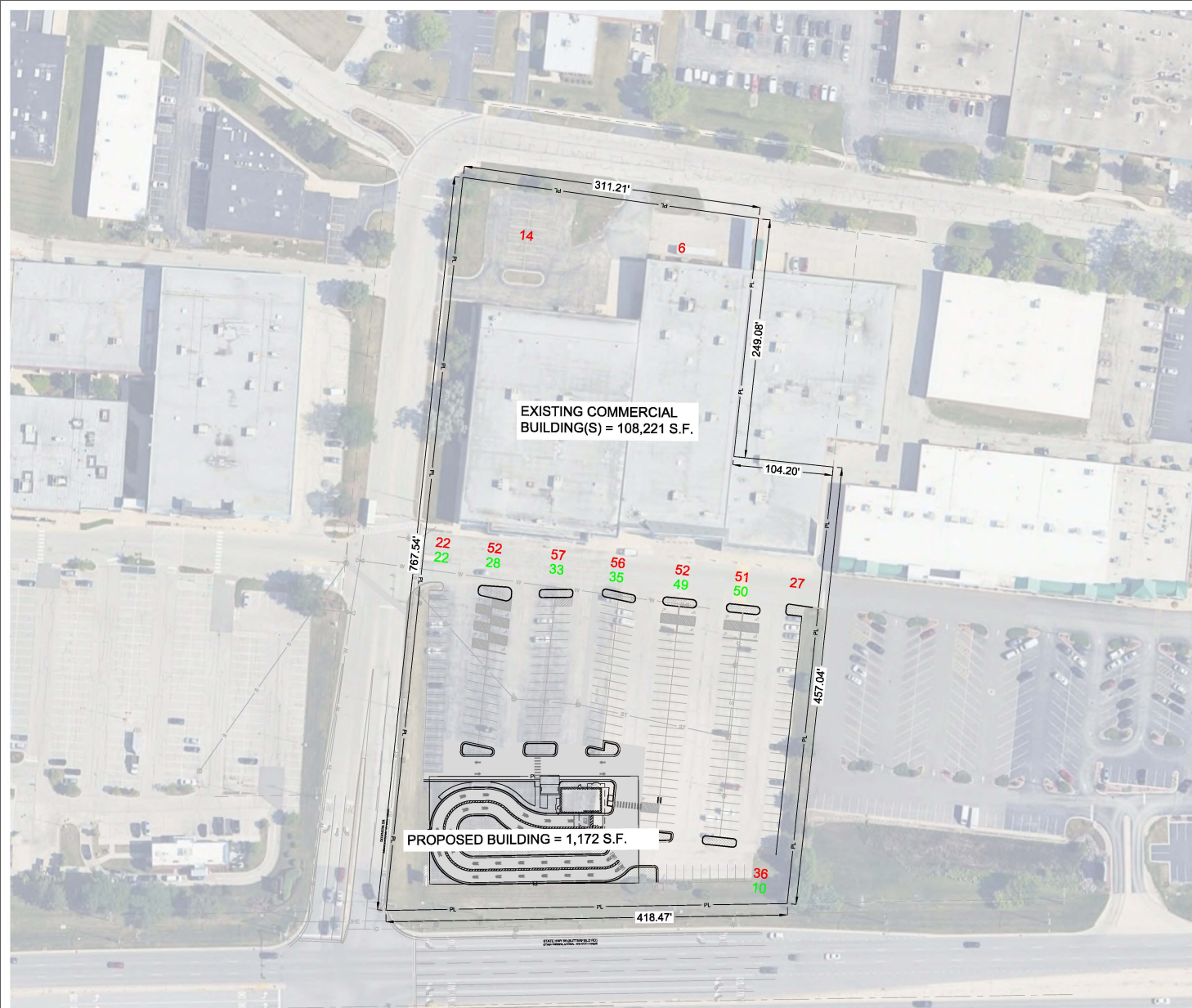

HATCH LEGEND:
 [Hatched Box] = ASPHALT PAVEMENT
 [Dotted Box] = LANDSCAPE AREA

LEGEND:
 EXISTING PARKING IN RED
 PROPOSED PARKING IN GREEN



ENGINEER OF RECORD:
 NAME: MATTHEW STEVEN MILLER
 LICENSE NO.: E. #PE 062 06164
 EXP. 11/30/2027

PROJECT NUMBER:
 10458
 REVISION:

7 BREW COFFEE
DOWNERS GROVE, IL 02
 1434 BUTTERFIELD RD
 DOWNERS GROVE, IL 60515

C2.3
 PARKING LOT EXHIBIT

DATE: DECEMBER 9TH, 2025





- KEY NOTES:**
- ① MATCH EXISTING ELEVATION
 - ② HIGH POINT IN ASSEMBLY
 - ③ CENTRAL POINT OF GRADE IN ASSEMBLY



7 B C&A
 CONSULTING ENGINEERS
 1434 BUTTERFIELD RD
 DOWNERS GROVE, IL 60515
 WWW.7BANDCA.COM

ATOTH
 & ASSOCIATES
 1434 BUTTERFIELD RD
 DOWNERS GROVE, IL 60515
 TEL: 630.583.8800
 FAX: 630.583.8807
 WWW.ATOTH.COM

C3.1
 GRADING PLAN
 04/11/2025 09:55

**7 BREW COFFEE
 DOWNERS GROVE, IL 02**

1434 BUTTERFIELD RD
 DOWNERS GROVE, IL 60515

ENGINEER OF RECORD:
 NAME: JAMES SHERMILLER
 LICENSE NO. R-011202404
 B.S.P. 1/10/2022

PROJECT NUMBER:
 143402

REVISION:



- ABBREVIATIONS:**
- RES FILL
 - FLASD END SECTION
 - CON
 - CONCRETE
 - ASPH
 - INVERT
 - RIGHT-OF-WAY
 - TC
 - TOP OF CURB
 - TOP OF GROUND
 - TOP OF FINISHED
 - TOP OF WALL
 - BTM OF WALL
 - EXIST
 - EXISTING TOP OF CURB
 - EXISTING TOP OF FINISHED
 - EXISTING TOP OF SIDEWALK
 - EXIST
 - DIRECTION OF SHEET FLOW

NOTES:
 1. ALL ELEVATIONS ARE IN FEET AND DECIMALS THEREOF.
 2. ALL SPOT HEIGHTS ARE TO BE CHECKED AND REVERSED FOR SIGHTING NUMBER OF TUBES.
 3. ALL SPOT HEIGHTS ARE TO BE CHECKED AND REVERSED FOR SIGHTING NUMBER OF TUBES.



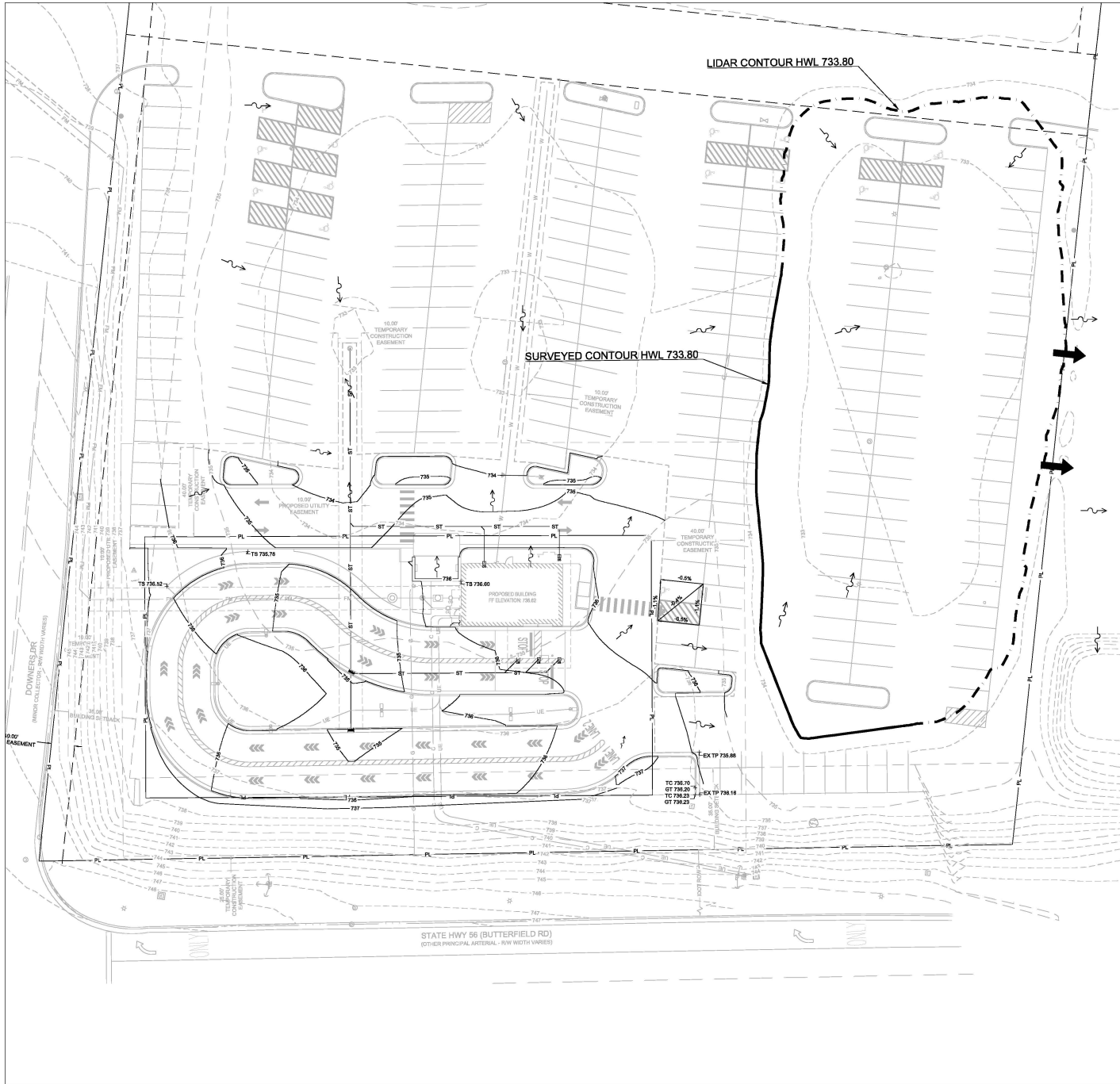

ABBREVIATIONS:

FES	FLARED END SECTION
FL	FLOW LINE
GT	GUTTER
INV	INVERT
R/W	RIGHT-OF-WAY
SC	SPILL CURB
TC	TOP OF CURB
TG	TOP OF GROUND
TP	TOP OF PAVEMENT
TS	TOP OF SIDEWALK
TW	TOP OF WALL
BW	BOTTOM OF WALL
EX TC	EXISTING TOP OF CURB
EX TP	EXISTING TOP OF PAVEMENT
EX TS	EXISTING TOP OF SIDEWALK
→	DIRECTION OF SHEET FLOW
→	100-YEAR OVERFLOW ARROW

NOTES:
 AREAS TO BE GRADED AND PREPARED FOR SEEDING OR SOI SHALL INDICATE A MINIMUM OF FOUR (4) INCHES OF TOPSOIL.



ENGINEER OF RECORD:
 NAME: MATTHEW STEVEN MILLER
 LICENSE NO. E. #062 063164
 EXP. 11/30/2027

PROJECT NUMBER:
 10458

REVISION:

7 BREW COFFEE
DOWNERS GROVE, IL 02
 1434 BUTTERFIELD RD
 DOWNERS GROVE, IL 60515



TO TH & ASSOCIATES
 1501 E. REPUBLIC ROAD
 SPRINGFIELD, ILLINOIS
 PH: 417-853-0643 Fax: 417-853-0657
 www.tothinc.com
 ELP 6302661
 © 2025 To Th & Associates, Inc.

C3.2
 EMERGENCY OVERFLOW ROUTE
 DATE: DECEMBER 9TH, 2025



HATCH LEGEND

- PLANT GRASS 500 - 1/4" @ 87 PERCENTAL, P/1/4 - 8/8" SHEET
- PLANT GRASS 1000 - 1/4" @ 17 PERCENTAL, P/1/4 - 8/8" SHEET
- PLANT GRASS 2000 - 1/4" @ 34 PERCENTAL, P/1/4 - 8/8" SHEET
- PLANT GRASS 4000 - 1/4" @ 68 PERCENTAL, P/1/4 - 8/8" SHEET
- PLANT GRASS 8000 - 1/4" @ 136 PERCENTAL, P/1/4 - 8/8" SHEET
- PLANT GRASS 16000 - 1/4" @ 272 PERCENTAL, P/1/4 - 8/8" SHEET
- PLANT GRASS 32000 - 1/4" @ 544 PERCENTAL, P/1/4 - 8/8" SHEET
- PLANT GRASS 64000 - 1/4" @ 1088 PERCENTAL, P/1/4 - 8/8" SHEET
- PLANT GRASS 128000 - 1/4" @ 2176 PERCENTAL, P/1/4 - 8/8" SHEET
- PLANT GRASS 256000 - 1/4" @ 4352 PERCENTAL, P/1/4 - 8/8" SHEET
- PLANT GRASS 512000 - 1/4" @ 8704 PERCENTAL, P/1/4 - 8/8" SHEET
- PLANT GRASS 1024000 - 1/4" @ 17408 PERCENTAL, P/1/4 - 8/8" SHEET
- PLANT GRASS 2048000 - 1/4" @ 34816 PERCENTAL, P/1/4 - 8/8" SHEET
- PLANT GRASS 4096000 - 1/4" @ 69632 PERCENTAL, P/1/4 - 8/8" SHEET
- PLANT GRASS 8192000 - 1/4" @ 139264 PERCENTAL, P/1/4 - 8/8" SHEET
- PLANT GRASS 16384000 - 1/4" @ 278528 PERCENTAL, P/1/4 - 8/8" SHEET
- PLANT GRASS 32768000 - 1/4" @ 557056 PERCENTAL, P/1/4 - 8/8" SHEET
- PLANT GRASS 65536000 - 1/4" @ 1114112 PERCENTAL, P/1/4 - 8/8" SHEET
- PLANT GRASS 131072000 - 1/4" @ 2228224 PERCENTAL, P/1/4 - 8/8" SHEET
- PLANT GRASS 262144000 - 1/4" @ 4456448 PERCENTAL, P/1/4 - 8/8" SHEET
- PLANT GRASS 524288000 - 1/4" @ 8912896 PERCENTAL, P/1/4 - 8/8" SHEET
- PLANT GRASS 1048576000 - 1/4" @ 17825792 PERCENTAL, P/1/4 - 8/8" SHEET
- PLANT GRASS 2097152000 - 1/4" @ 35651584 PERCENTAL, P/1/4 - 8/8" SHEET
- PLANT GRASS 4194304000 - 1/4" @ 71303168 PERCENTAL, P/1/4 - 8/8" SHEET
- PLANT GRASS 8388608000 - 1/4" @ 142606336 PERCENTAL, P/1/4 - 8/8" SHEET
- PLANT GRASS 16777216000 - 1/4" @ 285212672 PERCENTAL, P/1/4 - 8/8" SHEET
- PLANT GRASS 33554432000 - 1/4" @ 570425344 PERCENTAL, P/1/4 - 8/8" SHEET
- PLANT GRASS 67108864000 - 1/4" @ 1140850688 PERCENTAL, P/1/4 - 8/8" SHEET
- PLANT GRASS 134217728000 - 1/4" @ 2281701376 PERCENTAL, P/1/4 - 8/8" SHEET
- PLANT GRASS 268435456000 - 1/4" @ 4563402752 PERCENTAL, P/1/4 - 8/8" SHEET
- PLANT GRASS 536870912000 - 1/4" @ 9126805504 PERCENTAL, P/1/4 - 8/8" SHEET
- PLANT GRASS 1073741824000 - 1/4" @ 18253611008 PERCENTAL, P/1/4 - 8/8" SHEET
- PLANT GRASS 2147483648000 - 1/4" @ 36507222016 PERCENTAL, P/1/4 - 8/8" SHEET
- PLANT GRASS 4294967296000 - 1/4" @ 73014444032 PERCENTAL, P/1/4 - 8/8" SHEET
- PLANT GRASS 8589934592000 - 1/4" @ 146028888064 PERCENTAL, P/1/4 - 8/8" SHEET
- PLANT GRASS 17179869184000 - 1/4" @ 292057776128 PERCENTAL, P/1/4 - 8/8" SHEET
- PLANT GRASS 34359738368000 - 1/4" @ 584115552256 PERCENTAL, P/1/4 - 8/8" SHEET
- PLANT GRASS 68719476736000 - 1/4" @ 1168231104512 PERCENTAL, P/1/4 - 8/8" SHEET
- PLANT GRASS 137438953472000 - 1/4" @ 2336462209024 PERCENTAL, P/1/4 - 8/8" SHEET
- PLANT GRASS 274877906944000 - 1/4" @ 4672924418048 PERCENTAL, P/1/4 - 8/8" SHEET
- PLANT GRASS 549755813888000 - 1/4" @ 9345848836096 PERCENTAL, P/1/4 - 8/8" SHEET
- PLANT GRASS 1099511627776000 - 1/4" @ 18691697672192 PERCENTAL, P/1/4 - 8/8" SHEET
- PLANT GRASS 2199023255552000 - 1/4" @ 37383395344384 PERCENTAL, P/1/4 - 8/8" SHEET
- PLANT GRASS 4398046511104000 - 1/4" @ 74766790688768 PERCENTAL, P/1/4 - 8/8" SHEET
- PLANT GRASS 8796093022208000 - 1/4" @ 149533581377536 PERCENTAL, P/1/4 - 8/8" SHEET
- PLANT GRASS 17592186044416000 - 1/4" @ 299067162755072 PERCENTAL, P/1/4 - 8/8" SHEET
- PLANT GRASS 35184372088832000 - 1/4" @ 598134325510144 PERCENTAL, P/1/4 - 8/8" SHEET
- PLANT GRASS 70368744177664000 - 1/4" @ 1196268651020288 PERCENTAL, P/1/4 - 8/8" SHEET
- PLANT GRASS 140737488355328000 - 1/4" @ 2392537302040576 PERCENTAL, P/1/4 - 8/8" SHEET
- PLANT GRASS 281474976710656000 - 1/4" @ 4785074604081152 PERCENTAL, P/1/4 - 8/8" SHEET
- PLANT GRASS 562949953421312000 - 1/4" @ 9570149208162304 PERCENTAL, P/1/4 - 8/8" SHEET
- PLANT GRASS 1125899906842624000 - 1/4" @ 19140298416324608 PERCENTAL, P/1/4 - 8/8" SHEET
- PLANT GRASS 2251799813685248000 - 1/4" @ 38280596832649216 PERCENTAL, P/1/4 - 8/8" SHEET
- PLANT GRASS 4503599627370496000 - 1/4" @ 76561193665298432 PERCENTAL, P/1/4 - 8/8" SHEET
- PLANT GRASS 9007199254740992000 - 1/4" @ 153122387330596864 PERCENTAL, P/1/4 - 8/8" SHEET
- PLANT GRASS 18014398509481984000 - 1/4" @ 306244774661193728 PERCENTAL, P/1/4 - 8/8" SHEET
- PLANT GRASS 36028797018963968000 - 1/4" @ 612489549322387456 PERCENTAL, P/1/4 - 8/8" SHEET
- PLANT GRASS 72057594037927936000 - 1/4" @ 1224979098644774912 PERCENTAL, P/1/4 - 8/8" SHEET
- PLANT GRASS 144115188075855872000 - 1/4" @ 2449958197289549824 PERCENTAL, P/1/4 - 8/8" SHEET
- PLANT GRASS 288230376151711744000 - 1/4" @ 4899916394579099648 PERCENTAL, P/1/4 - 8/8" SHEET
- PLANT GRASS 576460752303423488000 - 1/4" @ 9799832789158199296 PERCENTAL, P/1/4 - 8/8" SHEET
- PLANT GRASS 1152921504606846976000 - 1/4" @ 19599665578316398592 PERCENTAL, P/1/4 - 8/8" SHEET
- PLANT GRASS 2305843009213693952000 - 1/4" @ 39199331156632797184 PERCENTAL, P/1/4 - 8/8" SHEET
- PLANT GRASS 4611686018427387904000 - 1/4" @ 78398662313265594368 PERCENTAL, P/1/4 - 8/8" SHEET
- PLANT GRASS 9223372036854775808000 - 1/4" @ 156797324626531188736 PERCENTAL, P/1/4 - 8/8" SHEET
- PLANT GRASS 18446744073709551616000 - 1/4" @ 313594649253062377472 PERCENTAL, P/1/4 - 8/8" SHEET
- PLANT GRASS 36893488147419103232000 - 1/4" @ 627189298506124754944 PERCENTAL, P/1/4 - 8/8" SHEET
- PLANT GRASS 73786976294838206464000 - 1/4" @ 1254378597012249509888 PERCENTAL, P/1/4 - 8/8" SHEET
- PLANT GRASS 147573952589676412928000 - 1/4" @ 2508757194024499019776 PERCENTAL, P/1/4 - 8/8" SHEET
- PLANT GRASS 295147905179352825856000 - 1/4" @ 5017514388048998039552 PERCENTAL, P/1/4 - 8/8" SHEET
- PLANT GRASS 5902958103587056517056000 - 1/4" @ 10035028776097996079104 PERCENTAL, P/1/4 - 8/8" SHEET
- PLANT GRASS 11805916207174113034112000 - 1/4" @ 20070057552195992158208 PERCENTAL, P/1/4 - 8/8" SHEET
- PLANT GRASS 23611832414348226068224000 - 1/4" @ 40140115104391984316416 PERCENTAL, P/1/4 - 8/8" SHEET
- PLANT GRASS 47223664828696452136448000 - 1/4" @ 80280230208783968632832 PERCENTAL, P/1/4 - 8/8" SHEET
- PLANT GRASS 94447329657392904272896000 - 1/4" @ 160560460417567937265664 PERCENTAL, P/1/4 - 8/8" SHEET
- PLANT GRASS 188894659314785808545792000 - 1/4" @ 321120920835135874531328 PERCENTAL, P/1/4 - 8/8" SHEET
- PLANT GRASS 377789318629571617091584000 - 1/4" @ 642241841670271749062656 PERCENTAL, P/1/4 - 8/8" SHEET
- PLANT GRASS 755578637259143234183168000 - 1/4" @ 1284483683340543498125312 PERCENTAL, P/1/4 - 8/8" SHEET
- PLANT GRASS 1511157274518286468366336000 - 1/4" @ 2568967366681086996250624 PERCENTAL, P/1/4 - 8/8" SHEET
- PLANT GRASS 3022314549036572936732672000 - 1/4" @ 5137934733362173992501248 PERCENTAL, P/1/4 - 8/8" SHEET
- PLANT GRASS 6044629098073145873465344000 - 1/4" @ 10275869466724347985002496 PERCENTAL, P/1/4 - 8/8" SHEET
- PLANT GRASS 12089258196146291746930688000 - 1/4" @ 20551738933448695970004992 PERCENTAL, P/1/4 - 8/8" SHEET
- PLANT GRASS 24178516392292583493861376000 - 1/4" @ 41103477866897391940009984 PERCENTAL, P/1/4 - 8/8" SHEET
- PLANT GRASS 48357032784585166987722752000 - 1/4" @ 82206955733794783880019968 PERCENTAL, P/1/4 - 8/8" SHEET
- PLANT GRASS 96714065569170333975445504000 - 1/4" @ 164413911467589567760039936 PERCENTAL, P/1/4 - 8/8" SHEET
- PLANT GRASS 193428131138340667910891008000 - 1/4" @ 328827822935179135520079872 PERCENTAL, P/1/4 - 8/8" SHEET
- PLANT GRASS 386856262276681335821782016000 - 1/4" @ 657655645870358271040159744 PERCENTAL, P/1/4 - 8/8" SHEET
- PLANT GRASS 773712524553362671643564032000 - 1/4" @ 1315311291740716542080319488 PERCENTAL, P/1/4 - 8/8" SHEET
- PLANT GRASS 1547425049106725343287128064000 - 1/4" @ 2630622583481433084160638976 PERCENTAL, P/1/4 - 8/8" SHEET
- PLANT GRASS 3094850098213450686574256128000 - 1/4" @ 5261245166962866168321277952 PERCENTAL, P/1/4 - 8/8" SHEET
- PLANT GRASS 6189700196426901373148512256000 - 1/4" @ 10522490333925732336642555904 PERCENTAL, P/1/4 - 8/8" SHEET
- PLANT GRASS 12379400392853802746297024512000 - 1/4" @ 21044980667851464673285111808 PERCENTAL, P/1/4 - 8/8" SHEET
- PLANT GRASS 24758800785707605492594049024000 - 1/4" @ 42089961335702929346570223616 PERCENTAL, P/1/4 - 8/8" SHEET
- PLANT GRASS 49517601571415210985188988048000 - 1/4" @ 84179922671405858693140447232 PERCENTAL, P/1/4 - 8/8" SHEET
- PLANT GRASS 99035203142830421970377976096000 - 1/4" @ 168359853428811717386280894464 PERCENTAL, P/1/4 - 8/8" SHEET
- PLANT GRASS 198070406285660843940755952192000 - 1/4" @ 336719706857623434772561789128 PERCENTAL, P/1/4 - 8/8" SHEET
- PLANT GRASS 396140812571321687881511904384000 - 1/4" @ 673439413715246869545123578256 PERCENTAL, P/1/4 - 8/8" SHEET
- PLANT GRASS 792281625142643375763023808768000 - 1/4" @ 1346878827430493739090247156512 PERCENTAL, P/1/4 - 8/8" SHEET
- PLANT GRASS 1584563250285286751526047617136000 - 1/4" @ 2693757654860987478180494313024 PERCENTAL, P/1/4 - 8/8" SHEET
- PLANT GRASS 3169126500570573503052095234272000 - 1/4" @ 5387515309721974956360988626048 PERCENTAL, P/1/4 - 8/8" SHEET
- PLANT GRASS 6338253001141147006104190468544000 - 1/4" @ 10775030619443949912721977252096 PERCENTAL, P/1/4 - 8/8" SHEET
- PLANT GRASS 12676506002282294012208238937088000 - 1/4" @ 21550061238887899825443954504192 PERCENTAL, P/1/4 - 8/8" SHEET
- PLANT GRASS 25353012004564588024416477874176000 - 1/4" @ 43100122477775799650887909008384 PERCENTAL, P/1/4 - 8/8" SHEET
- PLANT GRASS 50706024009129176048832955748352000 - 1/4" @ 86200244955551599301775818016768 PERCENTAL, P/1/4 - 8/8" SHEET
- PLANT GRASS 101412048018258352097665911496704000 - 1/4" @ 172400489911103198603551636033536 PERCENTAL, P/1/4 - 8/8" SHEET
- PLANT GRASS 202824096036516704195331822993408000 - 1/4" @ 344800979822206397207103272067072 PERCENTAL, P/1/4 - 8/8" SHEET
- PLANT GRASS 405648192073033408390663645986816000 - 1/4" @ 689601959644412794414206544134144 PERCENTAL, P/1/4 - 8/8" SHEET
- PLANT GRASS 811296384146066816781327291973632000 - 1/4" @ 1379203919288825588828413082668288 PERCENTAL, P/1/4 - 8/8" SHEET
- PLANT GRASS 1622592768292133635642655843947264000 - 1/4" @ 2758407838577651177656826165336576 PERCENTAL, P/1/4 - 8/8" SHEET
- PLANT GRASS 3245185536584267271285311687894552000 - 1/4" @ 5516815677155302355313652330673152 PERCENTAL, P/1/4 - 8/8" SHEET
- PLANT GRASS 6490371073168534542570623375789104000 - 1/4" @ 11033631354310604710627304661346304 PERCENTAL, P/1/4 - 8/8" SHEET
- PLANT GRASS 1298074214633706908514124675578208000 - 1/4" @ 22067262708621209421254609322692608 PERCENTAL, P/1/4 - 8/8" SHEET
- PLANT GRASS 2596148429267413817028249351156416000 - 1/4" @ 44134525417242418842509218645385216 PERCENTAL, P/1/4 - 8/8" SHEET
- PLANT GRASS 5192296858534827634056498702312832000 - 1/4" @ 88269050834484837685018437290770432 PERCENTAL, P/1/4 - 8/8" SHEET
- PLANT GRASS 10384593717069655268112976446256064000 - 1/4" @ 176538101668969675370036874581540864 PERCENTAL, P/1/4 - 8/8" SHEET
- PLANT GRASS 20769187434139310536225952892512128000 - 1/4" @ 353076203337939350740073749163081728 PERCENTAL, P/1/4 - 8/8" SHEET
- PLANT GRASS 41538374868278621072451905785024352000 - 1/4" @ 706152406675878701480147498326163456 PERCENTAL, P/1/4 - 8/8" SHEET
- PLANT GRASS 830767497365572421449038115700486848000 - 1/4" @ 1412304813351757402960294996652327104 PERCENTAL, P/1/4 - 8/8" SHEET
- PLANT GRASS 166153499473114484289807631400973696000 - 1/4" @ 2824609626703514805920589993304654208 PERCENTAL, P/1/4 - 8/8" SHEET
- PLANT GRASS 332306998946228968579615262801947136000 - 1/4" @ 5649219253407029611841179986609308416 PERCENTAL, P/1/4 - 8/8" SHEET
- PLANT GRASS 664613997892457937159230525603894272000 - 1/4" @ 11298438506814059223682359973218616832 PERCENTAL, P/1/4 - 8/8" SHEET
- PLANT GRASS 132922799578491587431846105120772352000 - 1/4" @ 22596877013628118447364719946437233664 PERCENTAL, P/1/4 - 8/8" SHEET
- PLANT GRASS 2658455991569831748636922102414466736000 - 1/4" @ 45193754027256236894729439892874467328 PERCENTAL, P/1/4 - 8/8" SHEET
- PLANT GRASS 531691198313966349727384420482893472000 - 1/4" @ 90387508054512473789458879785748934656 PERCENTAL, P/1/4 - 8/8" SHEET
- PLANT GRASS 106338239662793269945476884095787872000 - 1/4" @ 180775016109024947578917759571497869312 PERCENTAL, P/1/4 - 8/8" SHEET
- PLANT GRASS 212676479325586539890953768191575744000 - 1/4" @ 361550032218049895157835519142995738624 PERCENTAL, P/1/4 - 8/8" SHEET
- PLANT GRASS 4253529586511730797819075363831514784000 - 1/4" @ 723100064436099790315671038285991473248 PERCENTAL, P/1/4 - 8/8" SHEET
- PLANT GRASS 85070591730234615956381507276630294688000 - 1/4" @ 1446200128872199580631342076571922946496 PERCENTAL, P/1/4 - 8/8" SHEET
- PLANT GRASS 170141183460469231912763014553260589376000 - 1/4" @ 2892400257744399161262684153143845892992 PERCENTAL, P/1/4 - 8/8" SHEET
- PLANT GRASS 340282366920938463825526029106521178752000 - 1/4" @ 5784800515488798322525368306287691785984 PERCENTAL, P/1/4 - 8/8" SHEET
- PLANT GRASS 680564733841876927651052058213042357504000 - 1/4" @ 11569601030977596645050736612573833711968 PERCENTAL, P/1/4 - 8/8" SHEET
- PLANT GRASS 1361129467683753855302104116426047155008000 - 1/4" @ 23139202061955193290101473225147667423936 PERCENTAL, P/1/4 - 8/8" SHEET
- PLANT GRASS 272225893536750771060420823285209430016000 - 1/4" @ 46278404123910386580202946450295348477824 PERCENTAL, P/1/4 - 8/8" SHEET
- PLANT GRASS 544451787073501542120841646570418860032000 - 1/4" @ 92556808247820773160405892900590696955648 PERCENTAL, P/1/4 - 8/8" SHEET
- PLANT GRASS 1088903574147003084241683293140837730112000 - 1/4" @ 18511361649564154632081178580118139311296 PERCENTAL, P/1/4 - 8/8" SHEET
- PLANT GRASS 2177807148294006168483366586281675460224000 - 1/4" @ 37022723299128309264162357160236278622592 PERCENTAL, P/1/4 - 8/8" SHEET
- PLANT GRASS 4355614296588012336966733172563350920448000 - 1/4" @ 74045446598256618528324714320472557245184 PERCENTAL, P/1/4 - 8/8" SHEET
- PLANT GRASS 8711228593176024673933466345126701840896000 - 1/4"

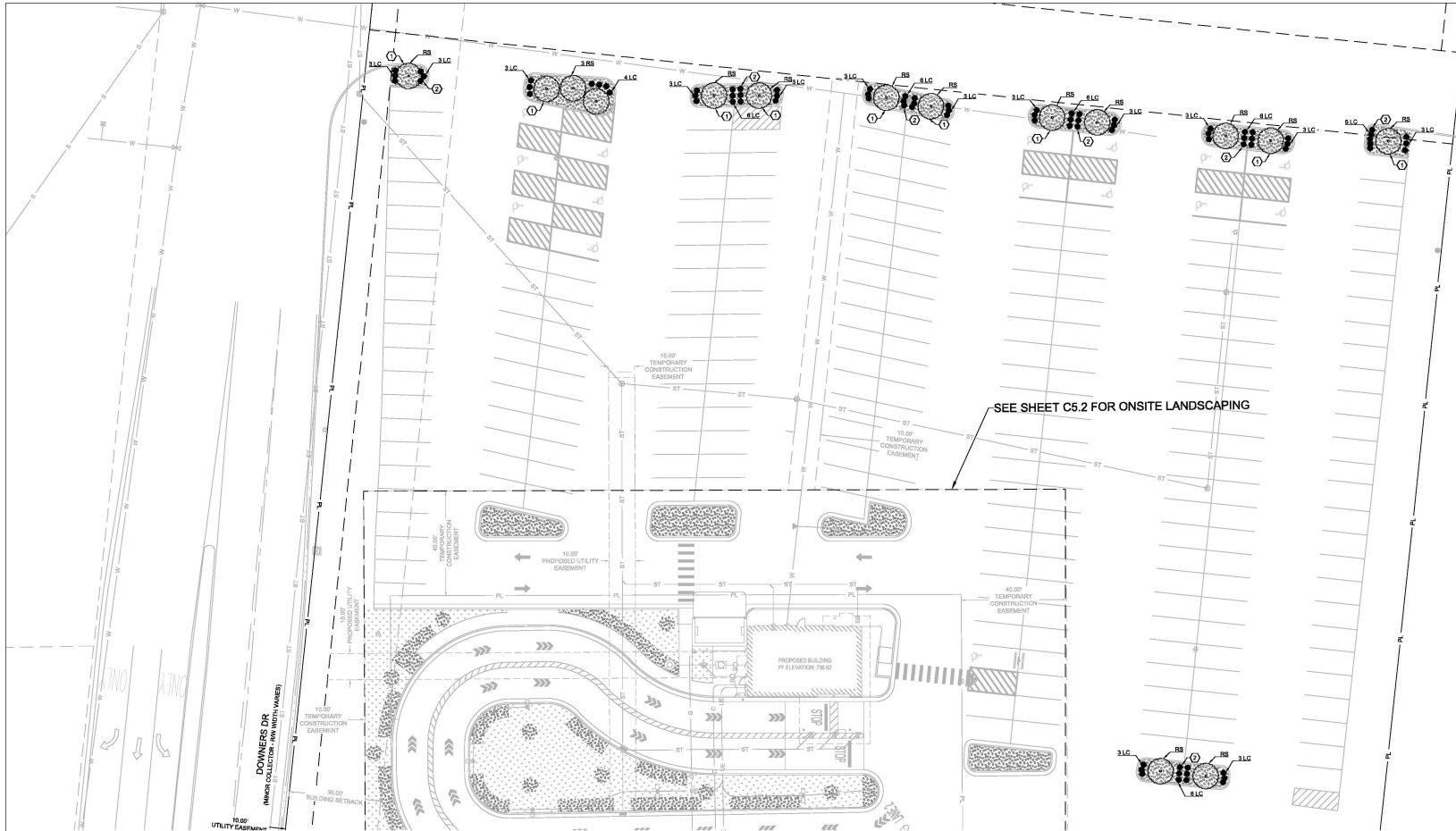

HATCH LEGEND:

LANDSCAPE MULCH = 1,368 S.F.
 (SMOOTH) SOIL SHALL BE COVERED BY WELDED FABRIC AND TOPPED WITH 3 TO 4-INCH LAYER OF 8-BREDED HARDWOOD MULCH.

KEY NOTES:

- ① TREES TO BE PLANTED ACCORDING TO TREE PLANTING DETAIL 6 C2, SHEET C7.2.
- ② SHRUBS TO BE PLANTED ACCORDING TO TREE PLANTING DETAIL 6 C2, SHEET C7.2.

LANDSCAPE ISLANDS (SEC 28.8.020):

1 SHADE TREE EVERY 150 S.F. OF LANDSCAPE ISLAND ROUNDED TO THE NEAREST WHOLE.

- 154 S.F. / 100 S.F. = 1 SHADE TREES
- 344 S.F. / 100 S.F. = 3 SHADE TREES
- 288 S.F. / 100 S.F. = 2 SHADE TREES
- 243 S.F. / 100 S.F. = 2 SHADE TREES
- 288 S.F. / 100 S.F. = 2 SHADE TREES
- 174 S.F. / 100 S.F. = 1 SHADE TREES
- 275 S.F. / 100 S.F. = 2 SHADE TREES

50% MUST BE LANDSCAPED WITH LIVE MATERIAL
 PROVIDED SHRUBS = 81

PLANTING LIST

TYPE	COMMON NAME (SCIENTIFIC NAME)	QUANTITY REQUIRED	QUANTITY PROVIDED	CONDITION AND SIZE	APPROXIMATE MATURE SIZE
SHADE TREES					
RS	RED SUNSET MAPLE (ACER RUBRUM)	15	15	2.5" CAL. DBH	9' T x 8' SP
SHRUBS					
LC	LOW SCAPE MOUND CHOCHEBERRY (ARONIA M. UCCONNIAE)	81	81	18" HRL	2'X2'



ENGINEER OF RECORD:
 NAME: MATTHEW STEVEN MILLER
 LICENSE NO. E. PPE 062 063164
 EXP. 11/30/2027
PROJECT NUMBER:
 10458
REVISION:

7 BREW COFFEE
DOWNERS GROVE, IL 02
 1434 BUTTERFIELD RD
 DOWNERS GROVE, IL 60515

C5.3

OFFSITE LANDSCAPE PLAN
 DATE: DECEMBER 9TH, 2025





LUMINAIRE LOCATION SUMMARY		
LUM NO.	LABEL	MTG. HT.
1	B2	20
2	B2	20
3-6	B3	20
7-32	D	8.5
33	SB	15.76
34	SB	15.9
35	SB	16.055
36	SB	16.197
37	SB	16.336
38	SB	16.46
39	SB	16.584
40	SB	16.709
41	SB	16.831
42	SB	16.958
43	SB	17.083
44	SB	17.197
45	SB	17.297
46	SB	17.408
47	SB	17.504
48	SB	17.606
49	SB	17.7
50	SB	17.781
51	SB	17.87
52	SB	17.932
53	SB	18.01
54	SB	18.096
55	SB	18.149
56	SB	18.2
57	SB	18.297
58	SB	18.346
59	SB	18.397
60	SB	18.459
61	SB	18.506
62	SB	18.522
63	SB	18.553
64	SB	18.568
65	SB	18.599
66	SB	18.6
67	SB	18.614
68	SB	18.63
69	SB	18.646
70	SB	18.660
71	SB	18.666
72	SB	18.685
73	SB	18.645
74	SB	18.627
75	SB	18.607
76	SB	18.584
77	SB	18.552

LUMINAIRE LOCATION SUMMARY		
LUM NO.	LABEL	MTG. HT.
78	SB	18.537
79	SB	18.49
80	SB	18.444
81	SB	18.397
82	SB	18.351
83	SB	18.32
84	SB	18.273
85	SB	18.212
86	SB	18.241
87	SB	18.69
88	SB	14.882
89	SB	15.76
90	SB	15.9
91	SB	15.024
92	SB	15.17
93	SB	15.313
94	SB	15.462
95	SB	15.618
96	SB	16.055
97	SB	16.197
98	SB	16.336
99	SB	16.46
100	SB	16.584
101	SB	16.709
102	SB	16.831
103	SB	16.958
104	SB	17.083
105	SB	17.197
106	SB	17.297
107	SB	17.408
108	SB	17.504
109	SB	17.606
110	SB	17.7
111	SB	17.781
112	SB	17.87
113	SB	17.932
114	SB	18.01
115	SB	18.149
116	SB	18.096
117	SB	18.2
118	SB	18.297
119	SB	18.346
120	SB	18.397
121	SB	18.434
122	SB	18.459
123	SB	18.506
124	SB	18.522
125	SB	18.553
126	SB	18.599

LUMINAIRE LOCATION SUMMARY		
LUM NO.	LABEL	MTG. HT.
127	SB	18.568
128	SB	18.6
129	SB	18.614
130	SB	18.63
131	SB	18.646
132	SB	18.646
133	SB	18.646
134	SB	18.665
135	SB	18.646
136	SB	18.627
137	SB	18.607
138	SB	18.584
139	SB	18.552
140	SB	18.537
141	SB	18.49
142	SB	18.444
143	SB	18.397
144	SB	18.351
145	SB	18.32
146	SB	18.273
147	SB	18.212
148	SB	18.69
149	SB	14.882
150	SB	15.024
151	SB	15.17
152	SB	15.313
153	SB	15.462
154	SB	15.618
155	SB04	18.2
156	SB04	14.23
157	SB12	18.2
158	SB12	14.23
159-165	SF	9.5
166	SF02	9.5
167	SF02	9.5
168	SF02	9.5
169	SF04	9.5
170	SF04	9.5
171-178	SF12	9.5
179	WP	8.5

NOTES:
 - POLE MOUNTED FIXTURES ARE MOUNTED ON A 20FT POLE ON CONCRETE BASE AT GRADE
 THIS SITE IS LOCATED IN A REGION WHERE LIGHTING IS REGULATED BY LOCAL ORDINANCE

FOOTCANDLES LEVELS CALCULATED AT GRADE USING INITIAL LUMEN VALUES					
LABEL	AVG	MAX	MIN	AVG/MIN	MAX/MIN
PAVED AREA	2.32	5.6	0.3	11.80	28.00
PROPERTY LINE	0.36	1.1	0.0	N.A.	N.A.
UNDEFINED UNDERCANOPY	0.99	11.2	0.0	N.A.	N.A.
UNDERCANOPY	22.36	35	12	1.86	2.92

LUMINAIRE SCHEDULE										
SYMBOL	QTY	LABEL	ARRANGEMENT	LUMENS	LLF	BUG Rating	ARR. WATTS	TOTAL WATTS	MANUFACTURE	DESCRIPTION
[Symbol]	2	B2	Back-Back	7189	1.030	B1-U0-G2	102.68	205.36	Lithonia Lighting	RSX1 LED P1 40K R4
[Symbol]	4	B3	Single	7189	1.030	B1-U0-G2	51.34	Lithonia Lighting	RSX1 LED P1 40K R4	
[Symbol]	26	D	Single	986	1.000	N.A.	13.1	340.6	Juno Lighting	WF6 SWS5 SDCRI MW
[Symbol]	122	SB	Single	133	1.000	N.A.	3.65	445.3	PLED	M-SV024-BL
[Symbol]	2	SB04	SF 4FT	133	1.000	N.A.	51.1	102.2	PLED	M-SV024-BL
[Symbol]	2	SB12	SF 12FT	133	1.000	N.A.	160.6	321.2	PLED	M-SV024-BL
[Symbol]	7	SF	Single	205	1.000	N.A.	3.79	26.53	P-LED	M-SX024-BL
[Symbol]	3	SF02	SF 2FT	205	1.000	N.A.	30.32	90.96	P-LED	M-SX024-BL
[Symbol]	2	SF04	SF 4FT	205	1.000	N.A.	53.06	106.12	P-LED	M-SX024-BL
[Symbol]	8	SF12	SF 12FT	205	1.000	N.A.	166.76	1334.08	P-LED	M-SX024-BL
[Symbol]	1	WP	Single	2913	1.030	B1-U0-G1	24.42	24.42	Lithonia Lighting	WPX1 LED 40K MVOLT EXXX DBLXD

DISCLAIMER
 ANY SITE PLANS, FLOOR PLANS, RENDERSHIPS, LIGHTING LAYOUTS AND PHOTO MAPPING PLANS INCLUDING BUT NOT LIMITED TO ANY PROJECTS CREATED OR PRODUCED BY RED LEONARD ASSOCIATES INC. ARE ONLY PREPARED FOR ILLUSTRATION AND NOT FOR CONSTRUCTION. RED LEONARD ASSOCIATES INC. DOES NOT WARRANT THE ACCURACY OF ANY INFORMATION PROVIDED IN THESE DOCUMENTS. RED LEONARD ASSOCIATES INC. DOES NOT WARRANT THE ACCURACY OF ANY INFORMATION PROVIDED IN THESE DOCUMENTS. RED LEONARD ASSOCIATES INC. DOES NOT WARRANT THE ACCURACY OF ANY INFORMATION PROVIDED IN THESE DOCUMENTS. RED LEONARD ASSOCIATES INC. DOES NOT WARRANT THE ACCURACY OF ANY INFORMATION PROVIDED IN THESE DOCUMENTS.

PROJECT NAME:
7-BREW
 DOWNERS GROVE, IL
 DRAWING NUMBER:
RL-10667-S1

SCALE: 1"=20'
 DATE: 09/29/25

RED LEONARD ASSOCIATES
 1340 Kemper Meadow Dr. Forest Park, GA 30050
 513-574-6500 | redleonard.com

REV.	BY	DATE	DESCRIPTION

AREA	QTY	LABEL	DESCRIPTION
	2	B2	RSX1 LED P1 40K R4
	4	B3	RSX1 LED P1 40K R4

ADDITIONAL FIXTURE INFO



RSX1 LED Area Luminaire

Specifications

- Area: 13.9 sq ft (1.28 sq m)
- Length: 13.9 sq ft (1.28 sq m)
- Height: 13.9 sq ft (1.28 sq m)
- Weight: 13.9 sq ft (1.28 sq m)
- Beam Spread: 13.9 sq ft (1.28 sq m)

Introduction

The RSX1 LED Area Luminaire delivers maximum value by providing exceptional energy savings, long life and consistent performance performance in an affordable price. The RSX1 delivers 1,000 to 1,100 lumens delivered at a range of 50K to 80K lux.

CS CONTRACTOR SELECT JUNO

Contractor Select™ Wf4 & Wf6 Sww5 4" & 6" Swivelable White Downlight LED Ultra-Thin Water

REVISIONS

Rev	Description
1	Issue for bid
2	Issue for bid

DOWNLIGHT	QTY	LABEL	DESCRIPTION
	26	D	Wf6 Sww5 Bocr1 Mw

ADDITIONAL FIXTURE INFO



Wf6 Sww5 Downlight LED

Specifications

- Beam Spread: 13.9 sq ft (1.28 sq m)
- Height: 13.9 sq ft (1.28 sq m)
- Weight: 13.9 sq ft (1.28 sq m)
- Beam Spread: 13.9 sq ft (1.28 sq m)

Introduction

The Wf6 Sww5 Downlight LED provides maximum value by providing exceptional energy savings, long life and consistent performance performance in an affordable price. The Wf6 Sww5 delivers 1,000 to 1,100 lumens delivered at a range of 50K to 80K lux.

CS CONTRACTOR SELECT JUNO

Contractor Select™ Wf4 & Wf6 Sww5 4" & 6" Swivelable White Downlight LED Ultra-Thin Water

REVISIONS

Rev	Description
1	Issue for bid
2	Issue for bid

FLEX POD	QTY	LABEL	DESCRIPTION
	122	S8	M-SV024-BL
	2	S804	M-SV024-BL
	2	S812	M-SV024-BL

ADDITIONAL FIXTURE INFO



Street Wrap™ Flex Pod

Specifications

- Beam Spread: 13.9 sq ft (1.28 sq m)
- Height: 13.9 sq ft (1.28 sq m)
- Weight: 13.9 sq ft (1.28 sq m)
- Beam Spread: 13.9 sq ft (1.28 sq m)

Introduction

The Street Wrap™ Flex Pod provides maximum value by providing exceptional energy savings, long life and consistent performance performance in an affordable price. The Street Wrap™ Flex Pod delivers 1,000 to 1,100 lumens delivered at a range of 50K to 80K lux.

CS CONTRACTOR SELECT JUNO

Contractor Select™ Wf4 & Wf6 Sww5 4" & 6" Swivelable White Downlight LED Ultra-Thin Water

REVISIONS

Rev	Description
1	Issue for bid
2	Issue for bid

FLEX BACK-BEND	QTY	LABEL	DESCRIPTION
	7	SF2	M-SX024-BL
	3	SF04	M-SX024-BL
	8	SF12	M-SX024-BL

ADDITIONAL FIXTURE INFO



Street Wrap™ Flex Back-Bend

Specifications

- Beam Spread: 13.9 sq ft (1.28 sq m)
- Height: 13.9 sq ft (1.28 sq m)
- Weight: 13.9 sq ft (1.28 sq m)
- Beam Spread: 13.9 sq ft (1.28 sq m)

Introduction

The Street Wrap™ Flex Back-Bend provides maximum value by providing exceptional energy savings, long life and consistent performance performance in an affordable price. The Street Wrap™ Flex Back-Bend delivers 1,000 to 1,100 lumens delivered at a range of 50K to 80K lux.

CS CONTRACTOR SELECT JUNO

Contractor Select™ Wf4 & Wf6 Sww5 4" & 6" Swivelable White Downlight LED Ultra-Thin Water

REVISIONS

Rev	Description
1	Issue for bid
2	Issue for bid

WALL MOUNTED	QTY	LABEL	DESCRIPTION
	1	WP	WP1 LED 40K MVOLT EXXX DLXLD

ADDITIONAL FIXTURE INFO



WP1 LED Wall Pack

Specifications

- Beam Spread: 13.9 sq ft (1.28 sq m)
- Height: 13.9 sq ft (1.28 sq m)
- Weight: 13.9 sq ft (1.28 sq m)
- Beam Spread: 13.9 sq ft (1.28 sq m)

Introduction

The WP1 LED wall pack provides maximum value by providing exceptional energy savings, long life and consistent performance performance in an affordable price. The WP1 LED wall pack delivers 1,000 to 1,100 lumens delivered at a range of 50K to 80K lux.

CS CONTRACTOR SELECT JUNO

Contractor Select™ Wf4 & Wf6 Sww5 4" & 6" Swivelable White Downlight LED Ultra-Thin Water

REVISIONS

Rev	Description
1	Issue for bid
2	Issue for bid

ORDERING INFORMATION

Accessories	Quantity	Description
...

EXTERNAL SHIELD



Internal Side Shield, External Glow Shield, External 360 Full View

POLE MOUNT INFORMATION

Round Pole Mount, Pole Top Mount

REPLACE BELLING

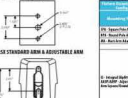

REPLACE DIMMER AND DIMMABLE DIM



CS CONTRACTOR SELECT JUNO

Specifications

...

Dimensions

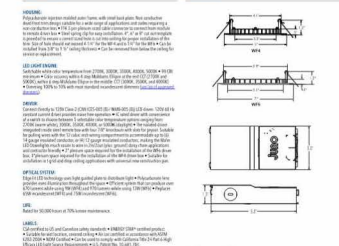

PERFORMANCE DATA

Model	Beam Spread	Height	Weight
...

STREET WRAP™ FLEX BACK-BEND

Accessories



INSTALLATION ACCESSORIES

...

End Caps

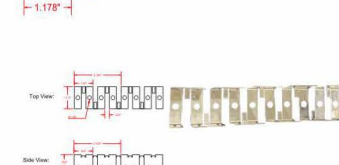

Wiring



Types of Feed



STREET WRAP™ FLEX BACK-BEND

Performance Data

Model	Beam Spread	Height	Weight
...

Lumen Output

Model	Beam Spread	Height	Weight
...

Emergency Egress Battery Pack

Model	Beam Spread	Height	Weight
...

Photometric Diagrams

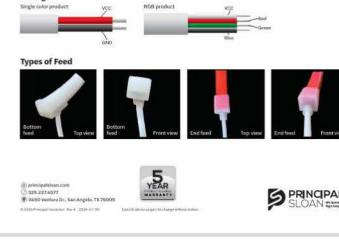

STREET WRAP™ FLEX BACK-BEND

Performance Data

Model	Beam Spread	Height	Weight
...

Lumen Output











Model	Beam Spread	Height	Weight
...

Emergency Egress Battery Pack

Model	Beam Spread	Height	Weight
...

Photometric Diagrams



	AREA	
	DOWNLIGHT	
	FLEX POD	
	FLEX PARK BEND	
	WALL MOUNTED	

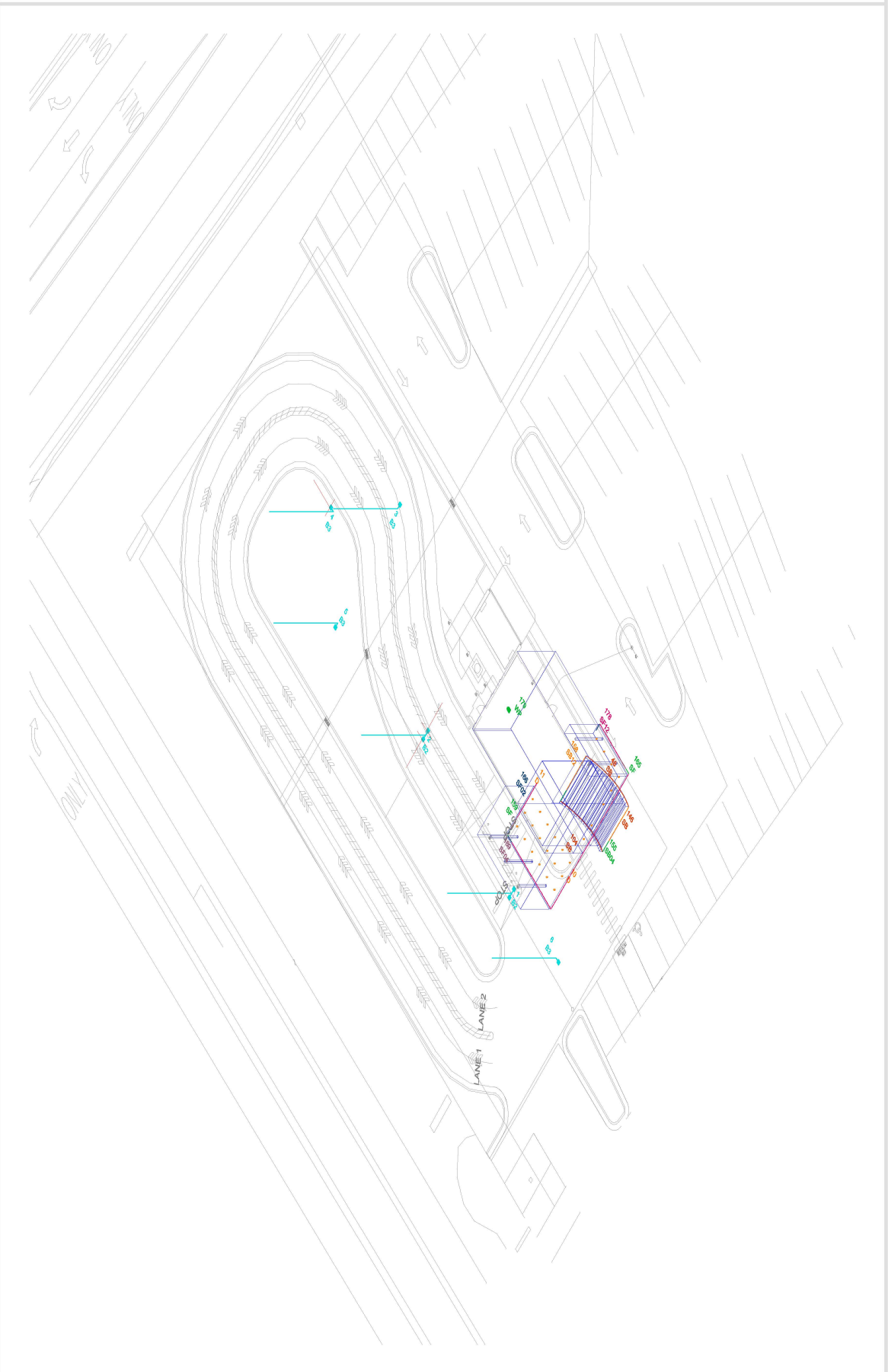

REDLEONARD ASSOCIATES
 1750 Kuper Avenue, 7th Floor, Chicago, IL 60610
 312-424-6000 | redleonard.com

THESE LAYOUTS AND SPECIFICATIONS ARE THE PROPERTY OF REDLEONARD ASSOCIATES, INC. AND SHALL REMAIN THE PROPERTY OF REDLEONARD ASSOCIATES, INC. ANY REPRODUCTION OR DISTRIBUTION OF THESE LAYOUTS AND SPECIFICATIONS WITHOUT THE WRITTEN PERMISSION OF REDLEONARD ASSOCIATES, INC. IS STRICTLY PROHIBITED. THE INFORMATION CONTAINED HEREIN IS FOR INFORMATIONAL PURPOSES ONLY AND DOES NOT CONSTITUTE AN OFFER OF ANY FINANCIAL PRODUCT OR SERVICE. THE INFORMATION CONTAINED HEREIN IS NOT INTENDED TO BE USED AS A BASIS FOR INVESTMENT OR OTHER FINANCIAL DECISIONS. THE INFORMATION CONTAINED HEREIN IS NOT INTENDED TO BE USED AS A BASIS FOR INVESTMENT OR OTHER FINANCIAL DECISIONS. THE INFORMATION CONTAINED HEREIN IS NOT INTENDED TO BE USED AS A BASIS FOR INVESTMENT OR OTHER FINANCIAL DECISIONS.

PROJECT NAME:
7-BREW
 DOWNERS GROVE, IL
 DRAWING NUMBER:
RL-10867-S1



Traffic Impact Study Proposed 7 Brew Coffee Shop

Downers Grove, Illinois



Prepared For:



December 18, 2025

1. Introduction

This report summarizes the methodologies, results, and findings of a traffic impact study conducted by Kenig, Lindgren, O'Hara, Aboona, Inc. (KLOA, Inc.) for a proposed 7 Brew coffee shop in Downers Grove, Illinois.

The site is located at 1432 Butterfield Road and is an outlot parcel within the Golf Galaxy and Best Buy shopping center. As proposed, the site will be developed to provide an approximately 515 square-foot 7 Brew coffee shop with dual drive-through lanes. 7 Brew locations do not provide indoor seating and all orders are facilitated through the drive-through. Access to the site will be provided via the existing access system serving the retail center.

The purpose of this study was to examine background traffic conditions, assess the impact that the proposed coffee shop will have on traffic conditions in the area, evaluate the adequacy of the drive through stacking and determine if any roadway or access improvements are necessary to accommodate the traffic generated by the proposed development. **Figure 1** shows the location of the site in relation to the area roadway system. **Figure 2** shows an aerial view of the site. The sections of this report present the following:

- Existing roadway conditions
- A description of the proposed development
- Directional distribution of the development traffic
- Vehicle trip generation for the proposed development
- Future traffic conditions including access to the development
- Traffic analyses for the weekday morning, weekday evening, and Saturday midday peak hours
- Recommendations with respect to adequacy of the site access and adjacent roadway system
- Evaluation of the drive through usage and stacking

Traffic capacity analyses were conducted for the weekday morning, weekday evening, and Saturday midday peak hours for the following conditions:

1. Existing Conditions – Analyzes the capacity of the existing roadway system using existing peak hour traffic volumes in the surrounding area.
2. Year 2031 No-Build Conditions – Analyzes the capacity of the existing roadway system using the ambient area growth not attributable to any particular development and any additional developments not associated with the development.
3. Year 2031 Projected Conditions – Analyzes the capacity of the future roadway system using the projected traffic volumes that include the existing traffic volumes, ambient traffic growth, and the traffic estimated to be generated by the full buildout of the proposed development.

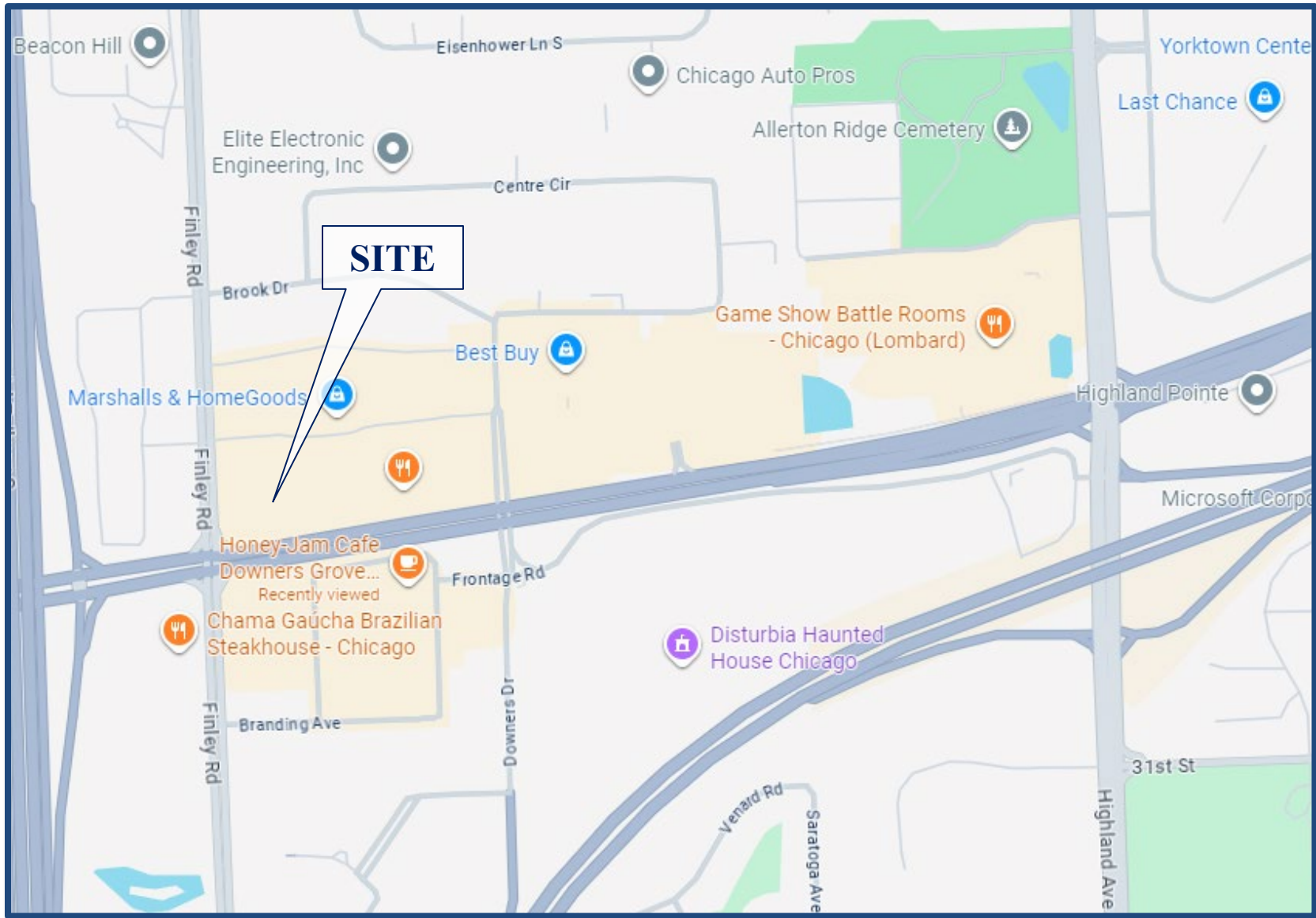

Site Location

Figure 1

*Proposed 7 Brew Coffee Shop
Downers Grove, Illinois*



Aerial View of Site

Figure 2

*Proposed 7 Brew Coffee Shop
Downers Grove, Illinois*

2. Existing Conditions

The following provides a description of the geographical location of the site, physical characteristics of the area roadway system including lane usage and traffic control devices, and existing peak hour traffic volumes.

Site Location

The site, which is an outlot parcel within the Golf Galaxy shopping center parking lot, is located at 1432 Butterfield Road and is bounded by the retail center parking lot to the north and east, Butterfield Road to the south, and Downers Drive to the west. Access to the retail center is currently provided via a signalized access drive off Downers Drive and a right-in/right-out access drive off Butterfield Road. Land uses within the plaza are commercial and include Golf Galaxy, Best Buy, a Disc Replay music store, a Great Clips barber shop, and Town Eye Care.

Existing Roadway System Characteristics

The characteristics of the existing roadways near the site are described below and illustrated in **Figure 3**.

IL 56 (Butterfield Road) is an east-west other principal arterial roadway that in the vicinity of the site provides two travel lanes in each direction east of Downers Drive and three travel lanes in each direction west of Downers Drive. At its signalized intersection with Downers Drive, Butterfield Road provides two exclusive left-turn lanes, three through lanes, and an exclusive right-turn lane on the eastbound and westbound approaches. At its unsignalized intersection with the right-in/right-out retail center access drive, Butterfield Road provides two through lanes and a shared through/right-turn lane on the westbound approach. Butterfield Road is designated as a Strategic Regional Arterial (SRA), is under the jurisdiction of the Illinois Department of Transportation (IDOT) and carries an Annual Average Daily Traffic (AADT) volume of 40,800 vehicles (IDOT 2023). Butterfield Road has a posted speed limit of 45 miles per hour.

Downers Drive is a north-south minor collector roadway that in the vicinity of the site provides two travel lanes in each direction. At its signalized intersection with Butterfield Road, Downers Drive provides an exclusive left-turn lane and a shared through/right-turn lane on the northbound approach and an exclusive left-turn lane, a through lane, and an exclusive right-turn lane on the southbound approach. At its signalized intersection with the retail center access road, Downers Drive provides a shared left-turn/through lane and a shared through/right-turn lane on the northbound and southbound approaches. Both approaches are under stop sign control and the southbound approach provides a high-visibility crosswalk. Downers Drive is under the jurisdiction of the Village of Downers Grove, carries an AADT volume of 1,450 vehicles (IDOT 2024), and has a posted speed limit of 25 miles per hour.

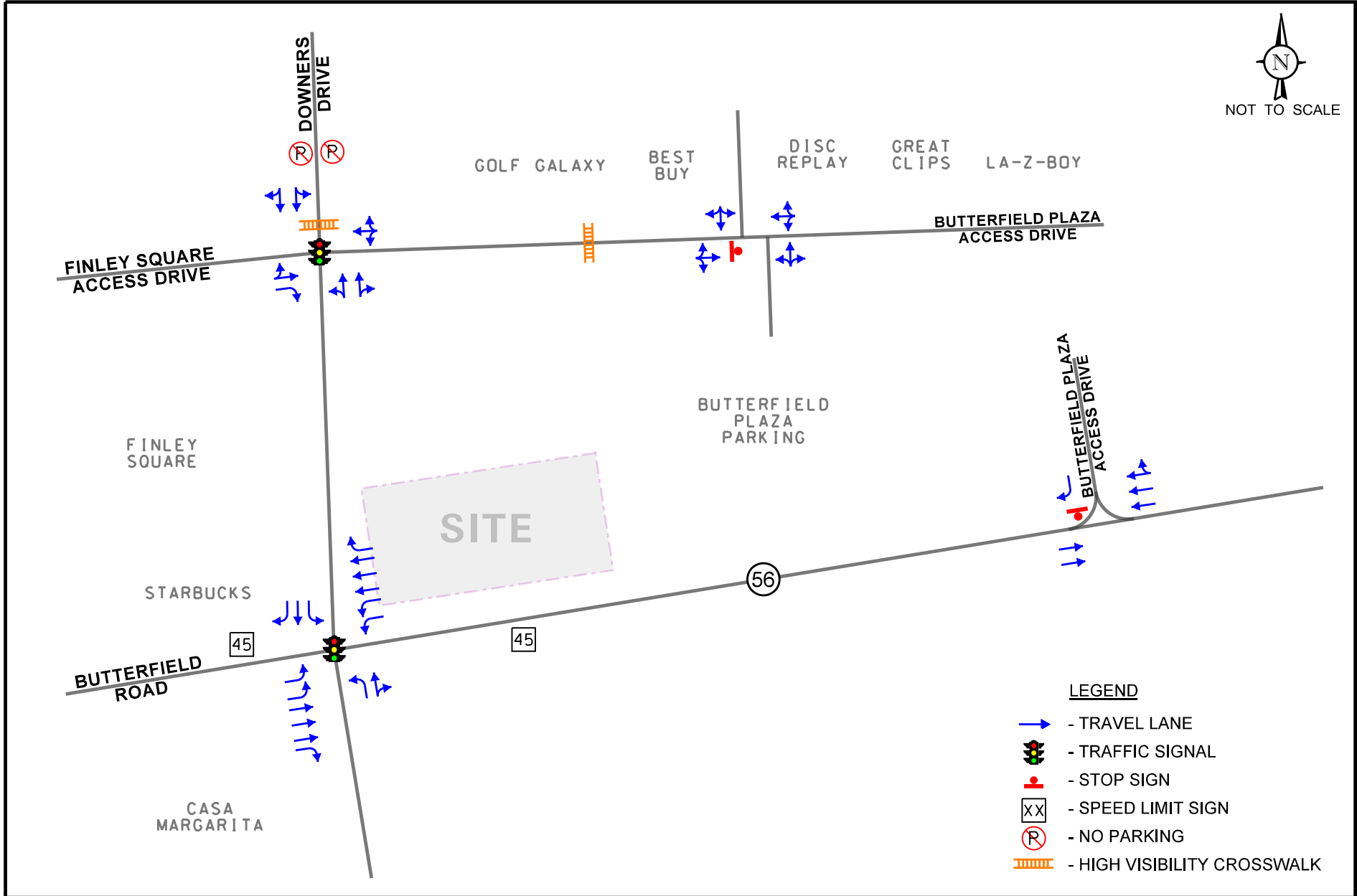
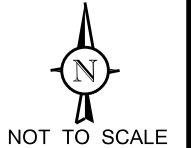

- LEGEND**
- TRAVEL LANE
 - TRAFFIC SIGNAL
 - STOP SIGN
 - SPEED LIMIT SIGN
 - NO PARKING
 - HIGH VISIBILITY CROSSWALK

7-Brew
Downers Grove, Illinois

Existing Roadway Characteristics

KLOA
Kenig, Lindgren, O'Hara, Aboona, Inc.
Job No: 25-209 Figure: 3

Traffic Signal Interconnect

The intersection of Butterfield Road with Downers Drive is part of a seven-signal traffic signal interconnect system that spans approximately 3,700 feet and includes the intersections of Butterfield Road with Lacey Road/Lloyd Avenue, Esplanade Road, the east and west I-355 ramps, and Finley Road and Woodcreek Drive with Lacey Road.

Existing Traffic Volumes

In order to determine current traffic conditions in the vicinity of the site, KLOA, Inc. conducted peak period traffic counts on Thursday, August 7, 2025 during the weekday morning (7:00 to 9:00 A.M.) and weekday evening (4:00 to 6:00 P.M.) peak periods and on Saturday, August 9, 2025 during the midday (12:00 to 2:00 P.M.) at the following intersections:

- Downers Drive with Butterfield Road
- Downers Drive with the signalized retail center access drive
- Butterfield Road with right-in/right-out retail center access drive
- An internal intersection with the retail center

The results of the traffic counts indicate that the weekday morning peak hour of traffic occurs from 7:45 A.M. to 8:45 A.M., the weekday evening peak hour of traffic occurs from 4:30 P.M. to 5:30 P.M., and the Saturday midday peak hour of traffic occurs from 1:00 P.M. to 2:00 P.M. **Figure 4** illustrates the existing peak hour traffic volumes. Copies of the traffic count summary sheets are included in the Appendix.

Crash Summary

KLOA, Inc. obtained crash data for the past five years (2020 to 2024) for the intersections of Butterfield Road with Downers Drive and Downers Drive with the retail center access road. It should be noted that the intersection of Downers Drive with the retail center access road experienced an average of less than one crash per year. **Table 1** provides a summary of the crash data at the intersection of Butterfield Road and Downers Drive. A review of the crash data showed that no fatalities were reported during the study period.¹

¹ IDOT DISCLAIMER: The motor vehicle crash data referenced herein was provided by the Illinois Department of Transportation. Any conclusions drawn from analysis of the aforementioned data are the sole responsibility of the data recipient(s).

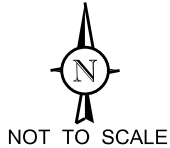
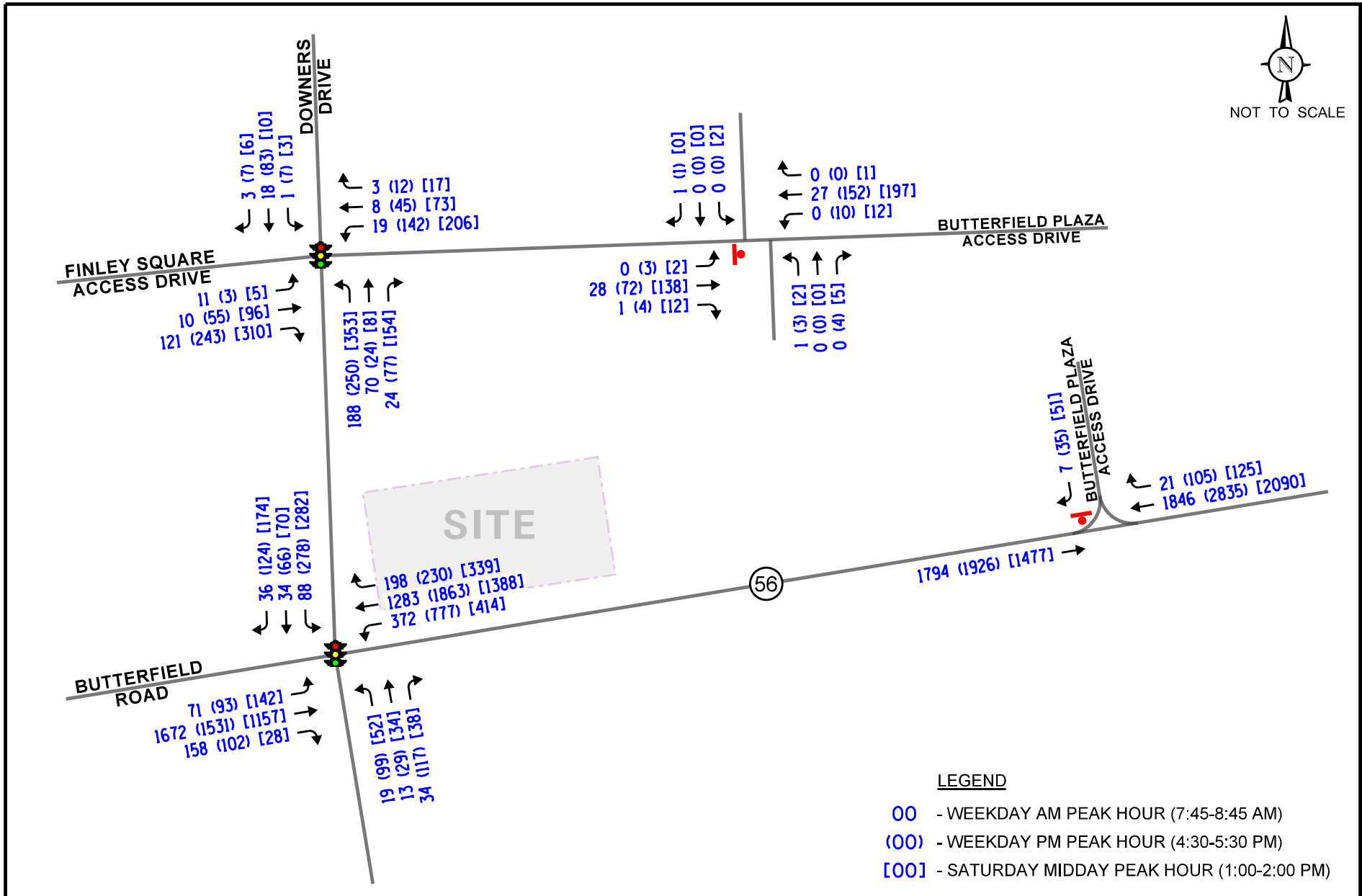

7-Brew
Downers Grove, Illinois

Existing Traffic Volumes

KLOA
Kenig, Lindgren, O'Hara, Aboona, Inc.
Job No: 25-209 Figure: 4

Table 1
 GOLF ROAD WITH SOUTH ACCESS DRIVE – CRASH SUMMARY

Year	Type of Crash								Severity		
	A	HO	O	RE	S	T	Other	Total	PD	I	F
2020	1	0	0	6	0	0	0	7	4	3	0
2021	2	0	0	0	0	4	0	6	3	3	0
2022	1	0	0	5	0	3	0	9	6	3	0
2023	1	0	0	3	0	6	1	11	5	6	0
2024	<u>0</u>	<u>0</u>	<u>0</u>	<u>2</u>	<u>1</u>	<u>3</u>	<u>1</u>	<u>7</u>	<u>3</u>	<u>4</u>	<u>0</u>
Total	5	0	0	16	1	16	2	40	21	19	0
Avg	1.0	--	--	3.2	<1.0	3.2	<1.0	8.0	4.2	3.8	--
A – Angle; HO – Head On; O – Object; RE – Rear End; S – Sideswipe; T – Turning PD – Property Damage; I – Injury; F - Fatal											

3. Traffic Characteristics of the Proposed Development

In order to properly evaluate future traffic conditions in the surrounding area, it was necessary to determine the traffic characteristics of the proposed development, including the directional distribution and volumes of traffic that it will generate.

Proposed Site and Development Plan

As proposed, the site will be developed to provide an approximately 515 square-foot 7 Brew coffee shop with dual drive-through lanes. 7 Brew locations do not provide indoor seating and all orders are facilitated through the drive-through. Access to the site will be provided via the internal access system serving the retail center which consists of the following main access drives:

- A signalized, full-movement access road off Downers Drive located approximately 450 feet north of the intersection of Downers Drive with Butterfield Road. The access drive provides one inbound lane and an outbound lane that is wide enough to accommodate an exclusive left-turn lane and a shared through/right-turn lane.
- A right-in/right-out access drive on the north side of Butterfield Road located approximately 820 feet west of the intersection of Downers Drive with Butterfield Road. The access drive provides one inbound lane and one outbound lane with outbound movements under stop sign control.

As previously indicated, the proposed 7 Brew coffee shop is a drive-through coffee shop with no indoor seating and customers are served only via the drive-through. To accommodate the anticipated peak queue of the 7 Brew, the site has been sized and designed to accommodate stacking for approximately 39 vehicles. A thorough discussion of the drive through design, operations, available and estimated stacking is included later in this report.

Upon buildout of the restaurant, the balance of the planned unit development will provide 320 parking spaces and parking for 7 Brew employees will be accommodated via seven spaces.

A copy of the preliminary site plan is included in the Appendix.

Directional Distribution

The directions from which vehicles will approach and depart the site were estimated based on existing travel patterns, as determined from the traffic counts. **Figure 5** illustrates the directional distribution of the site-generated traffic.

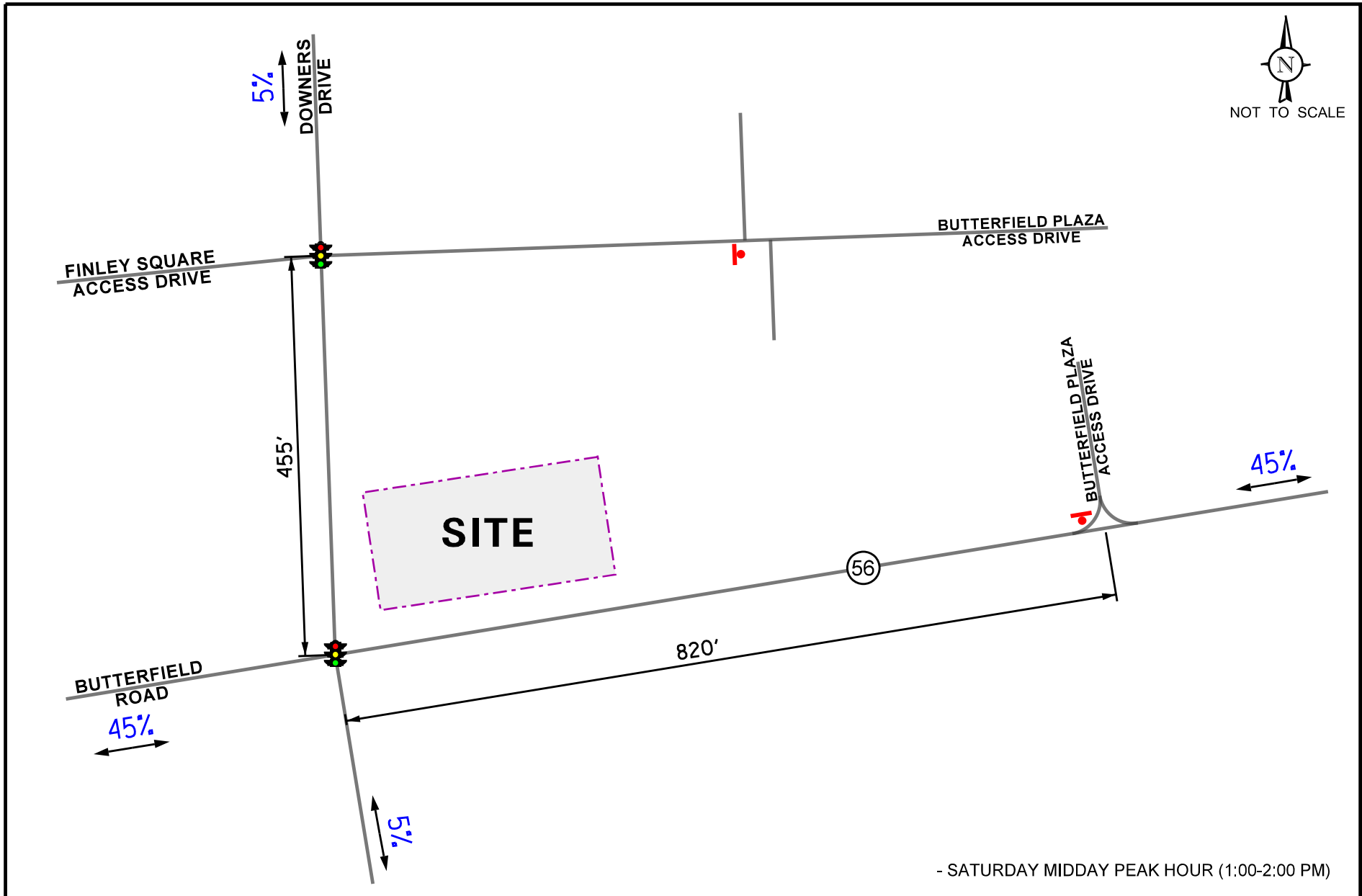

- SATURDAY MIDDAY PEAK HOUR (1:00-2:00 PM)

7-Brew
Downers Grove, Illinois

Directional Distribution



Job No: 25-209 Figure: 5

Trip Generation Estimates

The number of peak hour trips estimated to be generated by the proposed coffee shop was based on the following:

- Vehicle trip generation rates contained in *Trip Generation Manual*, 12th Edition, published by the Institute of Transportation Engineers (ITE). The “Coffee/Donut Shop with Drive-Through Window and No Indoor Seating” (Land-Use Code 938) trip rates were utilized.
- Trip generation surveys conducted at the existing 7 Brew coffee locations at 1203 Iroquois Avenue in Naperville, 880 S. Rand Road in Lake Zurich, and 12980 IL Route 47 in Huntley.

Table 2 summarizes the trips projected to be generated by the proposed development based on each methodology during the peak hours and daily, respectively. As can be seen from Table 2, the trips generation surveys yield the highest trip generation and as such, the average trips based on the trip generation surveys were utilized as the base trip generation for the purposes of this evaluation.

It should be noted that based on information provided by ITE, approximately 70 percent of trips made to drive-through coffee shops are diverted from the existing traffic on the area roadway system according to ITE surveys. This is particularly true during the weekday morning and weekday evening peak hours when traffic is diverted from home-to-work and work-to-home trips. Such diverted trips are referred to as pass-by traffic.

Furthermore, given that the subject site is an outlot parcel within a larger shopping center, it is anticipated that trips generated by 7 Brew will be multi-purpose trips to other land uses within the shopping center. However, no interaction reduction was applied to the estimated trip generation to provide a conservative (worst-case) scenario.

Lastly, it should be noted that this trip generation is conservatively high as the 7 Brew coffee chain is new to the Chicagoland area which results in attracting customers from a larger trade area than established stores in other markets in the United States. As such, the trip generation for the four existing stores is higher-than-average trip generation for a typical 7 Brew coffee shop. As more 7 Brew locations open within the Chicagoland area, it is anticipated that the trip generation rates will decrease and stabilize. However, for the purposes of this evaluation, no reduction was applied to the trip generation to account for this in order to provide a conservative (worst-case) scenario.

Table 2

PROJECTED SITE-GENERATED TRAFFIC VOLUMES – PEAK HOURS

Methodology	Weekday Morning Peak Hour ¹			Weekday Evening Peak Hour ¹			Saturday Midday Peak Hour ¹		
	In	Out	Total	In	Out	Total	In	Out	Total
ITE Land-Use Code 938 (2 Drive Through Lanes)	44	45	89	15	15	30	--	--	--
Trip Generation Surveys (Naperville 7 Brew)	93	89	182	94	98	192	108	110	218
Trip Generation Surveys (Lake Zurich 7 Brew)	79	82	161	64	68	132	79	81	160
Trip Generation Surveys (Huntley 7 Brew)	103	97	200	86	95	181	94	92	186
Trip Generation Surveys (Average)	92	89	181	81	87	168	94	94	188
<i>Pass-By Reduction (70%)</i>	<i>-64</i>	<i>-64</i>	<i>-128</i>	<i>-61</i>	<i>-61</i>	<i>-121</i>	<i>-66</i>	<i>-66</i>	<i>-132</i>
Total New Trips	28	25	53	20	26	47	28	28	56

1 – Peak hour of adjacent roadway traffic

4. Projected Traffic Conditions

The total projected traffic volumes include the existing traffic volumes, increase in background traffic due to growth, and the traffic estimated to be generated by the proposed development.

Site Traffic Assignment

The estimated peak hour traffic volumes that will be generated by the proposed development were assigned to the roadway system in accordance with the previously described directional distribution (Figure 5). The new site traffic assignment is illustrated in **Figure 6**. The pass-by trip assignment is illustrated in **Figure 7**.

Background (No-Build) Traffic Conditions

The existing traffic volumes (Figure 4) were increased by a regional growth factor to account for the increase in existing traffic related to regional growth in the area (i.e., not attributable to any particular planned development). Based on Average Daily Traffic (ADT) projections provided by the Chicago Metropolitan Agency for Planning (CMAP), the existing traffic volumes were increased by an annually compounded growth rate of 0.25 percent per year for six years (buildout year plus five years) for a total of approximately 1.5 percent to project Year 2031 background conditions. A copy of the CMAP 2050 projections letter is included in the Appendix.

The no-build traffic volumes also take into consideration the traffic estimated to be generated by the recently opened Wendy's restaurant located at 1362 Butterfield Road, which will share the same access system serving the retail center and proposed 7 Brew.

Figure 8 illustrates the Year 2031 no-build conditions.

Total Projected Traffic Volumes

The site-generated traffic (Figures 6) was added to the existing traffic volumes increased by the regional growth factor (Figure 8) to determine the Year 2031 total projected traffic volumes, shown in **Figure 9**.

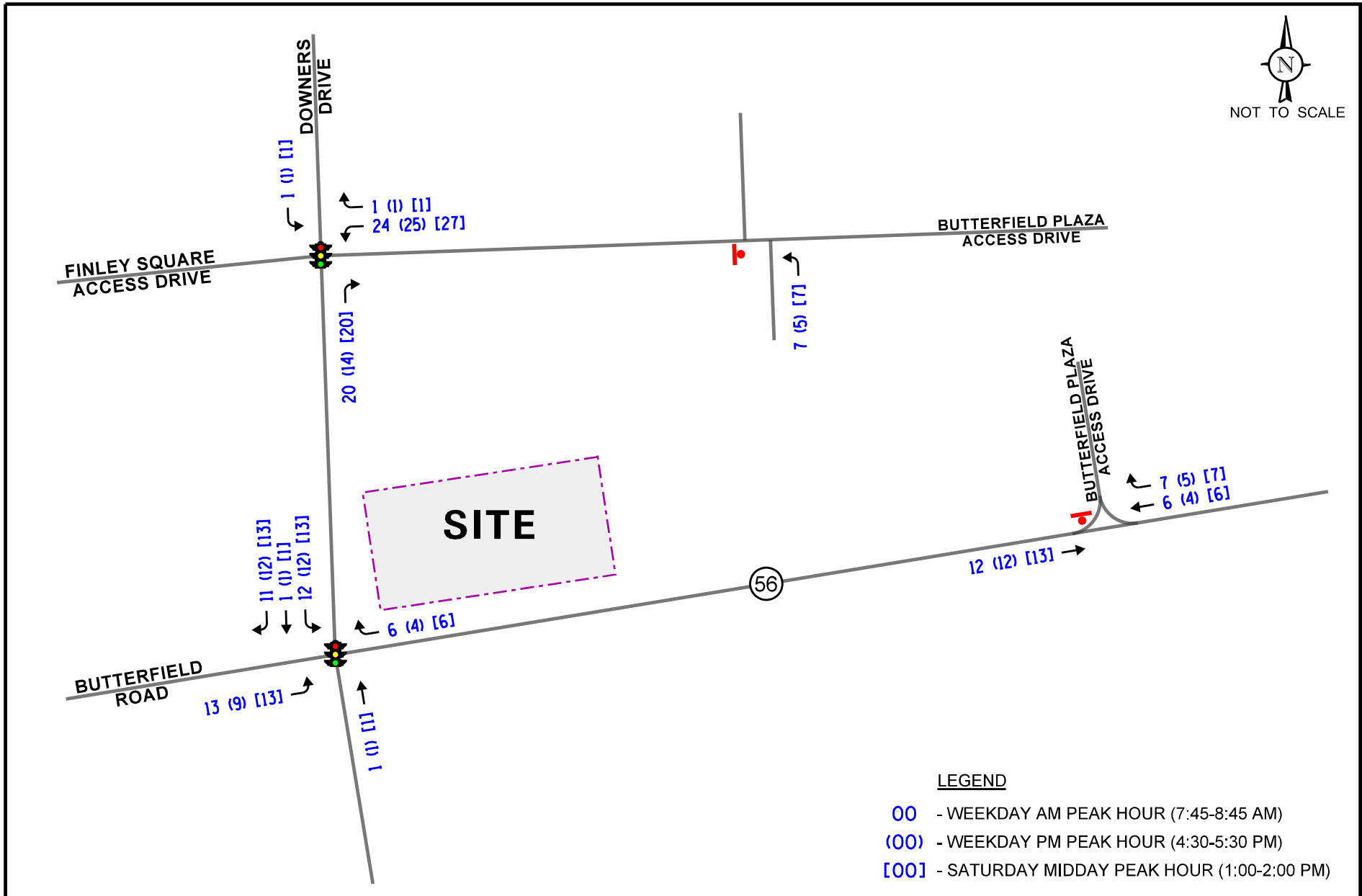

7-Brew
Downers Grove, Illinois

New Site Traffic Volumes



Job No: 25-209

Figure: 6

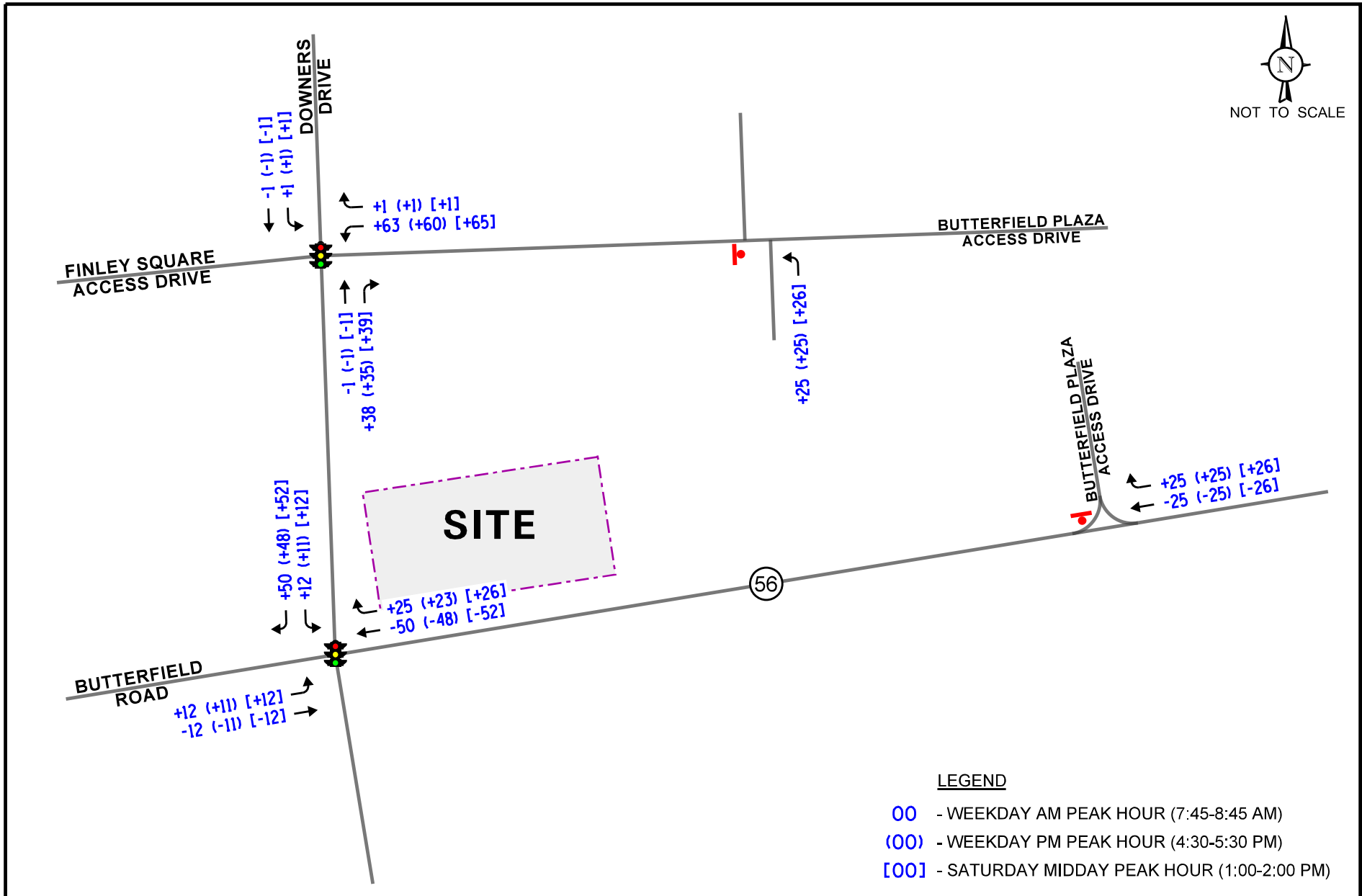

7-Brew
Downers Grove, Illinois

Pass-By Traffic Volumes



Job No: 25-209

Figure: 7

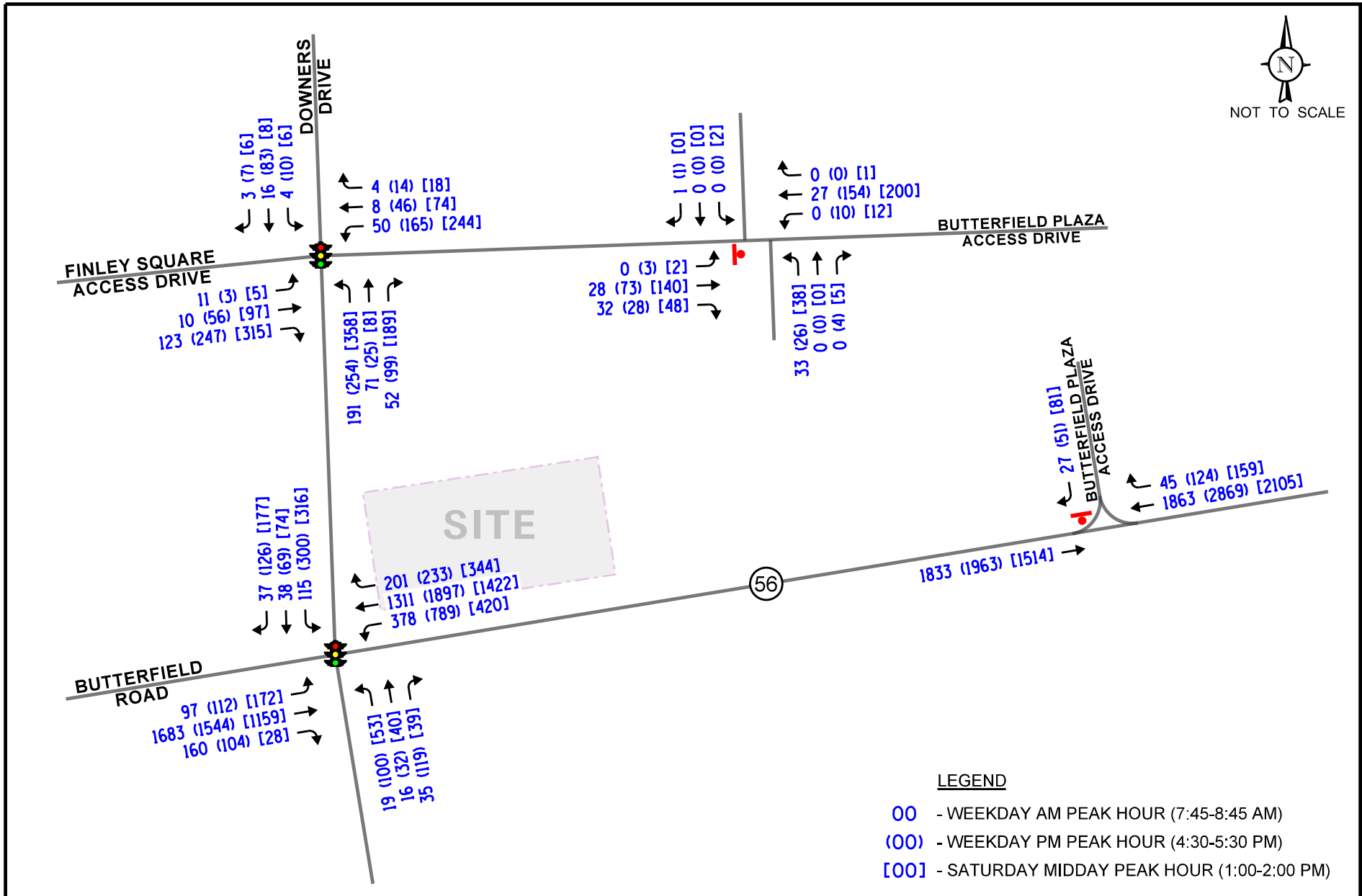

7-Brew
Downers Grove, Illinois

Year 2031 No-Build Traffic Volumes



Job No: 25-209

Figure: 8

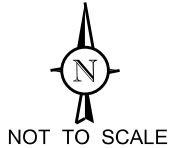
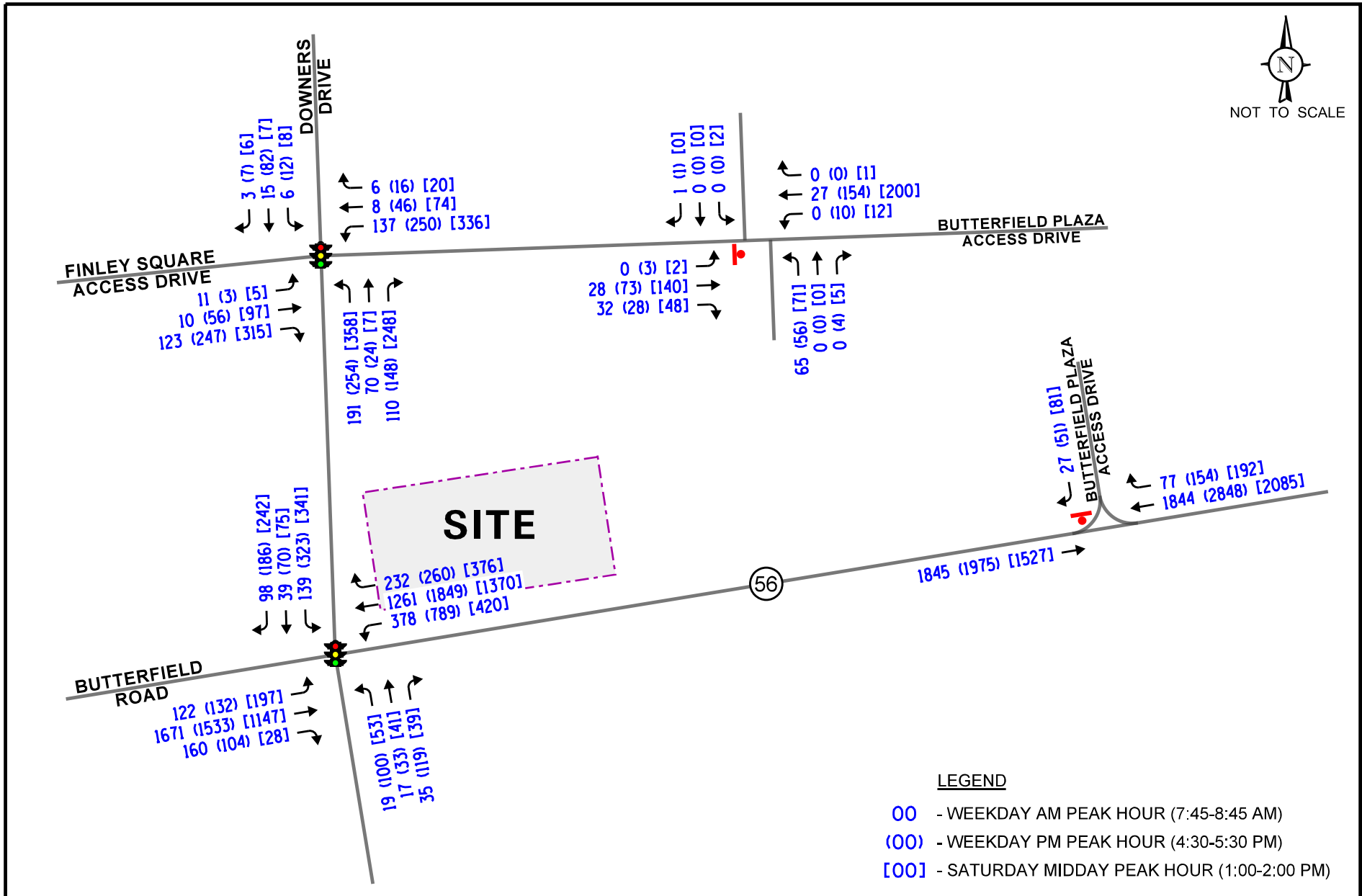

7-Brew
Downers Grove, Illinois

Year 2031 Total Traffic Volumes

KLOA
Kenig, Lindgren, O'Hara, Aboona, Inc.
Job No: 25-209 Figure: 9

5. Traffic Analysis and Recommendations

The following provides an evaluation conducted for the weekday morning, weekday evening, and Saturday midday peak hours. The analysis includes conducting capacity analyses to determine how well the roadway system and access drives are projected to operate and whether any roadway improvements or modifications are required.

Traffic Analyses

Roadway and adjacent or nearby intersection analyses were performed for the weekday morning, weekday evening, and Saturday midday peak hours for the existing (Year 2025), no-build, and future projected (Year 2031) traffic volumes.

The traffic analyses were performed using the methodologies outlined in the Transportation Research Board's *Highway Capacity Manual (HCM)*, 7th Edition and analyzed using Synchro/SimTraffic 12 software. The analyses for the signalized intersection of Butterfield Road with Downers Drive was accomplished utilizing actual cycle lengths, phasings, and offsets. The analyses for the signalized intersection of Downers Drive with the retail center access drive were accomplished utilizing field measured cycle lengths.

The analyses for the unsignalized intersections determine the average control delay to vehicles at an intersection. Control delay is the elapsed time from a vehicle joining the queue at a stop sign (includes the time required to decelerate to a stop) until its departure from the stop sign and resumption of free flow speed. The methodology analyzes each intersection approach controlled by a stop sign and considers traffic volumes on all approaches and lane characteristics.

The ability of an intersection to accommodate traffic flow is expressed in terms of level of service, which is assigned a letter from A to F based on the average control delay experienced by vehicles passing through the intersection. The *Highway Capacity Manual* definitions for levels of service and the corresponding control delay for signalized intersections and unsignalized intersections are included in the Appendix of this report.

Summaries of the traffic analysis results showing the level of service and overall intersection delay (measured in seconds) for the existing, Year 2031 no-build, and Year 2031 total projected conditions are presented in **Tables 3** through **7**. A discussion of the intersections follows. Summary sheets for the capacity analyses are included in the Appendix.

Table 3
CAPACITY ANALYSIS RESULTS – BUTTERFIELD ROAD WITH DOWNERS DRIVE – SIGNALIZED

	Peak Hour	Eastbound			Westbound			Northbound		Southbound			Overall
		L	T	R	L	T	R	L	T/R	L	T	R	
Existing Conditions	Weekday Morning	E	B	A	E	B	A	D	C	D	D	A	C 20.6
		59.6	19.6	2.8	59.2	10.6	1.7	42.5	30.2	51.8	53.1	0.4	
	B – 19.7			B – 19.4			C – 33.7		D – 40.4				
	Weekday Evening	E	D	A	E	C	A	D	C	F	E	B	D 36.7
		67.6	43.1	1.7	58.1	20.7	2.3	42.7	30.5	85.1	55.3	16.1	
	D – 42.0			C – 29.3			D – 35.4		E – 62.7				
Saturday Midday	D	C	A	D	C	A	C	C	C	C	A	C 25.8	
	49.1	26.7	0.1	49.6	22.1	3.4	23.6	25.5	34.4	33.8	4.4		
C – 28.5			C – 24.5			C – 24.7		C – 24.4					
No-Build Conditions	Weekday Morning	E	B	A	E	B	A	D	C	E	D	A	C 21.8
		60.0	19.8	2.8	59.7	11.8	1.9	42.2	31.1	57.7	53.1	0.4	
	C – 20.4			C – 20.3			C – 34.1		D – 45.6				
	Weekday Evening	E	D	A	E	C	A	D	D	F	D	B	D 38.7
		70.1	44.5	1.9	58.4	21.4	2.3	42.2	36.2	99+	55.0	16.3	
	D – 43.6			C – 29.9			D – 38.6		E – 73.7				
Saturday Midday	D	C	A	D	C	A	C	C	D	C	A	C 26.7	
	51.1	27.2	0.1	50.2	23.0	3.5	23.4	26.6	36.7	33.6	4.4		
C – 29.7			C – 25.1			C – 25.3		C – 26.2					
Projected Conditions	Weekday Morning	E	B	A	E	B	A	D	C	E	D	A	C 22.4
		61.0	19.7	2.8	59.7	11.9	1.9	42.2	31.4	66.1	53.1	8.7	
	C – 20.9			C – 20.3			C – 34.4		D – 43.8				
	Weekday Evening	E	D	A	E	C	A	D	D	F	D	C	D 39.3
		72.6	44.4	1.9	58.6	21.4	2.3	42.1	37.8	99+	54.9	25.6	
	D – 44.0			C – 29.8			D – 39.5		E – 72.8				
Saturday Midday	D	C	A	D	C	A	C	C	D	C	A	C 26.9	
	52.7	27.2	0.1	50.2	23.0	3.5	23.4	26.8	39.4	33.6	6.3		
C – 30.3			C – 24.9			C – 25.4		C – 26.6					
Letter denotes Level of Service		L – Left Turn		R – Right Turn									
Delay is measured in seconds.		T – Through											

Table 4
CAPACITY ANALYSIS RESULTS – DOWNERS DRIVE WITH RETAIL CENTER ACCESS ROAD – SIGNALIZED

	Peak Hour	Eastbound		Westbound		Northbound			Southbound			Overall
		L/T	R	L	T/R	L	T	R	L	T	R	
Existing Conditions	Weekday Morning	B 13.6	A 5.9	B 13.6	B 12.0	A 5.5			A 4.9			A 6.4
		A – 7.0		B – 13.0								
	Weekday Evening	B 15.2	A 5.5	C 20.4	B 13.0	A 6.4			A 6.2			A 9.1
		A – 7.3		B – 18.2								
	Saturday Midday	B 13.4	A 4.7	C 20.9	B 11.4	A 7.4			A 6.1			A 9.8
		A – 6.9		B – 18.0								
No-Build Conditions	Weekday Morning	B 14.4	A 6.1	B 15.6	B 12.4	A 5.0			A 4.7			A 6.8
		A – 7.3		B – 15.0								
	Weekday Evening	B 15.8	A 5.5	C 22.4	B 13.3	A 6.1			A 6.3			A 9.6
		A – 7.5		B – 20.0								
	Saturday Midday	B 14.1	A 4.8	C 25.3	B 11.9	A 7.2			A 5.9			B 10.8
		A – 7.0		C – 21.6								
Projected Conditions	Weekday Morning	B 16.0	A 6.7	C 27.0	B 12.9	A 4.4			A 4.4			A 9.8
		A – 8.1		C – 25.6								
	Weekday Evening	B 16.3	A 5.3	C 31.9	B 13.5	A 5.8			A 6.4			B 12.4
		A – 7.4		C – 28.2								
	Saturday Midday	B 15.3	A 4.9	D 41.0	B 12.9	A 6.6			A 5.7			B 15.0
		A – 7.4		C – 34.9								
Letter denotes Level of Service L – Left Turn R – Right Turn Delay is measured in seconds. T – Through												

Table 5

CAPACITY ANALYSIS RESULTS – EXISTING CONDITIONS – UNSIGNALIZED

Intersection	Weekday Morning Peak Hour		Weekday Evening Peak Hour		Saturday Midday Peak Hour	
	LOS	Delay	LOS	Delay	LOS	Delay
Butterfield Road with Right-in/Right-Out Retail Center Access Drive¹						
• Southbound Approach	C	23.7	F	62.2	D	30.3
Retail Center Internal Intersection²						
• Intersection Capacity Utilization (ICU)	A	13.3%	A	22.0%	A	27.6%
LOS = Level of Service Delay is measured in seconds.			1 – Two-way stop control 2 – One-way stop control			

Table 6

CAPACITY ANALYSIS RESULTS – NO-BUILD CONDITIONS – UNSIGNALIZED

Intersection	Weekday Morning Peak Hour		Weekday Evening Peak Hour		Saturday Midday Peak Hour	
	LOS	Delay	LOS	Delay	LOS	Delay
Butterfield Road with Right-in/Right-Out Retail Center Access Drive¹						
• Southbound Approach	D	26.3	F	83.0	E	37.3
Retail Center Internal Intersection²						
• Intersection Capacity Utilization (ICU)	A	18.6%	A	27.7%	A	28.5%
LOS = Level of Service Delay is measured in seconds.			1 – Two-way stop control 2 – One-way stop control			

Table 7
CAPACITY ANALYSIS RESULTS – PROJECTED CONDITIONS – UNSIGNALIZED

Intersection	Weekday Morning Peak Hour		Weekday Evening Peak Hour		Saturday Midday Peak Hour	
	LOS	Delay	LOS	Delay	LOS	Delay
Butterfield Road with Right-in/Right-Out Retail Center Access Drive¹						
• Southbound Approach	D	26.0	F	80.5	E	36.5
Retail Center Internal Intersection²						
• Intersection Capacity Utilization (ICU)	A	20.4%	A	29.3%	A	28.8%
LOS = Level of Service Delay is measured in seconds.			1 – Two-way stop control 2 – One-way stop control			

Discussion and Recommendations

The following summarizes how the intersections are projected to operate and identifies any roadway and traffic control improvements necessary to accommodate the site-generated traffic. It should be noted that the results of the capacity analyses are reflective of a worst-case evaluation given that no interaction reduction was applied to the estimated vehicle trip generation, and the trip generation was not reduced to account for a stabilized Chicagoland market in which more 7 Brew locations are constructed and operational.

Butterfield Road with Downers Drive

The results of the capacity analysis indicate the following:

- The intersection overall currently operates at Level of Service (LOS) D or better during the weekday morning, weekday evening, and Saturday midday peak hours.
- Through movements on the eastbound and westbound approaches currently operate at LOS D or better and through movements on the northbound and southbound approaches currently operate at LOS E or better. However, this is due to the limited green time given to the northbound and southbound approaches.
- Left-turn movements on all approaches currently operate at LOS E or better during the peak hours except the southbound left turn during the weekday evening peak hour which operates at LOS F.
 - The high delay for eastbound and westbound movements is to be expected as they operate under a protected phase.
 - 95th percentile queues for the southbound left-turn movement extend to but not past the intersection of Downers Drive with the retail access road. Additionally, the v/c ratio is less than one.
- Under no-build and total projected conditions, the intersection overall is projected to continue operating at existing levels of service during the peak hours. All approaches are projected to continue operating at existing LOS except the eastbound and westbound approaches which are projected to operate at LOS C during the weekday morning peak hour.
 - 95th percentile queues for the southbound left-turn movement are projected to extend past the intersection of Downers Drive with the retail center access road. However, the traffic projected to be generated by the coffee shop is only increasing the volume for this movement by approximately seven percent.
 - A review of the simulation indicates that the queue will extend into the shopping centers and take two cycles to clear.

As previously indicated, the trip generation surveys conducted at the existing 7 Brew locations were utilized as is, without taking any reduction in trip generation to account for additional 7 Brew locations to be constructed in the Chicagoland area, as discussed in the following section. Therefore, the results of the capacity analysis represent a conservative (worst-case) analysis.

Downers Drive with Retail Center Access Road

It should be noted that the westbound approach of this intersection is not striped to provide an exclusive lane. However, for the purposes of the analyses (given the approach is wide enough to accommodate two travel lanes), it was assumed that the westbound approach functions as a left-turn lane and a shared through/right-turn lane. The results of the capacity analysis indicate the following:

- The westbound approach currently operates at LOS B during the peak hours and all movements operate at LOS A during the peak hours.
- Under no-build conditions the intersection and all movements are projected to continue to operate at existing LOS except the westbound approach during the Saturday midday peak hour which is projected to operate at LOS C.
- Under total projected conditions, all approaches are projected to continue to operate at existing LOS during the peak hours except the westbound approach which is projected to operate at LOS C during all three peak hours.

Overall, this access drive will be adequate in accommodating the traffic estimated to be generated by the proposed 7 Brew and no roadway or traffic control improvements are required.

As previously indicated, the 95th percentile queue of the southbound left-turn movement at the intersection of Butterfield Road with Downers Drive is projected to extend past this intersection. A review of the simulation shows that these queues will impede the ability of vehicles to leave the shopping center.

Butterfield Road with right-in/right-out retail center access drive

The results of the capacity analysis indicate that the southbound approach currently operates at LOS C, F, and D during the weekday morning, weekday evening, and Saturday midday peak hours. The delays experienced during the weekday evening peak hour are expected due to the high volume of through traffic on Butterfield Road which is a principal arterial roadway and an IDOT SRA route. Further, the 95th percentile queue is only one to two vehicles.

Under no-build and projected conditions, the southbound approach is projected to continue to operate at LOS D, F, and E during the peak hours. The 95th percentile queue is projected to be two to three vehicles. As such, this intersection will be adequate in accommodating the traffic estimated to be generated by the proposed 7 Brew and will ensure efficient and flexible access is provided to the site. No roadway or traffic control improvements will be required.

Retail Center Internal Intersection

Because of the traffic control configuration of this intersection where the eastbound traffic is under stop sign control and the other three approaches are free, the intersection could not be analyzed using HCM procedures. Given this traffic control configuration and the limitations of the HCM procedures, the intersection was analyzed using the intersection capacity utilization (ICU) level of service. The ICU indicates how much reserve capacity is available or how much an intersection is over capacity.

Based on the ICU analysis, the intersection currently utilizes approximately 13 percent of the capacity of the intersection during the weekday morning peak hour, approximately 22 percent of its capacity during the weekday evening peak hour, and approximately 28 percent of its capacity during the Saturday midday peak hour. Under future conditions it is projected that the intersection will utilize approximately 20 percent of its capacity during the weekday morning peak hour and 29 percent of its capacity during the weekday evening and Saturday midday peak hours. As a result, the intersection will continue to operate efficiently and with minimal delays.

Drive-Through Evaluation

As previously indicated, the site will provide dual drive-through lanes. Typical of all 7 Brew sites, there is no ordering board or ordering speakers and all orders are taken by team members via iPads within the drive-through lanes. Payment is taken at the time of ordering. Vehicles circulate the site and pick up their orders at the front of the drive-through queue where team members walk orders to the vehicles. At the proposed site, access will be provided via the lanes serving the existing retail center parking lot. The order pick-up area is located on the north side of the site and vehicles will circulate the site in a counterclockwise direction with queues extending along the north, west, and south sides of the site.

In order to determine the projected peak stacking of vehicles, observations were conducted at two existing 7 Brew locations in Naperville in March 2025 and Lake Zurich in May 2025 during the hours of operation on Thursday, Friday, Saturday, and Sunday. The results of the observations indicated that the peak observed queuing at the Naperville location was 71 vehicles, which occurred Sunday at 4:30 P.M., and the peak queue observed at the Lake Zurich location was 45 vehicles, which occurred on Saturday at 3:15 P.M.

However, it should be noted that the current queues resulting at the Naperville and Lake Zurich locations (as well as other Chicagoland locations) are a result of 7 Brew coffee shops being new to the Chicagoland region with only four locations open as of July 2025 and the popularity of the product in this market. Therefore, as more 7 Brew locations are constructed, the trips generated and on-site queuing by the Chicagoland locations will reduce and stabilize. As of July 2025, there are 13 other approved or under construction 7 Brew locations with the closest locations in Joliet, Lockport, Bolingbrook, and Bloomingdale with numerous other locations planned.

As such, to determine what the queue of the proposed 7 Brew location will be in the future when additional locations are constructed and the Chicagoland market has stabilized, KLOA Inc. reviewed the following:

- A 7 Brew operations memorandum prepared by Stonefield Engineering and Design, LLC, dated October 15, 2024, for an established 7 Brew location in Sinking Spring, Pennsylvania.
- Sales and zip code data for the Naperville and Lake Zurich locations and three other national average established 7 Brew locations.

7 Brew Observation Technical Memorandum

In this memorandum, Stonefield Engineering and Design, LLC conducted operational observations at the existing 7 Brew location at 3582 Penn Avenue in Sinking Spring, Pennsylvania during peak activities of the store on a Friday and Saturday in April 2024. It should be noted that there are only two 7 Brew locations within this area with the other store located approximately six miles from the study location. The following summarizes the key findings of the observations:

- The average transaction time during the review period ranged from three minutes and 44 seconds to four minutes and 36 seconds, with a maximum transaction time of 15 minutes and 23 seconds.
- The maximum queue observed during the review period was 15 vehicles, with an average queue of 10 vehicles.

Sales and Zip Code Data for 7 Brew Locations

The existing sales volume of the Naperville and Lake Zurich 7 Brew locations were compared to the following three established 7 Brew locations nationally:

- 217 N. Thompson Lane in Murfreesboro, Tennessee 37129
- 1815 N. Main Street in Shelbyville, Tennessee 37160
- 552 Island Ford Road in Madisonville, Kentucky 42431

The sales and transaction data for the four locations over a two-week period was reviewed. The review of the data indicates the following:

- Weekly sales at the national average locations were approximately 53 to 58 percent less than the Naperville location.
- While the Monday through Thursday sales at the national average locations are consistent with the Lake Zurich location, on Friday through Sunday the sales at the national average locations are 13 to 22 percent less than the Lake Zurich location.

- On a weekly basis, the national average locations have approximately 56 percent less sales than the Naperville location and ten percent less sales than the Lake Zurich location.

In addition to the transaction data, the zip code origins of Naperville and Lake Zurich customers over a two-week period were compared to the three national average locations. The following summarizes the comparison of the data:

- At the Naperville location, one percent of customers originate within one mile, four percent originate between one and two miles, 15 percent originate within two and five miles, 25 percent originate within five to ten miles, and 55 percent originate over 10 miles from the location (80 percent over five miles).
- At the Lake Zurich location, five percent of customers originate within one mile, three percent originate between one and two miles, 16 percent originate within two and five miles, 40 percent originate within five to ten miles, and 36 percent originate over 10 miles from the location (76 percent over five miles).
- At the three established locations on average, five percent of customers originate within one mile, 13 percent originate between one and two miles, 30 percent originate within two and five miles, 16 percent originate within five to ten miles, and 36 percent originate over 10 miles from the location (52 percent over five miles).
- As previously indicated, there are currently 13 other approved or under construction 7 Brew locations in the Chicagoland area.
 - Four of the approved locations are expected to result in at least 13 to 16 percent reduction in sales at the Naperville location.
 - Three approved 7 Brew locations are expected to result in an approximately 14 to 18 percent reduction in sales at the Lake Zurich location.

Estimated Peak Queue Reductions

As can be seen from the above, the Naperville and Lake Zurich locations are pulling a higher percentage of customers from a wider trade area than the other three national average locations which are resulting in higher trip generation, vehicle queueing, and sales compared to national average locations.

Therefore, it is anticipated that with the opening of the Downers Grove location and the previously identified and soon to be constructed locations (13 total) and when sales at the existing locations become more reflective of a national average location, the peak queues are projected to be reduced as follows:

- The Naperville peak queue is anticipated to be reduced by at least 53 percent. As such, the peak queue for the Naperville location in a stabilized market is estimated to be 33 vehicles.

- The Lake Zurich peak queue is anticipated to be reduced by 25 to 30 percent. As such, the peak queue for the Lake Zurich location in a stabilized market is estimated to be 31 to 34 vehicles.

As previously indicated, approximately 55 percent and 36 percent of sales at the Naperville and Lake Zurich locations, respectively, have zip codes greater than ten miles from each location. Of which, approximately 49 percent and 31 percent are within a radius of 10 to 30 miles, respectively. When the percentages for this radius are compared to the sale of the national average locations, an average of 25 percent of sales occur within this radius. Therefore, it is anticipated that the peak queues are anticipated to be further reduced.

Therefore, to mitigate the peak queues estimated for the proposed 7 Brew location, the site has been designed to provide stacking for 39 vehicles within the drive-thru lanes. In the event that peak queues extend beyond the proposed 39 vehicle stacking, additional vehicles can stack within the retail center parking lot without impacting the access system serving the retail center or the proximate parking spaces to the Golf Galaxy and Best Buy main entrances. As such, the proposed stacking will be able to accommodate the estimated peak queue of 33 to 34 vehicles based on surveys conducted at existing 7 Brew locations and a review of sales data available for the existing two locations and three national average locations.

Parking Evaluation

As previously indicated, the proposed 7 Brew will be an outlot parcel for the Golf Galaxy and Best Buy shopping center. The Best Buy is approximately 69,000 square feet and the Golf Galaxy space is approximately 39,000 square feet. Upon buildout of the 7 Brew, the shopping center will provide 320 parking spaces. In order to determine the adequacy of the proposed parking supply, parking rates published in the Institute of Transportation Engineers' (ITE) *Parking Generation Manual*, 6th Edition were reviewed.

- Electronic Superstores (Land-Use Code 863) experience an average peak parking demand of 1.65 spaces per 1,000 square feet. As such, the Best Buy has an estimated peak parking demand of 114 spaces
- Sporting Good Superstores (Land-Use Code 861) experience an average peak parking demand 2.18 spaces per 1,000 square feet. As such, the Golf Galaxy has an estimated peak parking demand of 85 parking spaces.

As such, the two stores combined have an estimated peak parking demand of 199 spaces, which can be accommodated by the 320 parking spaces provided.

6. Conclusion

Based on the preceding analyses and recommendations, the following conclusions have been made:

- The volume of traffic estimated to be generated by 7 Brew, based on surveys conducted at the Lake Zurich location, will have a limited impact on the available capacity of the access system serving the shopping center.
- It is anticipated that with additional 7 Brew locations built in the Chicagoland region, the existing trip generation and queueing as surveyed at the Naperville and Lake Zurich locations will be reduced.
- Access to the site will be provided via the existing access system serving the retail center which primarily consists of a full movement access road off Downers Drive and a right-in/right-out access drive off Butterfield Road.
- Based on a review of queueing surveys conducted at the Naperville and Lake Zurich 7 Brew locations, and sales/zip code information for the Naperville and Lake Zurich locations and three national average locations, it is anticipated that the peak queue for the subject 7 Brew site will be up to 34 vehicles.
- The proposed stacking for 39 vehicles within the drive-thru lanes and emergency stacking within the retail center parking lot will provide more than adequate stacking to accommodate the peak queue projected for the subject 7 Brew location.
- The resulting 320 parking spaces serving Golf Galaxy and Best Buy will be adequate in accommodating the estimated peak parking demands for the stores based on information published in the ITE *Parking Generation Manual*, 6th Edition.

Appendix

Traffic Count Summary Sheets

Site Plan

ITE Trip Generation Sheets

CMAP 2050 Projections Letter

Level of Service Criteria

Capacity Analysis Summary Sheets

Traffic Count Summary Sheets



Kenig Lindgren O'Hara Aboona, Inc.
9575 W. Higgins Rd., Suite 400

Rosemont, Illinois, United States 60018
(847)518-9990 dfreeman@kloainc.com

Count Name: Butterfield Road with Downers Drive TMC
Site Code:
Start Date: 08/07/2025
Page No: 1

Turning Movement Data

Start Time	Butterfield Road Eastbound						Butterfield Road Westbound						Downers Drive Northbound						Downers Drive Southbound						Int. Total
	U-Turn	Left	Thru	Right	Peds	App. Total	U-Turn	Left	Thru	Right	Peds	App. Total	U-Turn	Left	Thru	Right	Peds	App. Total	U-Turn	Left	Thru	Right	Peds	App. Total	
7:00 AM	0	20	284	12	0	316	1	47	202	33	0	283	0	5	1	1	0	7	0	11	3	10	0	24	630
7:15 AM	0	9	348	14	0	371	1	70	259	28	0	358	0	4	6	0	0	10	0	18	11	8	0	37	776
7:30 AM	0	24	369	28	0	421	0	79	270	38	0	387	0	3	2	6	0	11	0	17	9	8	0	34	853
7:45 AM	0	26	416	37	0	479	0	91	335	58	1	484	0	2	2	13	0	17	0	13	11	4	0	28	1008
Hourly Total	0	79	1417	91	0	1587	2	287	1066	157	1	1512	0	14	11	20	0	45	0	59	34	30	0	123	3267
8:00 AM	1	16	397	40	0	454	0	77	303	62	0	442	0	4	2	7	0	13	0	21	9	8	0	38	947
8:15 AM	0	16	408	47	0	471	0	104	271	36	2	411	0	5	3	4	0	12	0	15	8	10	0	33	927
8:30 AM	0	13	406	34	0	453	0	80	304	34	0	418	0	8	6	9	0	23	0	37	4	12	0	53	947
8:45 AM	2	25	363	30	0	420	2	99	287	38	0	426	0	11	4	6	0	21	0	31	6	14	0	51	918
Hourly Total	3	70	1574	151	0	1798	2	360	1165	170	2	1697	0	28	15	26	0	69	0	104	27	44	0	175	3739
*** BREAK ***	-	-	-	-	-	-	-	-	-	-	-	-	-	-	-	-	-	-	-	-	-	-	-	-	-
4:00 PM	4	27	360	29	0	420	2	210	429	52	0	693	0	17	6	18	0	41	0	64	28	45	0	137	1291
4:15 PM	0	24	354	24	0	402	1	179	482	56	0	718	0	21	10	15	0	46	0	67	24	29	1	120	1286
4:30 PM	2	25	315	29	0	371	0	177	442	60	0	679	0	18	5	31	0	54	0	89	23	40	0	152	1256
4:45 PM	0	12	385	34	0	431	1	168	487	67	0	723	0	23	11	30	0	64	0	70	17	31	0	118	1336
Hourly Total	6	88	1414	116	0	1624	4	734	1840	235	0	2813	0	79	32	94	0	205	0	290	92	145	1	527	5169
5:00 PM	3	21	427	12	0	463	3	214	484	39	0	740	0	36	5	29	0	70	0	58	9	30	0	97	1370
5:15 PM	1	35	370	27	0	433	2	218	450	64	0	734	0	22	8	24	0	54	0	61	17	23	0	101	1322
5:30 PM	2	18	400	11	2	431	1	131	385	50	0	567	0	12	6	12	0	30	0	71	13	28	0	112	1140
5:45 PM	2	31	431	25	0	489	2	145	417	52	0	616	0	16	2	14	0	32	0	71	3	30	0	104	1241
Hourly Total	8	105	1628	75	2	1816	8	708	1736	205	0	2657	0	86	21	79	0	186	0	261	42	111	0	414	5073
*** BREAK ***	-	-	-	-	-	-	-	-	-	-	-	-	-	-	-	-	-	-	-	-	-	-	-	-	-
12:00 PM	0	34	272	21	0	327	6	93	299	99	0	497	0	9	7	11	0	27	0	78	13	25	0	116	967
12:15 PM	1	28	250	16	0	295	4	112	351	77	0	544	0	14	7	10	0	31	0	84	16	28	0	128	998
12:30 PM	0	35	282	13	0	330	6	109	278	65	0	458	0	8	3	15	0	26	0	62	12	31	0	105	919
12:45 PM	0	26	237	13	0	276	7	127	270	96	0	500	0	19	7	7	0	33	0	92	16	34	0	142	951
Hourly Total	1	123	1041	63	0	1228	23	441	1198	337	0	1999	0	50	24	43	0	117	0	316	57	118	0	491	3835
1:00 PM	0	41	304	8	0	353	6	95	336	85	1	522	0	8	8	7	0	23	0	64	17	34	0	115	1013
1:15 PM	0	38	274	11	0	323	3	107	345	88	0	543	0	14	7	9	0	30	0	70	17	40	0	127	1023
1:30 PM	2	25	280	4	0	311	5	97	331	89	0	522	0	12	11	6	0	29	1	72	16	48	0	137	999
1:45 PM	0	38	299	5	0	342	4	93	335	77	0	509	0	18	8	16	0	42	0	76	15	39	0	130	1023
Hourly Total	2	142	1157	28	0	1329	18	392	1347	339	1	2096	0	52	34	38	0	124	1	282	65	161	0	509	4058
Grand Total	20	607	8231	524	2	9382	57	2922	8352	1443	4	12774	0	309	137	300	0	746	1	1312	317	609	1	2239	25141
Approach %	0.2	6.5	87.7	5.6	-	-	0.4	22.9	65.4	11.3	-	-	0.0	41.4	18.4	40.2	-	-	0.0	58.6	14.2	27.2	-	-	-
Total %	0.1	2.4	32.7	2.1	-	37.3	0.2	11.6	33.2	5.7	-	50.8	0.0	1.2	0.5	1.2	-	3.0	0.0	5.2	1.3	2.4	-	8.9	-

Lights	20	597	8095	521	-	9233	55	2858	8228	1436	-	12577	0	309	136	298	-	743	1	1299	313	600	-	2213	24766
% Lights	100.0	98.4	98.3	99.4	-	98.4	96.5	97.8	98.5	99.5	-	98.5	-	100.0	99.3	99.3	-	99.6	100.0	99.0	98.7	98.5	-	98.8	98.5
Buses	0	0	31	0	-	31	0	29	7	1	-	37	0	0	0	0	-	0	0	0	0	0	-	0	68
% Buses	0.0	0.0	0.4	0.0	-	0.3	0.0	1.0	0.1	0.1	-	0.3	-	0.0	0.0	0.0	-	0.0	0.0	0.0	0.0	0.0	-	0.0	0.3
Single-Unit Trucks	0	6	78	1	-	85	1	24	88	4	-	117	0	0	1	1	-	2	0	9	1	2	-	12	216
% Single-Unit Trucks	0.0	1.0	0.9	0.2	-	0.9	1.8	0.8	1.1	0.3	-	0.9	-	0.0	0.7	0.3	-	0.3	0.0	0.7	0.3	0.3	-	0.5	0.9
Articulated Trucks	0	4	27	2	-	33	1	11	29	2	-	43	0	0	0	1	-	1	0	4	3	6	-	13	90
% Articulated Trucks	0.0	0.7	0.3	0.4	-	0.4	1.8	0.4	0.3	0.1	-	0.3	-	0.0	0.0	0.3	-	0.1	0.0	0.3	0.9	1.0	-	0.6	0.4
Bicycles on Road	0	0	0	0	-	0	0	0	0	0	-	0	0	0	0	0	-	0	0	0	0	1	-	1	1
% Bicycles on Road	0.0	0.0	0.0	0.0	-	0.0	0.0	0.0	0.0	0.0	-	0.0	-	0.0	0.0	0.0	-	0.0	0.0	0.0	0.0	0.2	-	0.0	0.0
Pedestrians	-	-	-	-	2	-	-	-	-	-	4	-	-	-	-	-	0	-	-	-	-	-	1	-	-
% Pedestrians	-	-	-	-	100.0	-	-	-	-	-	100.0	-	-	-	-	-	-	-	-	-	-	-	100.0	-	-



Kenig Lindgren O'Hara Aboona, Inc.
9575 W. Higgins Rd., Suite 400

Rosemont, Illinois, United States 60018
(847)518-9990 dfreeman@kloainc.com

Count Name: Butterfield Road with Downers Drive TMC
Site Code:
Start Date: 08/07/2025
Page No: 3

Turning Movement Peak Hour Data (7:45 AM)

Start Time	Butterfield Road Eastbound						Butterfield Road Westbound						Downers Drive Northbound						Downers Drive Southbound						Int. Total
	U-Turn	Left	Thru	Right	Peds	App. Total	U-Turn	Left	Thru	Right	Peds	App. Total	U-Turn	Left	Thru	Right	Peds	App. Total	U-Turn	Left	Thru	Right	Peds	App. Total	
7:45 AM	0	26	416	37	0	479	0	91	335	58	1	484	0	2	2	13	0	17	0	13	11	4	0	28	1008
8:00 AM	1	16	397	40	0	454	0	77	303	62	0	442	0	4	2	7	0	13	0	21	9	8	0	38	947
8:15 AM	0	16	408	47	0	471	0	104	271	36	2	411	0	5	3	4	0	12	0	15	8	10	0	33	927
8:30 AM	0	13	406	34	0	453	0	80	304	34	0	418	0	8	6	9	0	23	0	37	4	12	0	53	947
Total	1	71	1627	158	0	1857	0	352	1213	190	3	1755	0	19	13	33	0	65	0	86	32	34	0	152	3829
Approach %	0.1	3.8	87.6	8.5	-	-	0.0	20.1	69.1	10.8	-	-	0.0	29.2	20.0	50.8	-	-	0.0	56.6	21.1	22.4	-	-	-
Total %	0.0	1.9	42.5	4.1	-	48.5	0.0	9.2	31.7	5.0	-	45.8	0.0	0.5	0.3	0.9	-	1.7	0.0	2.2	0.8	0.9	-	4.0	-
PHF	0.250	0.683	0.978	0.840	-	0.969	0.000	0.846	0.905	0.766	-	0.907	0.000	0.594	0.542	0.635	-	0.707	0.000	0.581	0.727	0.708	-	0.717	0.950
Lights	1	69	1595	157	-	1822	0	340	1175	186	-	1701	0	19	12	32	-	63	0	83	31	31	-	145	3731
% Lights	100.0	97.2	98.0	99.4	-	98.1	-	96.6	96.9	97.9	-	96.9	-	100.0	92.3	97.0	-	96.9	-	96.5	96.9	91.2	-	95.4	97.4
Buses	0	0	6	0	-	6	0	8	0	0	-	8	0	0	0	0	-	0	0	0	0	0	-	0	14
% Buses	0.0	0.0	0.4	0.0	-	0.3	-	2.3	0.0	0.0	-	0.5	-	0.0	0.0	0.0	-	0.0	-	0.0	0.0	0.0	-	0.0	0.4
Single-Unit Trucks	0	1	19	0	-	20	0	3	29	3	-	35	0	0	1	0	-	1	0	3	0	1	-	4	60
% Single-Unit Trucks	0.0	1.4	1.2	0.0	-	1.1	-	0.9	2.4	1.6	-	2.0	-	0.0	7.7	0.0	-	1.5	-	3.5	0.0	2.9	-	2.6	1.6
Articulated Trucks	0	1	7	1	-	9	0	1	9	1	-	11	0	0	0	1	-	1	0	0	1	2	-	3	24
% Articulated Trucks	0.0	1.4	0.4	0.6	-	0.5	-	0.3	0.7	0.5	-	0.6	-	0.0	0.0	3.0	-	1.5	-	0.0	3.1	5.9	-	2.0	0.6
Bicycles on Road	0	0	0	0	-	0	0	0	0	0	-	0	0	0	0	0	-	0	0	0	0	0	-	0	0
% Bicycles on Road	0.0	0.0	0.0	0.0	-	0.0	-	0.0	0.0	0.0	-	0.0	-	0.0	0.0	0.0	-	0.0	-	0.0	0.0	0.0	-	0.0	0.0
Pedestrians	-	-	-	-	0	-	-	-	-	-	3	-	-	-	-	-	0	-	-	-	-	-	0	-	-
% Pedestrians	-	-	-	-	-	-	-	-	-	-	100.0	-	-	-	-	-	-	-	-	-	-	-	-	-	-



Kenig Lindgren O'Hara Aboona, Inc.
9575 W. Higgins Rd., Suite 400

Rosemont, Illinois, United States 60018
(847)518-9990 dfreeman@kloainc.com

Count Name: Butterfield Road with Downers Drive TMC
Site Code:
Start Date: 08/07/2025
Page No: 4

Turning Movement Peak Hour Data (4:30 PM)

Start Time	Butterfield Road Eastbound						Butterfield Road Westbound						Downers Drive Northbound						Downers Drive Southbound						Int. Total
	U-Turn	Left	Thru	Right	Peds	App. Total	U-Turn	Left	Thru	Right	Peds	App. Total	U-Turn	Left	Thru	Right	Peds	App. Total	U-Turn	Left	Thru	Right	Peds	App. Total	
4:30 PM	2	25	315	29	0	371	0	177	442	60	0	679	0	18	5	31	0	54	0	89	23	40	0	152	1256
4:45 PM	0	12	385	34	0	431	1	168	487	67	0	723	0	23	11	30	0	64	0	70	17	31	0	118	1336
5:00 PM	3	21	427	12	0	463	3	214	484	39	0	740	0	36	5	29	0	70	0	58	9	30	0	97	1370
5:15 PM	1	35	370	27	0	433	2	218	450	64	0	734	0	22	8	24	0	54	0	61	17	23	0	101	1322
Total	6	93	1497	102	0	1698	6	777	1863	230	0	2876	0	99	29	114	0	242	0	278	66	124	0	468	5284
Approach %	0.4	5.5	88.2	6.0	-	-	0.2	27.0	64.8	8.0	-	-	0.0	40.9	12.0	47.1	-	-	0.0	59.4	14.1	26.5	-	-	-
Total %	0.1	1.8	28.3	1.9	-	32.1	0.1	14.7	35.3	4.4	-	54.4	0.0	1.9	0.5	2.2	-	4.6	0.0	5.3	1.2	2.3	-	8.9	-
PHF	0.500	0.664	0.876	0.750	-	0.917	0.500	0.891	0.956	0.858	-	0.972	0.000	0.688	0.659	0.919	-	0.864	0.000	0.781	0.717	0.775	-	0.770	0.964
Lights	6	90	1466	101	-	1663	6	762	1845	230	-	2843	0	99	29	114	-	242	0	276	64	123	-	463	5211
% Lights	100.0	96.8	97.9	99.0	-	97.9	100.0	98.1	99.0	100.0	-	98.9	-	100.0	100.0	100.0	-	100.0	-	99.3	97.0	99.2	-	98.9	98.6
Buses	0	0	7	0	-	7	0	9	0	0	-	9	0	0	0	0	-	0	0	0	0	0	-	0	16
% Buses	0.0	0.0	0.5	0.0	-	0.4	0.0	1.2	0.0	0.0	-	0.3	-	0.0	0.0	0.0	-	0.0	-	0.0	0.0	0.0	-	0.0	0.3
Single-Unit Trucks	0	3	19	0	-	22	0	4	12	0	-	16	0	0	0	0	-	0	0	1	1	0	-	2	40
% Single-Unit Trucks	0.0	3.2	1.3	0.0	-	1.3	0.0	0.5	0.6	0.0	-	0.6	-	0.0	0.0	0.0	-	0.0	-	0.4	1.5	0.0	-	0.4	0.8
Articulated Trucks	0	0	5	1	-	6	0	2	6	0	-	8	0	0	0	0	-	0	0	1	1	1	-	3	17
% Articulated Trucks	0.0	0.0	0.3	1.0	-	0.4	0.0	0.3	0.3	0.0	-	0.3	-	0.0	0.0	0.0	-	0.0	-	0.4	1.5	0.8	-	0.6	0.3
Bicycles on Road	0	0	0	0	-	0	0	0	0	0	-	0	0	0	0	0	-	0	0	0	0	0	-	0	0
% Bicycles on Road	0.0	0.0	0.0	0.0	-	0.0	0.0	0.0	0.0	0.0	-	0.0	-	0.0	0.0	0.0	-	0.0	-	0.0	0.0	0.0	-	0.0	0.0
Pedestrians	-	-	-	-	0	-	-	-	-	-	0	-	-	-	-	-	0	-	-	-	-	-	0	-	-
% Pedestrians	-	-	-	-	-	-	-	-	-	-	-	-	-	-	-	-	-	-	-	-	-	-	-	-	-



Kenig Lindgren O'Hara Aboona, Inc.
9575 W. Higgins Rd., Suite 400

Rosemont, Illinois, United States 60018
(847)518-9990 dfreeman@kloainc.com

Count Name: Butterfield Road with Downers Drive TMC
Site Code:
Start Date: 08/07/2025
Page No: 5

Turning Movement Peak Hour Data (1:00 PM)

Start Time	Butterfield Road Eastbound						Butterfield Road Westbound						Downers Drive Northbound						Downers Drive Southbound						Int. Total
	U-Turn	Left	Thru	Right	Peds	App. Total	U-Turn	Left	Thru	Right	Peds	App. Total	U-Turn	Left	Thru	Right	Peds	App. Total	U-Turn	Left	Thru	Right	Peds	App. Total	
1:00 PM	0	41	304	8	0	353	6	95	336	85	1	522	0	8	8	7	0	23	0	64	17	34	0	115	1013
1:15 PM	0	38	274	11	0	323	3	107	345	88	0	543	0	14	7	9	0	30	0	70	17	40	0	127	1023
1:30 PM	2	25	280	4	0	311	5	97	331	89	0	522	0	12	11	6	0	29	1	72	16	48	0	137	999
1:45 PM	0	38	299	5	0	342	4	93	335	77	0	509	0	18	8	16	0	42	0	76	15	39	0	130	1023
Total	2	142	1157	28	0	1329	18	392	1347	339	1	2096	0	52	34	38	0	124	1	282	65	161	0	509	4058
Approach %	0.2	10.7	87.1	2.1	-	-	0.9	18.7	64.3	16.2	-	-	0.0	41.9	27.4	30.6	-	-	0.2	55.4	12.8	31.6	-	-	-
Total %	0.0	3.5	28.5	0.7	-	32.8	0.4	9.7	33.2	8.4	-	51.7	0.0	1.3	0.8	0.9	-	3.1	0.0	6.9	1.6	4.0	-	12.5	-
PHF	0.250	0.866	0.951	0.636	-	0.941	0.750	0.916	0.976	0.952	-	0.965	0.000	0.722	0.773	0.594	-	0.738	0.250	0.928	0.956	0.839	-	0.929	0.992
Lights	2	141	1150	28	-	1321	18	387	1331	338	-	2074	0	52	34	37	-	123	1	279	64	160	-	504	4022
% Lights	100.0	99.3	99.4	100.0	-	99.4	100.0	98.7	98.8	99.7	-	99.0	-	100.0	100.0	97.4	-	99.2	100.0	98.9	98.5	99.4	-	99.0	99.1
Buses	0	0	4	0	-	4	0	2	3	0	-	5	0	0	0	0	-	0	0	0	0	0	-	0	9
% Buses	0.0	0.0	0.3	0.0	-	0.3	0.0	0.5	0.2	0.0	-	0.2	-	0.0	0.0	0.0	-	0.0	0.0	0.0	0.0	0.0	-	0.0	0.2
Single-Unit Trucks	0	0	1	0	-	1	0	3	12	0	-	15	0	0	0	1	-	1	0	1	0	0	-	1	18
% Single-Unit Trucks	0.0	0.0	0.1	0.0	-	0.1	0.0	0.8	0.9	0.0	-	0.7	-	0.0	0.0	2.6	-	0.8	0.0	0.4	0.0	0.0	-	0.2	0.4
Articulated Trucks	0	1	2	0	-	3	0	0	1	1	-	2	0	0	0	0	-	0	0	2	1	0	-	3	8
% Articulated Trucks	0.0	0.7	0.2	0.0	-	0.2	0.0	0.0	0.1	0.3	-	0.1	-	0.0	0.0	0.0	-	0.0	0.0	0.7	1.5	0.0	-	0.6	0.2
Bicycles on Road	0	0	0	0	-	0	0	0	0	0	-	0	0	0	0	0	-	0	0	0	0	1	-	1	1
% Bicycles on Road	0.0	0.0	0.0	0.0	-	0.0	0.0	0.0	0.0	0.0	-	0.0	-	0.0	0.0	0.0	-	0.0	0.0	0.0	0.0	0.6	-	0.2	0.0
Pedestrians	-	-	-	-	0	-	-	-	-	-	1	-	-	-	-	-	0	-	-	-	-	-	0	-	-
% Pedestrians	-	-	-	-	-	-	-	-	-	-	100.0	-	-	-	-	-	-	-	-	-	-	-	-	-	-



Kenig Lindgren O'Hara Aboona, Inc.
9575 W. Higgins Rd., Suite 400

Rosemont, Illinois, United States 60018
(847)518-9990 dfreeman@kloainc.com

Count Name: Downers Drive with Access Drive
TMC
Site Code:
Start Date: 08/07/2025
Page No: 1

Turning Movement Data

Start Time	Access Drive Eastbound						Access Drive Westbound						Downers Drive Northbound						Downers Drive Southbound						Int. Total
	U-Turn	Left	Thru	Right	Peds	App. Total	U-Turn	Left	Thru	Right	Peds	App. Total	U-Turn	Left	Thru	Right	Peds	App. Total	U-Turn	Left	Thru	Right	Peds	App. Total	
7:00 AM	0	1	1	16	0	18	0	4	2	2	0	8	0	29	18	7	0	54	0	0	11	0	0	11	91
7:15 AM	0	2	2	25	0	29	0	2	1	1	0	4	0	31	12	0	0	43	0	0	5	0	0	5	81
7:30 AM	0	2	3	27	0	32	0	7	0	1	0	8	1	42	12	9	0	64	0	0	5	0	0	5	109
7:45 AM	0	5	2	25	0	32	0	6	2	0	0	8	0	61	21	6	1	88	0	0	3	0	0	3	131
Hourly Total	0	10	8	93	0	111	0	19	5	4	0	28	1	163	63	22	1	249	0	0	24	0	0	24	412
8:00 AM	0	2	3	29	0	34	0	3	3	0	0	6	0	61	20	3	0	84	0	0	5	0	0	5	129
8:15 AM	0	3	1	30	0	34	0	3	3	0	0	6	0	34	15	5	0	54	0	0	5	1	0	6	100
8:30 AM	0	1	4	37	0	42	0	7	0	3	0	10	0	32	14	10	0	56	0	1	5	2	0	8	116
8:45 AM	0	2	8	46	0	56	0	10	3	1	0	14	0	41	10	9	0	60	0	0	5	3	0	8	138
Hourly Total	0	8	16	142	0	166	0	23	9	4	0	36	0	168	59	27	0	254	0	1	20	6	0	27	483
*** BREAK ***	-	-	-	-	-	-	-	-	-	-	-	-	-	-	-	-	-	-	-	-	-	-	-	-	-
4:00 PM	0	2	15	53	0	70	0	45	21	3	0	69	0	64	2	18	0	84	0	2	34	0	2	36	259
4:15 PM	0	0	14	68	0	82	0	38	18	4	0	60	0	62	7	20	0	89	0	1	18	1	1	20	251
4:30 PM	0	1	14	70	0	85	0	41	10	4	0	55	1	61	9	13	0	84	0	1	26	4	2	31	255
4:45 PM	0	0	11	61	0	72	0	40	12	1	0	53	0	69	2	21	0	92	0	2	18	0	2	20	237
Hourly Total	0	3	54	252	0	309	0	164	61	12	0	237	1	256	20	72	0	349	0	6	96	5	7	107	1002
5:00 PM	0	1	13	58	0	72	0	33	15	5	0	53	0	41	6	10	1	57	0	2	22	0	0	24	206
5:15 PM	0	1	17	52	1	70	0	27	8	2	0	37	1	70	7	31	0	109	0	2	17	3	1	22	238
5:30 PM	0	0	12	68	0	80	0	37	19	2	0	58	0	60	5	20	0	85	0	0	14	1	1	15	238
5:45 PM	0	0	10	60	0	70	0	39	18	1	0	58	0	45	1	27	0	73	0	1	6	0	0	7	208
Hourly Total	0	2	52	238	1	292	0	136	60	10	0	206	1	216	19	88	1	324	0	5	59	4	2	68	890
*** BREAK ***	-	-	-	-	-	-	-	-	-	-	-	-	-	-	-	-	-	-	-	-	-	-	-	-	-
12:00 PM	0	1	21	62	0	84	0	55	14	1	0	70	0	91	3	36	0	130	0	0	4	0	1	4	288
12:15 PM	0	0	19	71	0	90	0	48	12	4	0	64	0	80	1	25	0	106	0	0	1	1	2	2	262
12:30 PM	0	0	24	63	0	87	0	46	16	4	0	66	0	65	1	33	0	99	0	1	4	1	1	6	258
12:45 PM	0	1	19	81	0	101	0	56	12	2	0	70	0	94	3	32	0	129	0	2	3	1	3	6	306
Hourly Total	0	2	83	277	0	362	0	205	54	11	0	270	0	330	8	126	0	464	0	3	12	3	7	18	1114
1:00 PM	0	2	30	74	0	106	0	48	19	4	0	71	0	74	2	37	0	113	0	1	1	3	3	5	295
1:15 PM	0	1	18	82	0	101	0	45	20	4	0	69	1	91	3	42	0	137	0	2	3	1	0	6	313
1:30 PM	0	1	32	76	0	109	0	60	17	3	0	80	0	88	3	36	0	127	0	0	4	0	3	4	320
1:45 PM	0	1	16	78	0	95	0	53	17	6	0	76	0	87	0	33	0	120	0	0	2	2	2	4	295
Hourly Total	0	5	96	310	0	411	0	206	73	17	0	296	1	340	8	148	0	497	0	3	10	6	8	19	1223
Grand Total	0	30	309	1312	1	1651	0	753	262	58	0	1073	4	1473	177	483	2	2137	0	18	221	24	24	263	5124
Approach %	0.0	1.8	18.7	79.5	-	-	0.0	70.2	24.4	5.4	-	-	0.2	68.9	8.3	22.6	-	-	0.0	6.8	84.0	9.1	-	-	-
Total %	0.0	0.6	6.0	25.6	-	32.2	0.0	14.7	5.1	1.1	-	20.9	0.1	28.7	3.5	9.4	-	41.7	0.0	0.4	4.3	0.5	-	5.1	-

Lights	0	30	309	1309	-	1648	0	750	262	58	-	1070	4	1468	164	481	-	2117	0	18	200	24	-	242	5077
% Lights	-	100.0	100.0	99.8	-	99.8	-	99.6	100.0	100.0	-	99.7	100.0	99.7	92.7	99.6	-	99.1	-	100.0	90.5	100.0	-	92.0	99.1
Buses	0	0	0	0	-	0	0	0	0	0	-	0	0	1	0	0	-	1	0	0	0	0	-	0	1
% Buses	-	0.0	0.0	0.0	-	0.0	-	0.0	0.0	0.0	-	0.0	0.0	0.1	0.0	0.0	-	0.0	-	0.0	0.0	0.0	-	0.0	0.0
Single-Unit Trucks	0	0	0	3	-	3	0	2	0	0	-	2	0	4	4	2	-	10	0	0	14	0	-	14	29
% Single-Unit Trucks	-	0.0	0.0	0.2	-	0.2	-	0.3	0.0	0.0	-	0.2	0.0	0.3	2.3	0.4	-	0.5	-	0.0	6.3	0.0	-	5.3	0.6
Articulated Trucks	0	0	0	0	-	0	0	1	0	0	-	1	0	0	9	0	-	9	0	0	7	0	-	7	17
% Articulated Trucks	-	0.0	0.0	0.0	-	0.0	-	0.1	0.0	0.0	-	0.1	0.0	0.0	5.1	0.0	-	0.4	-	0.0	3.2	0.0	-	2.7	0.3
Bicycles on Road	0	0	0	0	-	0	0	0	0	0	-	0	0	0	0	0	-	0	0	0	0	0	-	0	0
% Bicycles on Road	-	0.0	0.0	0.0	-	0.0	-	0.0	0.0	0.0	-	0.0	0.0	0.0	0.0	0.0	-	0.0	-	0.0	0.0	0.0	-	0.0	0.0
Pedestrians	-	-	-	-	1	-	-	-	-	-	0	-	-	-	-	-	2	-	-	-	-	-	24	-	-
% Pedestrians	-	-	-	-	100.0	-	-	-	-	-	-	-	-	-	-	-	100.0	-	-	-	-	-	100.0	-	-



Kenig Lindgren O'Hara Aboona, Inc.
9575 W. Higgins Rd., Suite 400

Rosemont, Illinois, United States 60018
(847)518-9990 dfreeman@kloainc.com

Count Name: Downers Drive with Access Drive
TMC
Site Code:
Start Date: 08/07/2025
Page No: 3

Turning Movement Peak Hour Data (7:45 AM)

Start Time	Access Drive Eastbound						Access Drive Westbound						Downers Drive Northbound						Downers Drive Southbound						Int. Total
	U-Turn	Left	Thru	Right	Peds	App. Total	U-Turn	Left	Thru	Right	Peds	App. Total	U-Turn	Left	Thru	Right	Peds	App. Total	U-Turn	Left	Thru	Right	Peds	App. Total	
7:45 AM	0	5	2	25	0	32	0	6	2	0	0	8	0	61	21	6	1	88	0	0	3	0	0	3	131
8:00 AM	0	2	3	29	0	34	0	3	3	0	0	6	0	61	20	3	0	84	0	0	5	0	0	5	129
8:15 AM	0	3	1	30	0	34	0	3	3	0	0	6	0	34	15	5	0	54	0	0	5	1	0	6	100
8:30 AM	0	1	4	37	0	42	0	7	0	3	0	10	0	32	14	10	0	56	0	1	5	2	0	8	116
Total	0	11	10	121	0	142	0	19	8	3	0	30	0	188	70	24	1	282	0	1	18	3	0	22	476
Approach %	0.0	7.7	7.0	85.2	-	-	0.0	63.3	26.7	10.0	-	-	0.0	66.7	24.8	8.5	-	-	0.0	4.5	81.8	13.6	-	-	-
Total %	0.0	2.3	2.1	25.4	-	29.8	0.0	4.0	1.7	0.6	-	6.3	0.0	39.5	14.7	5.0	-	59.2	0.0	0.2	3.8	0.6	-	4.6	-
PHF	0.000	0.550	0.625	0.818	-	0.845	0.000	0.679	0.667	0.250	-	0.750	0.000	0.770	0.833	0.600	-	0.801	0.000	0.250	0.900	0.375	-	0.688	0.908
Lights	0	11	10	120	-	141	0	19	8	3	-	30	0	185	64	24	-	273	0	1	12	3	-	16	460
% Lights	-	100.0	100.0	99.2	-	99.3	-	100.0	100.0	100.0	-	100.0	-	98.4	91.4	100.0	-	96.8	-	100.0	66.7	100.0	-	72.7	96.6
Buses	0	0	0	0	-	0	0	0	0	0	-	0	0	0	0	0	-	0	0	0	0	0	-	0	0
% Buses	-	0.0	0.0	0.0	-	0.0	-	0.0	0.0	0.0	-	0.0	-	0.0	0.0	0.0	-	0.0	-	0.0	0.0	0.0	-	0.0	0.0
Single-Unit Trucks	0	0	0	1	-	1	0	0	0	0	-	0	0	3	1	0	-	4	0	0	3	0	-	3	8
% Single-Unit Trucks	-	0.0	0.0	0.8	-	0.7	-	0.0	0.0	0.0	-	0.0	-	1.6	1.4	0.0	-	1.4	-	0.0	16.7	0.0	-	13.6	1.7
Articulated Trucks	0	0	0	0	-	0	0	0	0	0	-	0	0	0	5	0	-	5	0	0	3	0	-	3	8
% Articulated Trucks	-	0.0	0.0	0.0	-	0.0	-	0.0	0.0	0.0	-	0.0	-	0.0	7.1	0.0	-	1.8	-	0.0	16.7	0.0	-	13.6	1.7
Bicycles on Road	0	0	0	0	-	0	0	0	0	0	-	0	0	0	0	0	-	0	0	0	0	0	-	0	0
% Bicycles on Road	-	0.0	0.0	0.0	-	0.0	-	0.0	0.0	0.0	-	0.0	-	0.0	0.0	0.0	-	0.0	-	0.0	0.0	0.0	-	0.0	0.0
Pedestrians	-	-	-	-	0	-	-	-	-	-	0	-	-	-	-	-	1	-	-	-	-	-	0	-	-
% Pedestrians	-	-	-	-	-	-	-	-	-	-	-	-	-	-	-	-	100.0	-	-	-	-	-	-	-	-



Kenig Lindgren O'Hara Aboona, Inc.
9575 W. Higgins Rd., Suite 400

Rosemont, Illinois, United States 60018
(847)518-9990 dfreeman@kloainc.com

Count Name: Downers Drive with Access Drive
TMC
Site Code:
Start Date: 08/07/2025
Page No: 4

Turning Movement Peak Hour Data (4:30 PM)

Start Time	Access Drive Eastbound						Access Drive Westbound						Downers Drive Northbound						Downers Drive Southbound						Int. Total
	U-Turn	Left	Thru	Right	Peds	App. Total	U-Turn	Left	Thru	Right	Peds	App. Total	U-Turn	Left	Thru	Right	Peds	App. Total	U-Turn	Left	Thru	Right	Peds	App. Total	
4:30 PM	0	1	14	70	0	85	0	41	10	4	0	55	1	61	9	13	0	84	0	1	26	4	2	31	255
4:45 PM	0	0	11	61	0	72	0	40	12	1	0	53	0	69	2	21	0	92	0	2	18	0	2	20	237
5:00 PM	0	1	13	58	0	72	0	33	15	5	0	53	0	41	6	10	1	57	0	2	22	0	0	24	206
5:15 PM	0	1	17	52	1	70	0	27	8	2	0	37	1	70	7	31	0	109	0	2	17	3	1	22	238
Total	0	3	55	241	1	299	0	141	45	12	0	198	2	241	24	75	1	342	0	7	83	7	5	97	936
Approach %	0.0	1.0	18.4	80.6	-	-	0.0	71.2	22.7	6.1	-	-	0.6	70.5	7.0	21.9	-	-	0.0	7.2	85.6	7.2	-	-	-
Total %	0.0	0.3	5.9	25.7	-	31.9	0.0	15.1	4.8	1.3	-	21.2	0.2	25.7	2.6	8.0	-	36.5	0.0	0.7	8.9	0.7	-	10.4	-
PHF	0.000	0.750	0.809	0.861	-	0.879	0.000	0.860	0.750	0.600	-	0.900	0.500	0.861	0.667	0.605	-	0.784	0.000	0.875	0.798	0.438	-	0.782	0.918
Lights	0	3	55	241	-	299	0	140	45	12	-	197	2	241	22	74	-	339	0	7	78	7	-	92	927
% Lights	-	100.0	100.0	100.0	-	100.0	-	99.3	100.0	100.0	-	99.5	100.0	100.0	91.7	98.7	-	99.1	-	100.0	94.0	100.0	-	94.8	99.0
Buses	0	0	0	0	-	0	0	0	0	0	-	0	0	0	0	0	-	0	0	0	0	0	-	0	0
% Buses	-	0.0	0.0	0.0	-	0.0	-	0.0	0.0	0.0	-	0.0	0.0	0.0	0.0	0.0	-	0.0	-	0.0	0.0	0.0	-	0.0	0.0
Single-Unit Trucks	0	0	0	0	-	0	0	1	0	0	-	1	0	0	2	1	-	3	0	0	3	0	-	3	7
% Single-Unit Trucks	-	0.0	0.0	0.0	-	0.0	-	0.7	0.0	0.0	-	0.5	0.0	0.0	8.3	1.3	-	0.9	-	0.0	3.6	0.0	-	3.1	0.7
Articulated Trucks	0	0	0	0	-	0	0	0	0	0	-	0	0	0	0	0	-	0	0	0	2	0	-	2	2
% Articulated Trucks	-	0.0	0.0	0.0	-	0.0	-	0.0	0.0	0.0	-	0.0	0.0	0.0	0.0	0.0	-	0.0	-	0.0	2.4	0.0	-	2.1	0.2
Bicycles on Road	0	0	0	0	-	0	0	0	0	0	-	0	0	0	0	0	-	0	0	0	0	0	-	0	0
% Bicycles on Road	-	0.0	0.0	0.0	-	0.0	-	0.0	0.0	0.0	-	0.0	0.0	0.0	0.0	0.0	-	0.0	-	0.0	0.0	0.0	-	0.0	0.0
Pedestrians	-	-	-	-	1	-	-	-	-	-	0	-	-	-	-	-	1	-	-	-	-	-	5	-	-
% Pedestrians	-	-	-	-	100.0	-	-	-	-	-	-	-	-	-	-	-	100.0	-	-	-	-	-	100.0	-	-



Kenig Lindgren O'Hara Aboona, Inc.
9575 W. Higgins Rd., Suite 400

Rosemont, Illinois, United States 60018
(847)518-9990 dfreeman@kloainc.com

Count Name: Downers Drive with Access Drive
TMC
Site Code:
Start Date: 08/07/2025
Page No: 5

Turning Movement Peak Hour Data (1:00 PM)

Start Time	Access Drive Eastbound						Access Drive Westbound						Downers Drive Northbound						Downers Drive Southbound						Int. Total
	U-Turn	Left	Thru	Right	Peds	App. Total	U-Turn	Left	Thru	Right	Peds	App. Total	U-Turn	Left	Thru	Right	Peds	App. Total	U-Turn	Left	Thru	Right	Peds	App. Total	
1:00 PM	0	2	30	74	0	106	0	48	19	4	0	71	0	74	2	37	0	113	0	1	1	3	3	5	295
1:15 PM	0	1	18	82	0	101	0	45	20	4	0	69	1	91	3	42	0	137	0	2	3	1	0	6	313
1:30 PM	0	1	32	76	0	109	0	60	17	3	0	80	0	88	3	36	0	127	0	0	4	0	3	4	320
1:45 PM	0	1	16	78	0	95	0	53	17	6	0	76	0	87	0	33	0	120	0	0	2	2	2	4	295
Total	0	5	96	310	0	411	0	206	73	17	0	296	1	340	8	148	0	497	0	3	10	6	8	19	1223
Approach %	0.0	1.2	23.4	75.4	-	-	0.0	69.6	24.7	5.7	-	-	0.2	68.4	1.6	29.8	-	-	0.0	15.8	52.6	31.6	-	-	-
Total %	0.0	0.4	7.8	25.3	-	33.6	0.0	16.8	6.0	1.4	-	24.2	0.1	27.8	0.7	12.1	-	40.6	0.0	0.2	0.8	0.5	-	1.6	-
PHF	0.000	0.625	0.750	0.945	-	0.943	0.000	0.858	0.913	0.708	-	0.925	0.250	0.934	0.667	0.881	-	0.907	0.000	0.375	0.625	0.500	-	0.792	0.955
Lights	0	5	96	310	-	411	0	206	73	17	-	296	1	340	6	148	-	495	0	3	7	6	-	16	1218
% Lights	-	100.0	100.0	100.0	-	100.0	-	100.0	100.0	100.0	-	100.0	100.0	100.0	75.0	100.0	-	99.6	-	100.0	70.0	100.0	-	84.2	99.6
Buses	0	0	0	0	-	0	0	0	0	0	-	0	0	0	0	0	-	0	0	0	0	0	-	0	0
% Buses	-	0.0	0.0	0.0	-	0.0	-	0.0	0.0	0.0	-	0.0	0.0	0.0	0.0	0.0	-	0.0	-	0.0	0.0	0.0	-	0.0	0.0
Single-Unit Trucks	0	0	0	0	-	0	0	0	0	0	-	0	0	0	0	0	-	0	0	0	2	0	-	2	2
% Single-Unit Trucks	-	0.0	0.0	0.0	-	0.0	-	0.0	0.0	0.0	-	0.0	0.0	0.0	0.0	0.0	-	0.0	-	0.0	20.0	0.0	-	10.5	0.2
Articulated Trucks	0	0	0	0	-	0	0	0	0	0	-	0	0	0	2	0	-	2	0	0	1	0	-	1	3
% Articulated Trucks	-	0.0	0.0	0.0	-	0.0	-	0.0	0.0	0.0	-	0.0	0.0	0.0	25.0	0.0	-	0.4	-	0.0	10.0	0.0	-	5.3	0.2
Bicycles on Road	0	0	0	0	-	0	0	0	0	0	-	0	0	0	0	0	-	0	0	0	0	0	-	0	0
% Bicycles on Road	-	0.0	0.0	0.0	-	0.0	-	0.0	0.0	0.0	-	0.0	0.0	0.0	0.0	0.0	-	0.0	-	0.0	0.0	0.0	-	0.0	0.0
Pedestrians	-	-	-	-	0	-	-	-	-	-	0	-	-	-	-	-	0	-	-	-	-	-	8	-	-
% Pedestrians	-	-	-	-	-	-	-	-	-	-	-	-	-	-	-	-	-	-	-	-	-	-	100.0	-	-



Kenig Lindgren O'Hara Aboona, Inc.
9575 W. Higgins Rd., Suite 400

Rosemont, Illinois, United States 60018
(847)518-9990 dfreeman@kloainc.com

Count Name: Internal Access Drive east of
Downers Drive TMC
Site Code:
Start Date: 08/07/2025
Page No: 1

Turning Movement Data

Start Time	Downers Drive Access Drive Eastbound						Great Clips Access Drive Westbound						Parking Lot Access Drive Northbound						Alley Access Drive Southbound						Int. Total
	U-Turn	Left	Thru	Right	Peds	App. Total	U-Turn	Left	Thru	Right	Peds	App. Total	U-Turn	Left	Thru	Right	Peds	App. Total	U-Turn	Left	Thru	Right	Peds	App. Total	
7:00 AM	0	0	7	0	0	7	0	0	7	0	0	7	0	0	0	0	0	0	0	0	0	0	1	0	14
7:15 AM	0	0	2	0	0	2	0	0	5	0	0	5	0	0	0	0	0	0	0	0	0	0	0	0	7
7:30 AM	0	0	9	0	0	9	0	0	5	0	0	5	0	1	0	0	0	0	1	0	0	0	0	0	15
7:45 AM	0	0	6	1	2	7	0	0	7	0	0	7	0	0	0	0	0	0	0	0	0	1	0	1	15
Hourly Total	0	0	24	1	2	25	0	0	24	0	0	24	0	1	0	0	0	1	0	0	0	1	1	1	51
8:00 AM	0	0	3	0	0	3	0	0	6	0	0	6	0	0	0	0	0	0	0	0	0	0	0	0	9
8:15 AM	0	0	8	0	0	8	0	0	6	0	0	6	0	0	0	0	0	0	0	0	0	0	0	0	14
8:30 AM	0	0	11	0	0	11	0	0	8	0	0	8	0	1	0	0	0	1	0	0	0	0	0	0	20
8:45 AM	0	0	10	0	2	10	0	0	11	0	0	11	0	0	0	0	0	0	0	0	0	0	0	0	21
Hourly Total	0	0	32	0	2	32	0	0	31	0	0	31	0	1	0	0	0	1	0	0	0	0	0	0	64
*** BREAK ***	-	-	-	-	-	-	-	-	-	-	-	-	-	-	-	-	-	-	-	-	-	-	-	-	-
4:00 PM	0	0	21	3	15	24	0	1	44	0	10	45	0	0	0	0	0	0	0	0	0	1	3	1	70
4:15 PM	0	0	23	1	7	24	0	1	48	1	5	50	0	1	0	0	0	1	0	0	0	0	6	0	75
4:30 PM	0	0	18	1	9	19	1	2	35	0	11	38	0	1	0	0	0	1	0	0	0	0	6	0	58
4:45 PM	0	0	16	0	11	16	0	3	46	0	12	49	0	1	0	1	0	2	0	0	0	1	5	1	68
Hourly Total	0	0	78	5	42	83	1	7	173	1	38	182	0	3	0	1	0	4	0	0	0	2	20	2	271
5:00 PM	0	2	14	2	9	18	0	3	38	0	18	41	0	0	0	3	0	3	0	0	0	0	5	0	62
5:15 PM	1	1	24	1	10	27	0	2	33	0	18	35	0	1	0	0	1	1	0	0	0	0	7	0	63
5:30 PM	0	0	19	1	15	20	0	1	37	0	15	38	0	2	0	0	0	2	0	0	0	0	0	0	60
5:45 PM	0	0	26	1	9	27	0	3	42	0	13	45	0	0	0	1	0	1	0	0	0	0	3	0	73
Hourly Total	1	3	83	5	43	92	0	9	150	0	64	159	0	3	0	4	1	7	0	0	0	0	15	0	258
*** BREAK ***	-	-	-	-	-	-	-	-	-	-	-	-	-	-	-	-	-	-	-	-	-	-	-	-	-
12:00 PM	1	0	33	3	34	37	0	4	53	2	13	59	0	1	0	3	0	4	0	1	0	0	9	1	101
12:15 PM	0	0	27	0	38	27	0	5	38	0	24	43	0	2	0	4	2	6	0	0	0	0	21	0	76
12:30 PM	0	0	36	3	45	39	0	1	51	1	28	53	0	2	0	1	0	3	0	0	0	1	14	1	96
12:45 PM	1	1	27	3	62	32	0	2	47	1	11	50	0	0	0	3	0	3	0	0	0	0	7	0	85
Hourly Total	2	1	123	9	179	135	0	12	189	4	76	205	0	5	0	11	2	16	0	1	0	1	51	2	358
1:00 PM	0	1	36	4	10	41	0	4	35	1	22	40	0	0	0	3	0	3	0	0	0	0	6	0	84
1:15 PM	0	0	29	3	3	32	0	2	44	0	19	46	0	1	0	0	0	1	0	2	0	0	4	2	81
1:30 PM	0	1	35	4	11	40	0	3	59	0	20	62	0	1	0	1	0	2	0	0	0	0	9	0	104
1:45 PM	0	0	38	1	6	39	0	3	59	0	15	62	0	0	0	1	0	1	0	0	0	0	6	0	102
Hourly Total	0	2	138	12	30	152	0	12	197	1	76	210	0	2	0	5	0	7	0	2	0	0	25	2	371
Grand Total	3	6	478	32	298	519	1	40	764	6	254	811	0	15	0	21	3	36	0	3	0	4	112	7	1373
Approach %	0.6	1.2	92.1	6.2	-	-	0.1	4.9	94.2	0.7	-	-	0.0	41.7	0.0	58.3	-	-	0.0	42.9	0.0	57.1	-	-	-
Total %	0.2	0.4	34.8	2.3	-	37.8	0.1	2.9	55.6	0.4	-	59.1	0.0	1.1	0.0	1.5	-	2.6	0.0	0.2	0.0	0.3	-	0.5	-

Lights	3	6	476	32	-	517	1	40	764	6	-	811	0	15	0	21	-	36	0	3	0	4	-	7	1371
% Lights	100.0	100.0	99.6	100.0	-	99.6	100.0	100.0	100.0	100.0	-	100.0	-	100.0	-	100.0	-	100.0	-	100.0	-	100.0	-	100.0	99.9
Buses	0	0	0	0	-	0	0	0	0	0	-	0	0	0	0	0	-	0	0	0	0	0	-	0	0
% Buses	0.0	0.0	0.0	0.0	-	0.0	0.0	0.0	0.0	0.0	-	0.0	-	0.0	-	0.0	-	0.0	-	0.0	-	0.0	-	0.0	0.0
Single-Unit Trucks	0	0	0	0	-	0	0	0	0	0	-	0	0	0	0	0	-	0	0	0	0	0	-	0	0
% Single-Unit Trucks	0.0	0.0	0.0	0.0	-	0.0	0.0	0.0	0.0	0.0	-	0.0	-	0.0	-	0.0	-	0.0	-	0.0	-	0.0	-	0.0	0.0
Articulated Trucks	0	0	1	0	-	1	0	0	0	0	-	0	0	0	0	0	-	0	0	0	0	0	-	0	1
% Articulated Trucks	0.0	0.0	0.2	0.0	-	0.2	0.0	0.0	0.0	0.0	-	0.0	-	0.0	-	0.0	-	0.0	-	0.0	-	0.0	-	0.0	0.1
Bicycles on Road	0	0	1	0	-	1	0	0	0	0	-	0	0	0	0	0	-	0	0	0	0	0	-	0	1
% Bicycles on Road	0.0	0.0	0.2	0.0	-	0.2	0.0	0.0	0.0	0.0	-	0.0	-	0.0	-	0.0	-	0.0	-	0.0	-	0.0	-	0.0	0.1
Pedestrians	-	-	-	-	-	298	-	-	-	-	-	254	-	-	-	-	-	3	-	-	-	-	-	112	-
% Pedestrians	-	-	-	-	-	100.0	-	-	-	-	-	100.0	-	-	-	-	-	100.0	-	-	-	-	-	100.0	-



Kenig Lindgren O'Hara Aboona, Inc.
9575 W. Higgins Rd., Suite 400

Rosemont, Illinois, United States 60018
(847)518-9990 dfreeman@kloainc.com

Count Name: Internal Access Drive east of
Downers Drive TMC
Site Code:
Start Date: 08/07/2025
Page No: 3

Turning Movement Peak Hour Data (7:45 AM)

Start Time	Downers Drive Access Drive Eastbound						Great Clips Access Drive Westbound						Parking Lot Access Drive Northbound						Alley Access Drive Southbound						Int. Total
	U-Turn	Left	Thru	Right	Peds	App. Total	U-Turn	Left	Thru	Right	Peds	App. Total	U-Turn	Left	Thru	Right	Peds	App. Total	U-Turn	Left	Thru	Right	Peds	App. Total	
7:45 AM	0	0	6	1	2	7	0	0	7	0	0	7	0	0	0	0	0	0	0	0	0	1	0	1	15
8:00 AM	0	0	3	0	0	3	0	0	6	0	0	6	0	0	0	0	0	0	0	0	0	0	0	0	9
8:15 AM	0	0	8	0	0	8	0	0	6	0	0	6	0	0	0	0	0	0	0	0	0	0	0	0	14
8:30 AM	0	0	11	0	0	11	0	0	8	0	0	8	0	1	0	0	0	1	0	0	0	0	0	0	20
Total	0	0	28	1	2	29	0	0	27	0	0	27	0	1	0	0	0	1	0	0	0	1	0	1	58
Approach %	0.0	0.0	96.6	3.4	-	-	0.0	0.0	100.0	0.0	-	-	0.0	100.0	0.0	0.0	-	-	0.0	0.0	0.0	100.0	-	-	-
Total %	0.0	0.0	48.3	1.7	-	50.0	0.0	0.0	46.6	0.0	-	46.6	0.0	1.7	0.0	0.0	-	1.7	0.0	0.0	0.0	1.7	-	1.7	-
PHF	0.000	0.000	0.636	0.250	-	0.659	0.000	0.000	0.844	0.000	-	0.844	0.000	0.250	0.000	0.000	-	0.250	0.000	0.000	0.000	0.250	-	0.250	0.725
Lights	0	0	28	1	-	29	0	0	27	0	-	27	0	1	0	0	-	1	0	0	0	1	-	1	58
% Lights	-	-	100.0	100.0	-	100.0	-	-	100.0	-	-	100.0	-	100.0	-	-	-	100.0	-	-	-	100.0	-	100.0	100.0
Buses	0	0	0	0	-	0	0	0	0	0	-	0	0	0	0	0	-	0	0	0	0	0	-	0	0
% Buses	-	-	0.0	0.0	-	0.0	-	-	0.0	-	-	0.0	-	0.0	-	-	-	0.0	-	-	-	0.0	-	0.0	0.0
Single-Unit Trucks	0	0	0	0	-	0	0	0	0	0	-	0	0	0	0	0	-	0	0	0	0	0	-	0	0
% Single-Unit Trucks	-	-	0.0	0.0	-	0.0	-	-	0.0	-	-	0.0	-	0.0	-	-	-	0.0	-	-	-	0.0	-	0.0	0.0
Articulated Trucks	0	0	0	0	-	0	0	0	0	0	-	0	0	0	0	0	-	0	0	0	0	0	-	0	0
% Articulated Trucks	-	-	0.0	0.0	-	0.0	-	-	0.0	-	-	0.0	-	0.0	-	-	-	0.0	-	-	-	0.0	-	0.0	0.0
Bicycles on Road	0	0	0	0	-	0	0	0	0	0	-	0	0	0	0	0	-	0	0	0	0	0	-	0	0
% Bicycles on Road	-	-	0.0	0.0	-	0.0	-	-	0.0	-	-	0.0	-	0.0	-	-	-	0.0	-	-	-	0.0	-	0.0	0.0
Pedestrians	-	-	-	-	2	-	-	-	-	-	0	-	-	-	-	-	0	-	-	-	-	-	0	-	-
% Pedestrians	-	-	-	-	100.0	-	-	-	-	-	-	-	-	-	-	-	-	-	-	-	-	-	-	-	-



Kenig Lindgren O'Hara Aboona, Inc.
9575 W. Higgins Rd., Suite 400

Rosemont, Illinois, United States 60018
(847)518-9990 dfreeman@kloainc.com

Count Name: Internal Access Drive east of
Downers Drive TMC
Site Code:
Start Date: 08/07/2025
Page No: 4

Turning Movement Peak Hour Data (4:30 PM)

Start Time	Downers Drive Access Drive Eastbound						Great Clips Access Drive Westbound						Parking Lot Access Drive Northbound						Alley Access Drive Southbound						Int. Total
	U-Turn	Left	Thru	Right	Peds	App. Total	U-Turn	Left	Thru	Right	Peds	App. Total	U-Turn	Left	Thru	Right	Peds	App. Total	U-Turn	Left	Thru	Right	Peds	App. Total	
4:30 PM	0	0	18	1	9	19	1	2	35	0	11	38	0	1	0	0	0	1	0	0	0	0	6	0	58
4:45 PM	0	0	16	0	11	16	0	3	46	0	12	49	0	1	0	1	0	2	0	0	0	1	5	1	68
5:00 PM	0	2	14	2	9	18	0	3	38	0	18	41	0	0	0	3	0	3	0	0	0	0	5	0	62
5:15 PM	1	1	24	1	10	27	0	2	33	0	18	35	0	1	0	0	1	1	0	0	0	0	7	0	63
Total	1	3	72	4	39	80	1	10	152	0	59	163	0	3	0	4	1	7	0	0	0	1	23	1	251
Approach %	1.3	3.8	90.0	5.0	-	-	0.6	6.1	93.3	0.0	-	-	0.0	42.9	0.0	57.1	-	-	0.0	0.0	0.0	100.0	-	-	-
Total %	0.4	1.2	28.7	1.6	-	31.9	0.4	4.0	60.6	0.0	-	64.9	0.0	1.2	0.0	1.6	-	2.8	0.0	0.0	0.0	0.4	-	0.4	-
PHF	0.250	0.375	0.750	0.500	-	0.741	0.250	0.833	0.826	0.000	-	0.832	0.000	0.750	0.000	0.333	-	0.583	0.000	0.000	0.000	0.250	-	0.250	0.923
Lights	1	3	71	4	-	79	1	10	152	0	-	163	0	3	0	4	-	7	0	0	0	1	-	1	250
% Lights	100.0	100.0	98.6	100.0	-	98.8	100.0	100.0	100.0	-	-	100.0	-	100.0	-	100.0	-	100.0	-	-	-	100.0	-	100.0	99.6
Buses	0	0	0	0	-	0	0	0	0	0	-	0	0	0	0	0	-	0	0	0	0	0	-	0	0
% Buses	0.0	0.0	0.0	0.0	-	0.0	0.0	0.0	0.0	-	-	0.0	-	0.0	-	0.0	-	0.0	-	-	-	0.0	-	0.0	0.0
Single-Unit Trucks	0	0	0	0	-	0	0	0	0	0	-	0	0	0	0	0	-	0	0	0	0	0	-	0	0
% Single-Unit Trucks	0.0	0.0	0.0	0.0	-	0.0	0.0	0.0	0.0	-	-	0.0	-	0.0	-	0.0	-	0.0	-	-	-	0.0	-	0.0	0.0
Articulated Trucks	0	0	0	0	-	0	0	0	0	0	-	0	0	0	0	0	-	0	0	0	0	0	-	0	0
% Articulated Trucks	0.0	0.0	0.0	0.0	-	0.0	0.0	0.0	0.0	-	-	0.0	-	0.0	-	0.0	-	0.0	-	-	-	0.0	-	0.0	0.0
Bicycles on Road	0	0	1	0	-	1	0	0	0	0	-	0	0	0	0	0	-	0	0	0	0	0	-	0	1
% Bicycles on Road	0.0	0.0	1.4	0.0	-	1.3	0.0	0.0	0.0	-	-	0.0	-	0.0	-	0.0	-	0.0	-	-	-	0.0	-	0.0	0.4
Pedestrians	-	-	-	-	39	-	-	-	-	-	59	-	-	-	-	-	1	-	-	-	-	-	23	-	-
% Pedestrians	-	-	-	-	100.0	-	-	-	-	-	100.0	-	-	-	-	-	100.0	-	-	-	-	-	100.0	-	-



Kenig Lindgren O'Hara Aboona, Inc.
9575 W. Higgins Rd., Suite 400

Rosemont, Illinois, United States 60018
(847)518-9990 dfreeman@kloainc.com

Count Name: Internal Access Drive east of
Downers Drive TMC
Site Code:
Start Date: 08/07/2025
Page No: 5

Turning Movement Peak Hour Data (1:00 PM)

Start Time	Downers Drive Access Drive Eastbound						Great Clips Access Drive Westbound						Parking Lot Access Drive Northbound						Alley Access Drive Southbound						Int. Total
	U-Turn	Left	Thru	Right	Peds	App. Total	U-Turn	Left	Thru	Right	Peds	App. Total	U-Turn	Left	Thru	Right	Peds	App. Total	U-Turn	Left	Thru	Right	Peds	App. Total	
1:00 PM	0	1	36	4	10	41	0	4	35	1	22	40	0	0	0	3	0	3	0	0	0	0	6	0	84
1:15 PM	0	0	29	3	3	32	0	2	44	0	19	46	0	1	0	0	0	1	0	2	0	0	4	2	81
1:30 PM	0	1	35	4	11	40	0	3	59	0	20	62	0	1	0	1	0	2	0	0	0	0	9	0	104
1:45 PM	0	0	38	1	6	39	0	3	59	0	15	62	0	0	0	1	0	1	0	0	0	0	6	0	102
Total	0	2	138	12	30	152	0	12	197	1	76	210	0	2	0	5	0	7	0	2	0	0	25	2	371
Approach %	0.0	1.3	90.8	7.9	-	-	0.0	5.7	93.8	0.5	-	-	0.0	28.6	0.0	71.4	-	-	0.0	100.0	0.0	0.0	-	-	-
Total %	0.0	0.5	37.2	3.2	-	41.0	0.0	3.2	53.1	0.3	-	56.6	0.0	0.5	0.0	1.3	-	1.9	0.0	0.5	0.0	0.0	-	0.5	-
PHF	0.000	0.500	0.908	0.750	-	0.927	0.000	0.750	0.835	0.250	-	0.847	0.000	0.500	0.000	0.417	-	0.583	0.000	0.250	0.000	0.000	-	0.250	0.892
Lights	0	2	138	12	-	152	0	12	197	1	-	210	0	2	0	5	-	7	0	2	0	0	-	2	371
% Lights	-	100.0	100.0	100.0	-	100.0	-	100.0	100.0	100.0	-	100.0	-	100.0	-	100.0	-	100.0	-	100.0	-	-	-	100.0	100.0
Buses	0	0	0	0	-	0	0	0	0	0	-	0	0	0	0	0	-	0	0	0	0	0	-	0	0
% Buses	-	0.0	0.0	0.0	-	0.0	-	0.0	0.0	0.0	-	0.0	-	0.0	-	0.0	-	0.0	-	0.0	-	-	-	0.0	0.0
Single-Unit Trucks	0	0	0	0	-	0	0	0	0	0	-	0	0	0	0	0	-	0	0	0	0	0	-	0	0
% Single-Unit Trucks	-	0.0	0.0	0.0	-	0.0	-	0.0	0.0	0.0	-	0.0	-	0.0	-	0.0	-	0.0	-	0.0	-	-	-	0.0	0.0
Articulated Trucks	0	0	0	0	-	0	0	0	0	0	-	0	0	0	0	0	-	0	0	0	0	0	-	0	0
% Articulated Trucks	-	0.0	0.0	0.0	-	0.0	-	0.0	0.0	0.0	-	0.0	-	0.0	-	0.0	-	0.0	-	0.0	-	-	-	0.0	0.0
Bicycles on Road	0	0	0	0	-	0	0	0	0	0	-	0	0	0	0	0	-	0	0	0	0	0	-	0	0
% Bicycles on Road	-	0.0	0.0	0.0	-	0.0	-	0.0	0.0	0.0	-	0.0	-	0.0	-	0.0	-	0.0	-	0.0	-	-	-	0.0	0.0
Pedestrians	-	-	-	-	30	-	-	-	-	-	76	-	-	-	-	-	0	-	-	-	-	-	25	-	-
% Pedestrians	-	-	-	-	100.0	-	-	-	-	-	100.0	-	-	-	-	-	-	-	-	-	-	-	100.0	-	-



Kenig Lindgren O'Hara Aboona, Inc.
9575 W. Higgins Rd., Suite 400

Rosemont, Illinois, United States 60018
(847)518-9990 dfreeman@kloainc.com

Count Name: I Access Drive north of Butterfield
Road TMC
Site Code:
Start Date: 08/07/2025
Page No: 1

Turning Movement Data

Start Time	butterfield rd Eastbound					butterfield rd Westbound					access Southbound					Int. Total
	U-Turn	Left	Thru	Peds	App. Total	U-Turn	Thru	Right	Peds	App. Total	U-Turn	Left	Right	Peds	App. Total	
7:00 AM	0	0	309	0	309	0	272	4	0	276	0	0	2	0	2	587
7:15 AM	0	0	356	0	356	0	391	5	0	396	0	0	2	0	2	754
7:30 AM	0	0	392	0	392	0	395	5	0	400	0	0	2	0	2	794
7:45 AM	0	0	440	0	440	0	523	5	0	528	0	0	2	0	2	970
Hourly Total	0	0	1497	0	1497	0	1581	19	0	1600	0	0	8	0	8	3105
8:00 AM	0	0	474	0	474	0	450	7	0	457	0	0	2	0	2	933
8:15 AM	0	0	458	0	458	0	424	4	0	428	0	0	2	0	2	888
8:30 AM	0	0	422	0	422	0	449	5	0	454	0	0	1	0	1	877
8:45 AM	0	0	433	0	433	0	416	8	0	424	0	0	4	0	4	861
Hourly Total	0	0	1787	0	1787	0	1739	24	0	1763	0	0	9	0	9	3559
*** BREAK ***	-	-	-	-	-	-	-	-	-	-	-	-	-	-	-	-
4:00 PM	0	0	453	0	453	0	683	26	0	709	0	0	12	0	12	1174
4:15 PM	0	0	497	0	497	0	607	27	0	634	0	0	11	1	11	1142
4:30 PM	0	0	448	0	448	0	650	21	0	671	0	0	8	0	8	1127
4:45 PM	0	0	506	0	506	0	655	32	0	687	0	0	10	0	10	1203
Hourly Total	0	0	1904	0	1904	0	2595	106	0	2701	0	0	41	1	41	4646
5:00 PM	0	0	496	0	496	0	762	25	0	787	0	0	10	0	10	1293
5:15 PM	0	0	476	0	476	0	765	27	0	792	0	0	7	0	7	1275
5:30 PM	0	0	488	0	488	0	601	24	0	625	0	0	9	0	9	1122
5:45 PM	0	0	509	0	509	0	603	24	0	627	0	0	12	0	12	1148
Hourly Total	0	0	1969	0	1969	0	2731	100	0	2831	0	0	38	0	38	4838
*** BREAK ***	-	-	-	-	-	-	-	-	-	-	-	-	-	-	-	-
12:00 PM	0	0	378	0	378	0	477	35	0	512	0	0	16	0	16	906
12:15 PM	0	0	335	0	335	0	503	25	0	528	0	0	10	0	10	873
12:30 PM	0	0	342	0	342	0	478	37	0	515	0	0	10	0	10	867
12:45 PM	0	0	334	0	334	0	496	36	0	532	0	0	21	0	21	887
Hourly Total	0	0	1389	0	1389	0	1954	133	0	2087	0	0	57	0	57	3533
1:00 PM	0	0	355	0	355	0	540	28	0	568	0	0	9	0	9	932
1:15 PM	0	0	348	0	348	0	524	25	0	549	0	0	14	0	14	911
1:30 PM	0	0	355	0	355	0	513	36	0	549	0	0	18	0	18	922
1:45 PM	0	0	362	0	362	0	513	36	0	549	0	0	10	0	10	921
Hourly Total	0	0	1420	0	1420	0	2090	125	0	2215	0	0	51	0	51	3686
Grand Total	0	0	9966	0	9966	0	12690	507	0	13197	0	0	204	1	204	23367
Approach %	0.0	0.0	100.0	-	-	0.0	96.2	3.8	-	-	0.0	0.0	100.0	-	-	-
Total %	0.0	0.0	42.6	-	42.6	0.0	54.3	2.2	-	56.5	0.0	0.0	0.9	-	0.9	-
Lights	0	0	9805	-	9805	0	12499	504	-	13003	0	0	201	-	201	23009

% Lights	-	-	98.4	-	98.4	-	98.5	99.4	-	98.5	-	-	98.5	-	98.5	98.5
Buses	0	0	25	-	25	0	34	0	-	34	0	0	0	-	0	59
% Buses	-	-	0.3	-	0.3	-	0.3	0.0	-	0.3	-	-	0.0	-	0.0	0.3
Single-Unit Trucks	0	0	100	-	100	0	117	2	-	119	0	0	2	-	2	221
% Single-Unit Trucks	-	-	1.0	-	1.0	-	0.9	0.4	-	0.9	-	-	1.0	-	1.0	0.9
Articulated Trucks	0	0	36	-	36	0	40	1	-	41	0	0	1	-	1	78
% Articulated Trucks	-	-	0.4	-	0.4	-	0.3	0.2	-	0.3	-	-	0.5	-	0.5	0.3
Bicycles on Road	0	0	0	-	0	0	0	0	-	0	0	0	0	-	0	0
% Bicycles on Road	-	-	0.0	-	0.0	-	0.0	0.0	-	0.0	-	-	0.0	-	0.0	0.0
Pedestrians	-	-	-	0	-	-	-	-	0	-	-	-	-	1	-	-
% Pedestrians	-	-	-	-	-	-	-	-	-	-	-	-	-	100.0	-	-

Site Plan

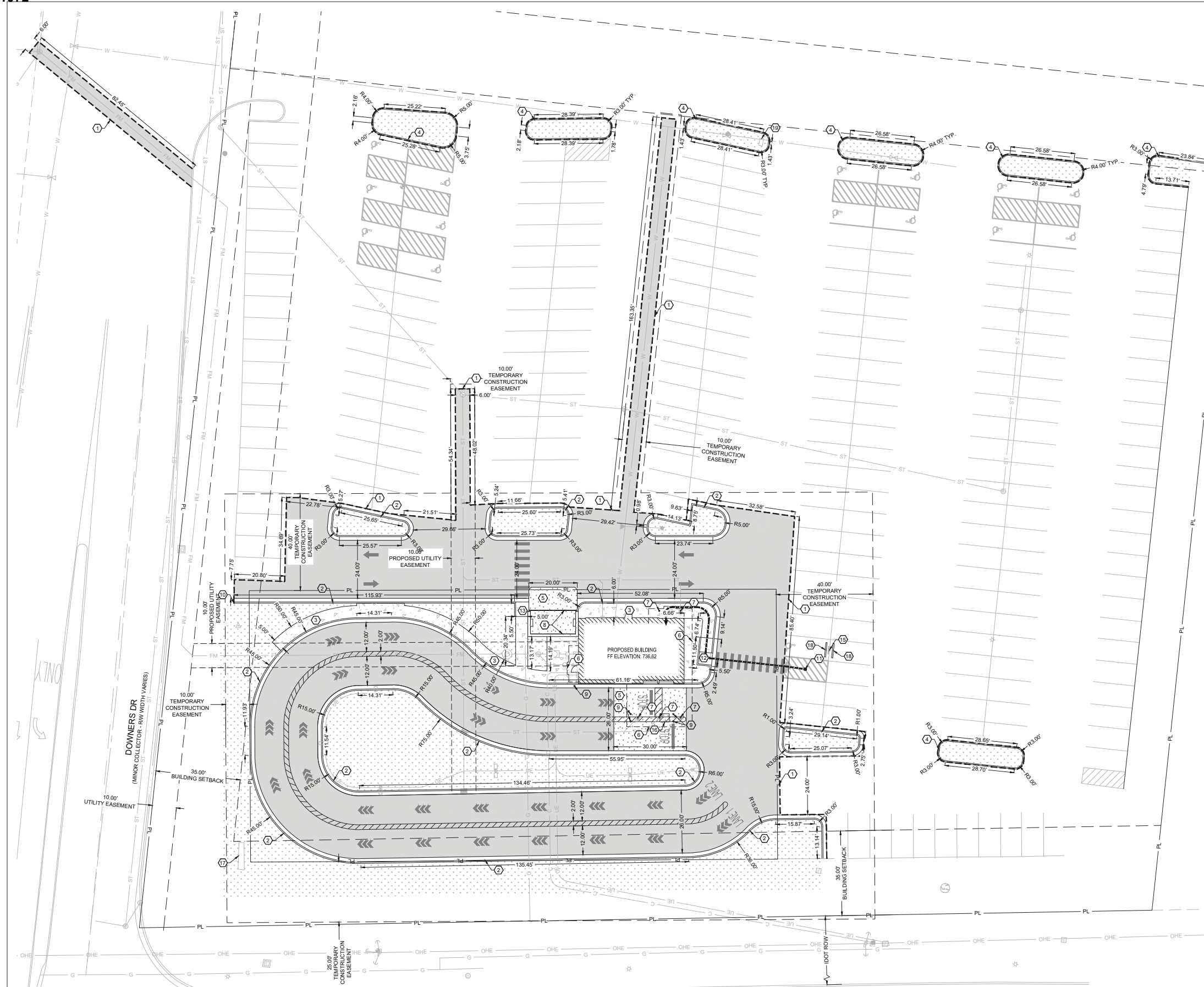

- HATCH LEGEND:**
- ASPHALT PAVEMENT PER DETAIL 2.06, SHEET C7.1.
 - CONCRETE SIDEWALK PER SIDEWALK DETAIL 2.02, SHEET C7.1.
 - CONCRETE PAVEMENT PER CONCRETE PAVEMENT DETAIL 2.03 AND 2.05, SHEET C7.1.
 - LANDSCAPE AREA REFER TO LANDSCAPE PLAN.

- KEY NOTES:**
- ① MATCH EXISTING PAVEMENT.
 - ② CONCRETE CURB & GUTTER PER CITY DETAIL, SHEET C7.4.
 - ③ SIDEWALK PER DETAIL 2.02, SHEET C7.1.
 - ④ 6" CONCRETE CURB WITH NO GUTTER.
 - ⑤ CONCRETE PAVEMENT PER CONCRETE PAVEMENT DETAILS 2.03 & 2.05, SHEET C7.1.
 - ⑥ BUILDING CANOPY OUTLINE.
 - ⑦ CANOPY COLUMNS LOCATIONS, TYPICAL.
 - ⑧ TRASH ENCLOSURE AND GATE, PER ARCHITECTURAL PLANS.
 - ⑨ 3" PIPE BOLLARD, TYPICAL PER DETAIL 2.09, SHEET C7.1.
 - ⑩ CURB TRANSITION PER DETAIL 2.15, SHEET C7.1.
 - ⑪ ACCESSIBLE PATH FROM PARKING TO BUILDING.
 - ⑫ MODIFIED TYPE 2 ADA CURB RAMP PER CITY DETAIL, SHEET C7.4.
 - ⑬ TYPE 4 ADA CURB RAMP PER CITY DETAIL, SHEET C7.4.
 - ⑭ SIGN, SEE SHEET C6.1.
 - ⑮ CANVAS CRAFT WARMING HUT, PER ARCHITECTURAL PLANS.
 - ⑯ EXISTING MONUMENT SIGN.
 - ⑰ CONCRETE WHEEL STOP.
 - ⑱ DIRECTIONAL SIGN.

PROPOSED USE:
RESTAURANT WITH DRIVE THRU.

ZONING:
ZONING DISTRICT: B3, GENERAL SERVICE & HIGHWAY BUSINESS

PARKING REQUIREMENTS: 7 BREW
REQUIRED: 1 SPACE PER EMPLOYEES DURING LARGEST SHIFT = 6 STALLS.
PROVIDED: 7 STALLS, 6 STANDARD AND 1 ADA.

PARKING REQUIREMENTS: PUD DEVELOPMENT
REQUIRED: 106,221 S.F. @ 3.5 PARKING SPACE / 1000 S.F. OF BUILDING AREA = 382
PROVIDED POST 7 BREW DEVELOPEMENT: 320 STALLS.

DRIVE-TRHU QUEUE STACKING REQUIREMENTS:
REQUIRED: 8 SPACES.
PROVIDED: 39 SPACES.

STORMWATER NOTES:

PRE-PROJECT IMPERVIOUS AREA	= ±	33,775 S.F.
PRE-PROJECT PERVIOUS AREA	= ±	5,613 S.F.
TOTAL	= ±	39,388 S.F.
POST-PROJECT IMPERVIOUS AREA	= ±	26,984 S.F.
POST-PROJECT PERVIOUS AREA	= ±	12,404 S.F.
TOTAL	= ±	39,388 S.F.

NOTES:
IMPERVIOUS AND PERVIOUS SURFACE CALCULATIONS ARE BOUNDED BY SAWCUT LINES TO THE NORTH AND EAST, AND LIMIT OF DISTURBANCE TO THE SOUTH AND WEST.

BUILDING AND LOT DATA:

PROJECT FOOTPRINT	33,252 S.F.	=	0.76 ACRES
PROPOSED BUILDING (1 STORY) - RETAIL		=	1,172 S.F.
CONSTRUCTION TYPE: V-B			

QUANTITIES:

CURB & GUTTER	= ±	1,380 L.F.
ASPHALT PAVEMENT	= ±	20,772 S.F.
8-INCH CONCRETE PAVEMENT	= ±	1,179 S.F.
4-INCH CONCRETE SIDEWALK	= ±	1,652 S.F.
LANDSCAPING	= ±	13,171 S.F.

NOTES:
ANY CHANGES MADE TO THE SITE PLAN OR IN THE FIELD DURING CONSTRUCTION MUST BE SUBMITTED IN WRITING TO THE VILLAGE OF DOWNER'S GROVE.



0 10 20
H. SCALE: 1" = 20'



ENGINEER OF RECORD:
NAME: MATTHEW STEVEN MILLER
LICENSE NO. IL #062 065164
EXP. 11/30/2027

PROJECT NUMBER:
104 068

REVISION:

7 BREW COFFEE
DOWNERS GROVE, IL 02
1434 BUTTERFIELD RD
DOWNERS GROVE, IL 60515

C2.1
SITE PLAN

DATE: DECEMBER 9TH, 2025

ITE Trip Generation Sheets

Coffee/Donut Shop with Drive-Through Window and No Indoor Seating (938)

Vehicle Trip Ends vs: Drive-Through Lanes

**On a: Weekday,
Peak Hour of Adjacent Street Traffic,
One Hour Between 7 and 9 a.m.**

Setting/Location: General Urban/Suburban

Number of Studies: 20

Avg. Num. of Drive-Through Lanes: 1

Directional Distribution: 50% entering, 50% exiting

Vehicle Trip Generation per Drive-Through Lane

Average Rate	Range of Rates	Standard Deviation
39.81	16.00 - 69.00	15.44

Data Plot and Equation

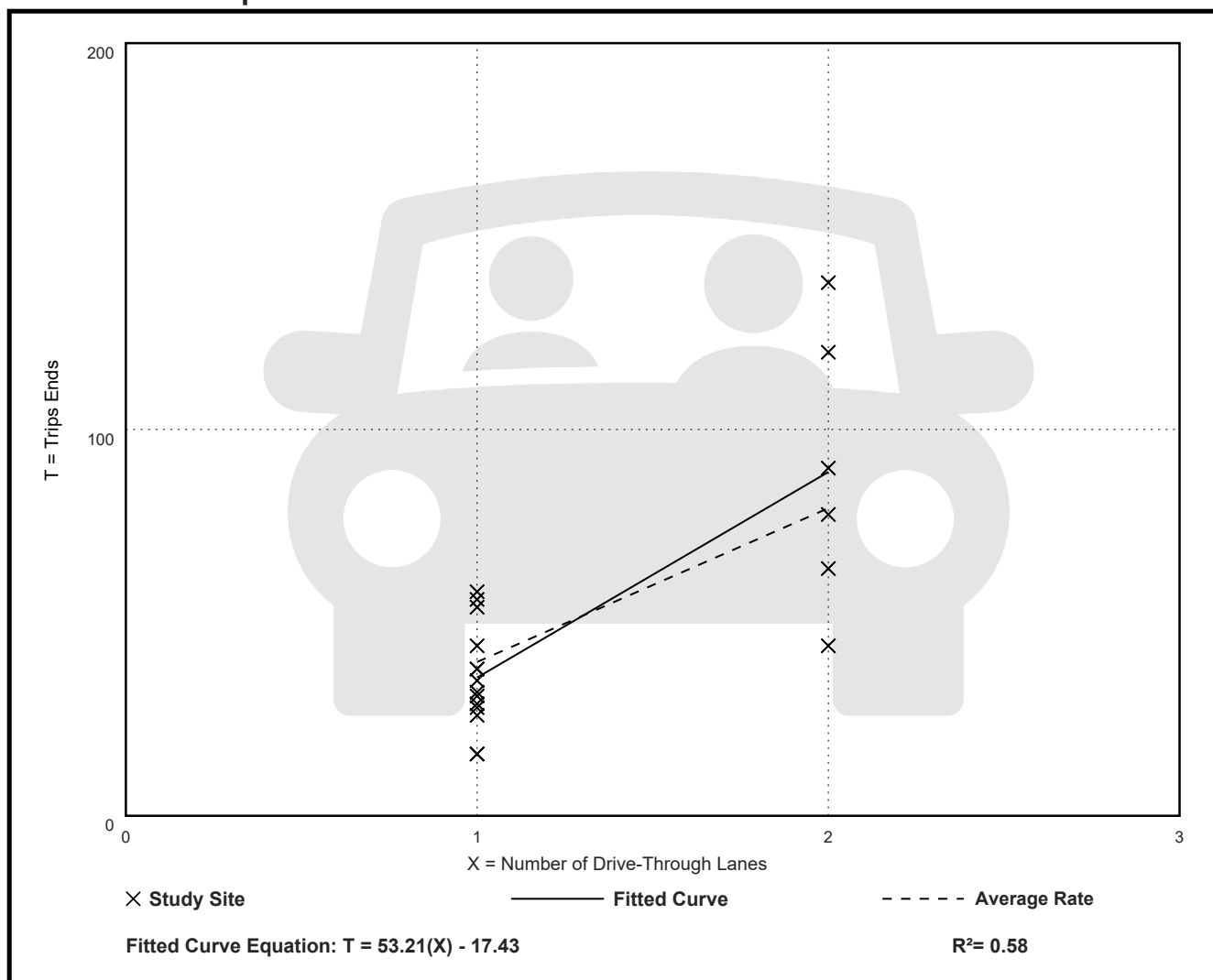

Coffee/Donut Shop with Drive-Through Window and No Indoor Seating (938)

Vehicle Trip Ends vs: Drive-Through Lanes

**On a: Weekday,
Peak Hour of Adjacent Street Traffic,
One Hour Between 4 and 6 p.m.**

Setting/Location: General Urban/Suburban

Number of Studies: 8

Avg. Num. of Drive-Through Lanes: 2

Directional Distribution: 50% entering, 50% exiting

Vehicle Trip Generation per Drive-Through Lane

Average Rate	Range of Rates	Standard Deviation
15.08	2.50 - 55.00	19.41

Data Plot and Equation

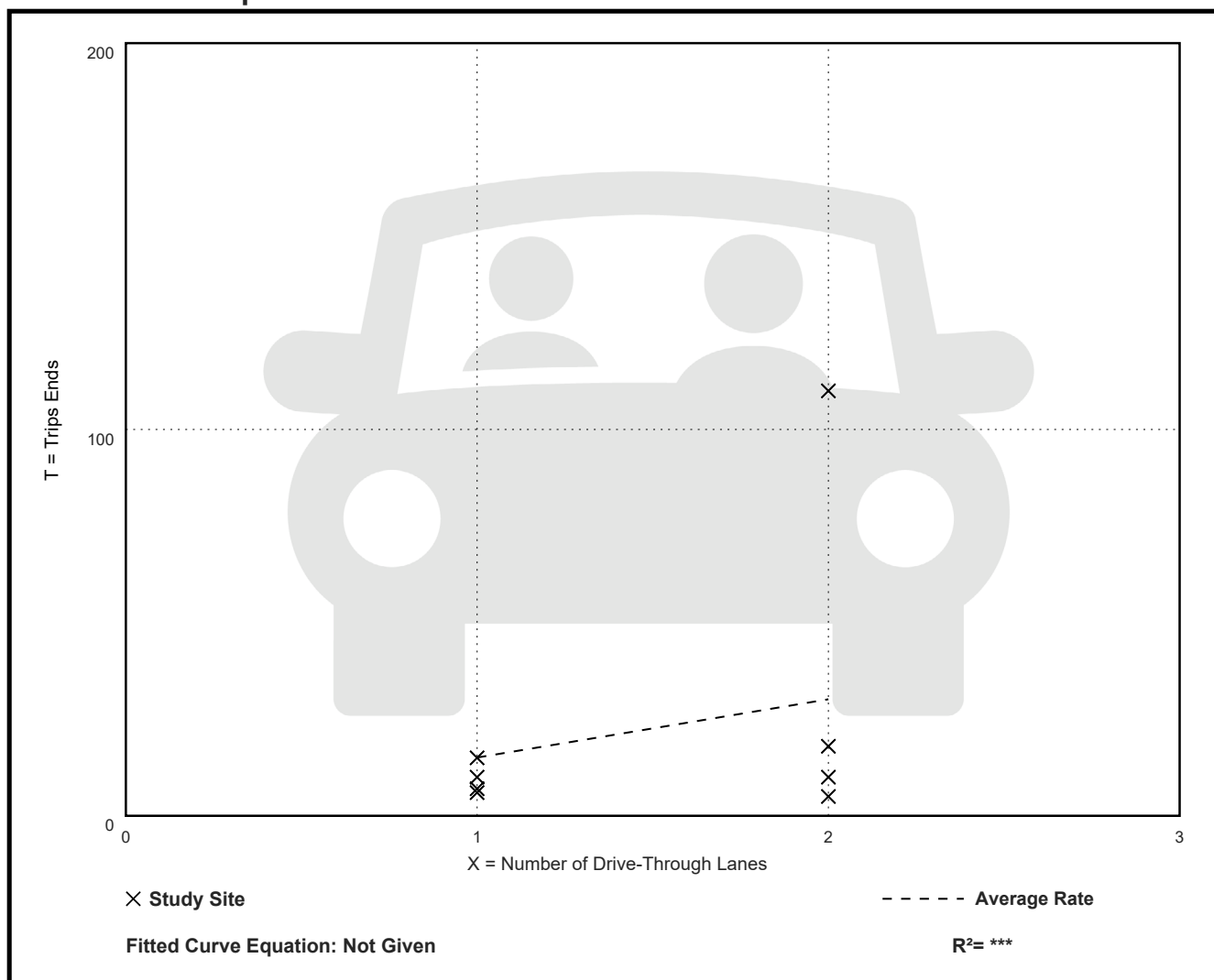

CMAP 2050 Projections Letter



433 West Van Buren Street, Suite 450
Chicago, IL 60607
cmap.illinois.gov | 312-454-0400

July 24, 2025

Ryan May
Project Coordinator
Kenig, Lindgren, O'Hara and Aboona, Inc.
9575 West Higgins Road
Suite 400
Rosemont, IL 60018

Subject: Downers Drive with Butterfield Road
IDOT

Dear Mr. May:

In response to a request made on your behalf and dated July 23, 2025, we have developed year 2050 average daily traffic (ADT) projections for the subject location.

ROAD SEGMENT	Current ADT	Year 2050 ADT
Downers Drive at Butterfield Road	1,450	1,550
Butterfield Road at Downers Drive	40,800	43,600

Traffic projections are developed using existing ADT data provided in the request letter and the results from the June 2025 CMAP Travel Demand Analysis. The regional travel model uses CMAP 2050 socioeconomic projections and assumes the implementation of the ON TO 2050 Comprehensive Regional Plan for the Northeastern Illinois area. The provision of this data in support of your request does not constitute a CMAP endorsement of the proposed development or any subsequent developments.

If you have any questions, please call me at (312) 386-8806 or email me at jrodriguez@cmap.illinois.gov

Jose Rodriguez, PTP, AICP
Senior Planner, Research & Analysis

cc: Rios (IDOT)
S:\AdminGroups\ResearchAnalysis\2025_trafficForecasts\DownersGrove\du-42-25\du-42-25.docx

TRAFFIC FORECAST RECORD

Record Number: du-42-25

Type of Report: Projection

Year Sought: 2050

Analyst: JAR

Organization Requestion Forecast: KLOA

Contact: Ryan May

Email or Phone: rmay@kloainc.com

Sponsor: IDOT

Date request was received: 7/23/2025

Date that response was emailed: 7/24/2025

Facility Location: Downers Drive with Butterfield Road

Municipality: Downers Grove

Level of Service Criteria

LEVEL OF SERVICE CRITERIA

Signalized Intersections		
Level of Service	Interpretation	Average Control Delay (seconds per vehicle)
A	Favorable progression. Most vehicles arrive during the green indication and travel through the intersection without stopping.	≤10
B	Good progression, with more vehicles stopping than for Level of Service A.	> 10 - 20
C	Individual cycle failures (i.e., one or more queued vehicles are not able to depart as a result of insufficient capacity during the cycle) may begin to appear. Number of vehicles stopping is significant, although many vehicles still pass through the intersection without stopping.	> 20 - 35
D	The volume-to-capacity ratio is high and either progression is ineffective or the cycle length is too long. Many vehicles stop and individual cycle failures are noticeable.	> 35 - 55
E	Progression is unfavorable. The volume-to-capacity ratio is high and the cycle length is long. Individual cycle failures are frequent.	> 55 - 80
F	The volume-to-capacity ratio is very high, progression is very poor, and the cycle length is long. Most cycles fail to clear the queue.	> 80
Unsignalized Intersections		
Level of Service	Average Total Delay (sec/veh)	
A	0 - 10	
B	> 10 - 15	
C	> 15 - 25	
D	> 25 - 35	
E	> 35 - 50	
F	> 50	
Source: <i>Highway Capacity Manual</i> , 7 th Edition.		

Capacity Analysis Summary Sheets
Existing Weekday Morning Peak Hour

Intersection Capacity Utilization 12: Access Drive & Access Road

11/19/2025



Movement	EBL	EBT	EBR	WBL	WBT	WBR	NBL	NBT	NBR	SBL	SBT	SBR	
Lane Configurations		↕			↕			↕			↕		
Volume (vph)	0	28	1	0	27	0	1	0	0	0	0	1	
Pedestrians													
Ped Button													
Pedestrian Timing (s)													
Free Right	No			No			No			No			
Ideal Flow	1900	1900	1900	1900	1900	1900	1900	1900	1900	1900	1900	1900	
Lost Time (s)	4.0	4.0	4.0	4.0	4.0	4.0	4.0	4.0	4.0	4.0	4.0	4.0	
Minimum Green (s)	4.0	4.0	4.0	4.0	4.0	4.0	4.0	4.0	4.0	4.0	4.0	4.0	
Refr Cycle Length (s)	120	120	120	120	120	120	120	120	120	120	120	120	
Volume Combined (vph)	0	29	0	0	27	0	0	1	0	0	1	0	
Lane Utilization Factor	1.00	1.00	1.00	1.00	1.00	1.00	1.00	1.00	1.00	1.00	1.00	1.00	
Turning Factor (vph)	0.95	0.99	0.85	0.95	1.00	0.85	0.95	0.95	0.85	0.95	0.85	0.85	
Saturated Flow (vph)	0	1890	0	0	1900	0	0	1805	0	0	1615	0	
Ped Intf Time (s)	0.0	0.0	0.0	0.0	0.0	0.0	0.0	0.0	0.0	0.0	0.0	0.0	
Pedestrian Frequency (%)	0.00		0.00				0.00		0.00				
Protected Option Allowed	No			No			No			No			
Reference Time (s)	0.0			0.0			0.0			0.0			
Adj Reference Time (s)	0.0			0.0			0.0			0.0			
Permitted Option													
Adj Saturation A (vph)	0	1890	0	1900	0	120	0	1615					
Reference Time A (s)	0.0	1.8	0.0	1.7	0.0	1.0	0.0	0.1					
Adj Saturation B (vph)	0	1890	0	1900	0	0	0	1615					
Reference Time B (s)	0.0	1.8	0.0	1.7	8.1	8.1	0.0	0.1					
Reference Time (s)	1.8		1.7		1.0		0.1						
Adj Reference Time (s)	8.0		8.0		8.0		8.0						
Split Option													
Ref Time Combined (s)	0.0	1.8	0.0	1.7	0.0	0.1	0.0	0.1	0.0	0.1			
Ref Time Seperate (s)	0.0	1.8	0.0	1.7	0.1	0.0	0.0	0.0	0.0	0.0			
Reference Time (s)	1.8	1.8	1.7	1.7	0.1	0.1	0.1	0.1	0.1	0.1			
Adj Reference Time (s)	8.0	8.0	8.0	8.0	8.0	8.0	8.0	8.0	8.0	8.0			
Summary	EB WB		NB SB		Combined								
Protected Option (s)	NA		NA										
Permitted Option (s)	8.0		8.0										
Split Option (s)	16.0		16.0										
Minimum (s)	8.0		8.0		16.0								
Right Turns													
Adj Reference Time (s)													
Cross Thru Ref Time (s)													
Oncoming Left Ref Time (s)													
Combined (s)													
Intersection Summary													
Intersection Capacity Utilization	13.3%				ICU Level of Service				A				
Reference Times and Phasing Options do not represent an optimized timing plan.													

Lanes and Geometrics

3: Downers Drive & Butterfield Road

11/20/2025

Lane Group	EBL	EBT	EBR	WBL	WBT	WBR	NBL	NBT	NBR	SBL	SBT	SBR
Lane Configurations												
Traffic Volume (vph)	71	1672	158	372	1283	198	19	13	34	88	34	36
Future Volume (vph)	71	1672	158	372	1283	198	19	13	34	88	34	36
Ideal Flow (vphpl)	1900	2000	1900	1900	2000	1900	1900	1900	1900	1900	1900	1900
Storage Length (ft)	230		280	350		335	0		0	0		150
Storage Lanes	2		1	2		1	1		0	1		1
Taper Length (ft)	300			300			25			0		
Lane Util. Factor	0.97	0.91	1.00	0.97	0.91	1.00	1.00	1.00	1.00	1.00	1.00	1.00
Frt			0.850			0.850		0.892				0.850
Flt Protected	0.950			0.950			0.950			0.950		
Satd. Flow (prot)	3400	5353	1599	3467	5301	1583	1805	1623	0	1736	1845	1482
Flt Permitted	0.950			0.950			0.734			0.506		
Satd. Flow (perm)	3400	5353	1599	3467	5301	1583	1395	1623	0	924	1845	1482
Right Turn on Red			Yes			Yes			Yes			Yes
Satd. Flow (RTOR)			166			208		36				96
Link Speed (mph)		45			45			25				25
Link Distance (ft)		967			826			734				471
Travel Time (s)		14.7			12.5			20.0				12.8
Peak Hour Factor	0.95	0.95	0.95	0.95	0.95	0.95	0.95	0.95	0.95	0.95	0.95	0.95
Heavy Vehicles (%)	3%	2%	1%	1%	3%	2%	0%	8%	3%	4%	3%	9%
Shared Lane Traffic (%)												
Lane Group Flow (vph)	75	1760	166	392	1351	208	20	50	0	93	36	38
Turn Type	Prot	NA	Perm	Prot	NA	Perm	pm+pt	NA		pm+pt	NA	pm+ov
Protected Phases	5	2		1	6		3	8		7	4	5
Permitted Phases			2			6	8			4		4
Detector Phase	5	2	2	1	6	6	3	8		7	4	5
Switch Phase												
Minimum Initial (s)	3.0	15.0	15.0	3.0	15.0	15.0	3.0	8.0		3.0	8.0	3.0
Minimum Split (s)	7.5	21.0	21.0	7.5	21.0	21.0	6.5	14.0		6.5	14.0	7.5
Total Split (s)	13.0	68.0	68.0	24.0	79.0	79.0	12.0	21.0		12.0	21.0	13.0
Total Split (%)	10.4%	54.4%	54.4%	19.2%	63.2%	63.2%	9.6%	16.8%		9.6%	16.8%	10.4%
Yellow Time (s)	3.5	4.5	4.5	3.5	4.5	4.5	3.5	4.5		3.5	4.5	3.5
All-Red Time (s)	1.0	1.5	1.5	1.0	1.5	1.5	0.0	1.5		0.0	1.5	1.0
Lost Time Adjust (s)	0.0	0.0	0.0	0.0	0.0	0.0	0.0	0.0		0.0	0.0	0.0
Total Lost Time (s)	4.5	6.0	6.0	4.5	6.0	6.0	3.5	6.0		3.5	6.0	4.5
Lead/Lag	Lead	Lag	Lag	Lead	Lag	Lag	Lead	Lag		Lead	Lag	Lead
Lead-Lag Optimize?	Yes	Yes	Yes	Yes	Yes	Yes	Yes	Yes		Yes	Yes	Yes
Recall Mode	None	C-Min	C-Min	None	C-Min	C-Min	None	None		None	None	None
Act Effct Green (s)	8.1	70.9	70.9	19.1	84.0	84.0	16.0	8.9		19.8	13.9	28.1
Actuated g/C Ratio	0.06	0.57	0.57	0.15	0.67	0.67	0.13	0.07		0.16	0.11	0.22
v/c Ratio	0.34	0.58	0.17	0.74	0.38	0.18	0.10	0.34		0.46	0.18	0.09
Control Delay (s/veh)	59.6	19.6	2.8	59.2	10.6	1.7	42.5	30.2		51.8	53.1	0.4
Queue Delay	0.0	0.0	0.0	0.0	0.0	0.0	0.0	0.0		0.0	0.0	0.0
Total Delay (s/veh)	59.6	19.6	2.8	59.2	10.6	1.7	42.5	30.2		51.8	53.1	0.4
LOS	E	B	A	E	B	A	D	C		D	D	A
Approach Delay (s/veh)		19.7			19.4			33.7				40.4
Approach LOS		B			B			C				D
Queue Length 50th (ft)	31	337	0	159	182	0	14	12		68	26	0
Queue Length 95th (ft)	56	440	36	206	242	31	35	54		118	64	0

Lanes and Geometrics

3: Downers Drive & Butterfield Road

11/20/2025



Lane Group	EBL	EBT	EBR	WBL	WBT	WBR	NBL	NBT	NBR	SBL	SBT	SBR
Internal Link Dist (ft)		887			746			654			391	
Turn Bay Length (ft)	230		280	350		335						150
Base Capacity (vph)	243	3038	979	570	3562	1132	225	226		204	251	416
Starvation Cap Reductn	0	0	0	0	0	0	0	0		0	0	0
Spillback Cap Reductn	0	0	0	0	0	0	0	0		0	0	0
Storage Cap Reductn	0	0	0	0	0	0	0	0		0	0	0
Reduced v/c Ratio	0.31	0.58	0.17	0.69	0.38	0.18	0.09	0.22		0.46	0.14	0.09

Intersection Summary

Area Type:	Other
Cycle Length:	125
Actuated Cycle Length:	125
Offset:	0 (0%), Referenced to phase 2:EBT and 6:WBT, Start of Green
Natural Cycle:	60
Control Type:	Actuated-Coordinated
Maximum v/c Ratio:	0.74
Intersection Signal Delay (s/veh):	20.6
Intersection LOS:	C
Intersection Capacity Utilization	66.6%
ICU Level of Service	C
Analysis Period (min)	15

Splits and Phases: 3: Downers Drive & Butterfield Road

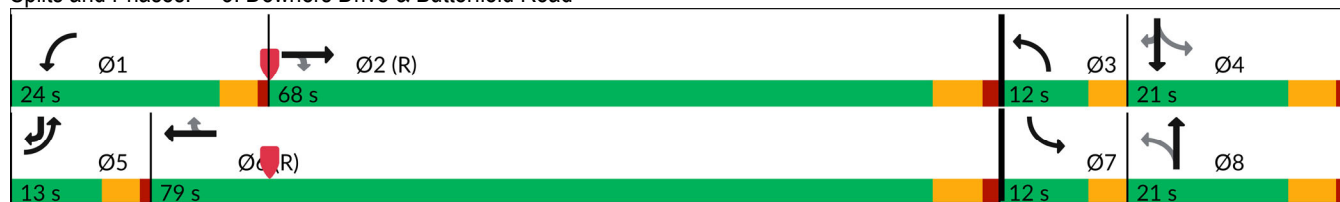

Lanes and Geometrics

8: Downers Drive & Access Road

11/20/2025



Lane Group	EBL	EBT	EBR	WBL	WBT	WBR	NBL	NBT	NBR	SBL	SBT	SBR
Lane Configurations		↕	↗	↖	↗	↖		↕			↕	↖
Traffic Volume (vph)	11	10	121	19	8	3	188	70	24	1	18	3
Future Volume (vph)	11	10	121	19	8	3	188	70	24	1	18	3
Ideal Flow (vphp)	1900	1900	1900	1900	1900	1900	1900	1900	1900	1900	1900	1900
Storage Length (ft)	0		40	0		0	0		0	0		0
Storage Lanes	0		1	1		0	0		0	0		0
Taper Length (ft)	25			25			25			25		
Lane Util. Factor	1.00	1.00	1.00	1.00	1.00	1.00	0.95	0.95	0.95	0.95	0.95	0.95
Frt			0.850		0.962			0.987			0.981	
Flt Protected		0.975		0.950				0.968			0.998	
Satd. Flow (prot)	0	1852	1599	1805	1828	0	0	3330	0	0	2772	0
Flt Permitted		0.830		0.742				0.772			0.943	
Satd. Flow (perm)	0	1577	1599	1410	1828	0	0	2656	0	0	2619	0
Right Turn on Red			Yes			Yes			Yes			Yes
Satd. Flow (RTOR)			133		3			26			3	
Link Speed (mph)		20		20				25			25	
Link Distance (ft)		252		487				471			398	
Travel Time (s)		8.6		16.6				12.8			10.9	
Peak Hour Factor	0.91	0.91	0.91	0.91	0.91	0.91	0.91	0.91	0.91	0.91	0.91	0.91
Heavy Vehicles (%)	0%	0%	1%	0%	0%	0%	2%	9%	0%	0%	33%	0%
Shared Lane Traffic (%)												
Lane Group Flow (vph)	0	23	133	21	12	0	0	310	0	0	24	0
Turn Type	Perm	NA	Perm	Perm	NA		Perm	NA		Perm	NA	
Protected Phases		4			8			2			6	
Permitted Phases	4		4	8			2			6		
Detector Phase	4	4	4	8	8		2	2		6	6	
Switch Phase												
Minimum Initial (s)	8.0	8.0	8.0	8.0	8.0		15.0	15.0		15.0	15.0	
Minimum Split (s)	14.0	14.0	14.0	14.0	14.0		24.0	24.0		24.0	24.0	
Total Split (s)	14.0	14.0	14.0	14.0	14.0		66.0	66.0		66.0	66.0	
Total Split (%)	17.5%	17.5%	17.5%	17.5%	17.5%		82.5%	82.5%		82.5%	82.5%	
Yellow Time (s)	4.5	4.5	4.5	4.5	4.5		4.5	4.5		4.5	4.5	
All-Red Time (s)	1.5	1.5	1.5	1.5	1.5		1.5	1.5		1.5	1.5	
Lost Time Adjust (s)		0.0	0.0	0.0	0.0			0.0			0.0	
Total Lost Time (s)		6.0	6.0	6.0	6.0			6.0			6.0	
Lead/Lag												
Lead-Lag Optimize?												
Recall Mode	None	None	None	None	None		Min	Min		Min	Min	
Act Effct Green (s)		8.0	8.0	8.0	8.0			21.7			21.7	
Actuated g/C Ratio		0.21	0.21	0.21	0.21			0.58			0.58	
v/c Ratio		0.07	0.30	0.07	0.03			0.20			0.02	
Control Delay (s/veh)		13.6	5.9	13.6	12.0			5.5			4.9	
Queue Delay		0.0	0.0	0.0	0.0			0.0			0.0	
Total Delay (s/veh)		13.6	5.9	13.6	12.0			5.5			4.9	
LOS		B	A	B	B			A			A	
Approach Delay (s/veh)		7.0			13.0			5.5			4.9	
Approach LOS		A			B			A			A	
Queue Length 50th (ft)		4	0	3	1			17			1	
Queue Length 95th (ft)		18	31	17	11			33			5	

Lanes and Geometrics

8: Downers Drive & Access Road

11/20/2025

Lane Group	EBL	EBT	EBR	WBL	WBT	WBR	NBL	NBT	NBR	SBL	SBT	SBR
Internal Link Dist (ft)		172			407			391			318	
Turn Bay Length (ft)			40									
Base Capacity (vph)		336	446	301	392			2656			2619	
Starvation Cap Reductn		0	0	0	0			0			0	
Spillback Cap Reductn		0	0	0	0			0			0	
Storage Cap Reductn		0	0	0	0			0			0	
Reduced v/c Ratio		0.07	0.30	0.07	0.03			0.12			0.01	

Intersection Summary

Area Type:	Other
Cycle Length:	80
Actuated Cycle Length:	37.6
Natural Cycle:	40
Control Type:	Actuated-Uncoordinated
Maximum v/c Ratio:	0.30
Intersection Signal Delay (s/veh):	6.4
Intersection LOS:	A
Intersection Capacity Utilization:	41.7%
ICU Level of Service:	A
Analysis Period (min):	15

Splits and Phases: 8: Downers Drive & Access Road

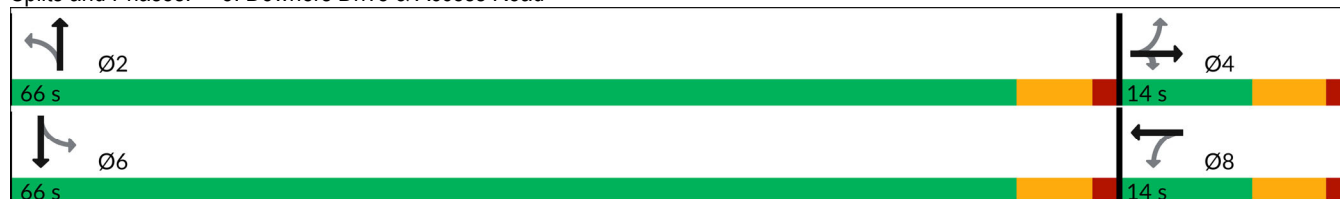

HCM 7th TWSC

7: Butterfield Road & Right-I/Right-Out Access Drive

11/19/2025

Intersection						
Int Delay, s/veh	0					
Movement	EBL	EBT	WBT	WBR	SBL	SBR
Lane Configurations		↑↑	↑↑↑			↑
Traffic Vol, veh/h	0	1794	1846	21	0	7
Future Vol, veh/h	0	1794	1846	21	0	7
Conflicting Peds, #/hr	0	0	0	0	0	0
Sign Control	Free	Free	Free	Free	Stop	Stop
RT Channelized	-	None	-	Free	-	Stop
Storage Length	-	-	-	-	-	0
Veh in Median Storage, #	-	0	0	-	0	-
Grade, %	-	0	0	-	0	-
Peak Hour Factor	95	95	95	95	95	95
Heavy Vehicles, %	0	2	2	0	0	14
Mvmt Flow	0	1888	1943	22	0	7

Major/Minor	Major1	Major2	Minor2
Conflicting Flow All	-	0	-
Stage 1	-	-	-
Stage 2	-	-	-
Critical Hdwy	-	-	-
Critical Hdwy Stg 1	-	-	-
Critical Hdwy Stg 2	-	-	-
Follow-up Hdwy	-	-	-
Pot Cap-1 Maneuver	0	-	-
Stage 1	0	-	-
Stage 2	0	-	-
Platoon blocked, %	-	-	-
Mov Cap-1 Maneuver	-	-	-
Mov Cap-2 Maneuver	-	-	-
Stage 1	-	-	-
Stage 2	-	-	-

















Approach	EB	WB	SB
HCM Ctrl Dly, s/v	0	0	23.72
HCM LOS			C

Minor Lane/Major Mvmt	EBT	WBT	SBLn1
Capacity (veh/h)	-	-	200
HCM Lane V/C Ratio	-	-	0.037
HCM Ctrl Dly (s/v)	-	-	23.7
HCM Lane LOS	-	-	C
HCM 95th %tile Q(veh)	-	-	0.1

Capacity Analysis Summary Sheets
Existing Weekday Evening Peak Hour

Intersection Capacity Utilization 12: Access Drive & Access Road

11/19/2025

												
Movement	EBL	EBT	EBR	WBL	WBT	WBR	NBL	NBT	NBR	SBL	SBT	SBR
Lane Configurations												
Volume (vph)	3	72	4	10	152	0	3	0	4	0	0	1
Pedestrians												
Ped Button												
Pedestrian Timing (s)												
Free Right			No			No			No			No
Ideal Flow	1900	1900	1900	1900	1900	1900	1900	1900	1900	1900	1900	1900
Lost Time (s)	4.0	4.0	4.0	4.0	4.0	4.0	4.0	4.0	4.0	4.0	4.0	4.0
Minimum Green (s)	4.0	4.0	4.0	4.0	4.0	4.0	4.0	4.0	4.0	4.0	4.0	4.0
Refr Cycle Length (s)	120	120	120	120	120	120	120	120	120	120	120	120
Volume Combined (vph)	0	79	0	0	162	0	0	7	0	0	1	0
Lane Utilization Factor	1.00	1.00	1.00	1.00	1.00	1.00	1.00	1.00	1.00	1.00	1.00	1.00
Turning Factor (vph)	0.95	0.99	0.85	0.95	1.00	0.85	0.95	0.89	0.85	0.95	0.85	0.85
Saturated Flow (vph)	0	1882	0	0	1894	0	0	1700	0	0	1615	0
Ped Intf Time (s)	0.0	0.0	0.0	0.0	0.0	0.0	0.0	0.0	0.0	0.0	0.0	0.0
Pedestrian Frequency (%)		0.00			0.00			0.00			0.00	
Protected Option Allowed		No			No			No			No	
Reference Time (s)			0.0			0.0			0.0			0.0
Adj Reference Time (s)			0.0			0.0			0.0			0.0
Permitted Option												
Adj Saturation A (vph)	0	1607		0	1353		0	222		0	1615	
Reference Time A (s)	0.0	5.9		0.0	14.4		0.0	3.8		0.0	0.1	
Adj Saturation B (vph)	NA	NA		0	0		0	0		0	1615	
Reference Time B (s)	NA	NA		8.7	18.3		8.2	8.5		0.0	0.1	
Reference Time (s)		5.9			14.4			3.8			0.1	
Adj Reference Time (s)		9.9			18.4			8.0			8.0	
Split Option												
Ref Time Combined (s)	0.0	5.0		0.0	10.3		0.0	0.5		0.0	0.1	
Ref Time Seperate (s)	0.2	4.6		0.7	9.6		0.2	0.0		0.0	0.0	
Reference Time (s)	5.0	5.0		10.3	10.3		0.5	0.5		0.1	0.1	
Adj Reference Time (s)	9.0	9.0		14.3	14.3		8.0	8.0		8.0	8.0	
Summary												
	EB WB		NB SB		Combined							
Protected Option (s)	NA		NA									
Permitted Option (s)	18.4		8.0									
Split Option (s)	23.3		16.0									
Minimum (s)	18.4		8.0		26.4							
Right Turns												
Adj Reference Time (s)												
Cross Thru Ref Time (s)												
Oncoming Left Ref Time (s)												
Combined (s)												
Intersection Summary												
Intersection Capacity Utilization			22.0%		ICU Level of Service		A					
Reference Times and Phasing Options do not represent an optimized timing plan.												

Lanes and Geometrics

3: Downers Drive & Butterfield Road

11/20/2025

Lane Group	EBL	EBT	EBR	WBL	WBT	WBR	NBL	NBT	NBR	SBL	SBT	SBR
Lane Configurations												
Traffic Volume (vph)	93	1531	102	777	1863	230	99	29	117	278	66	124
Future Volume (vph)	93	1531	102	777	1863	230	99	29	117	278	66	124
Ideal Flow (vphp)	1900	2000	1900	1900	2000	1900	1900	1900	1900	1900	1900	1900
Storage Length (ft)	230		280	350		335	0		0	0		150
Storage Lanes	2		1	2		1	1		0	1		1
Taper Length (ft)	300			300			25			0		
Lane Util. Factor	0.97	0.91	1.00	0.97	0.91	1.00	1.00	1.00	1.00	1.00	1.00	1.00
Frt			0.850			0.850		0.880				0.850
Flt Protected	0.950			0.950			0.950			0.950		
Satd. Flow (prot)	3400	5353	1599	3467	5406	1615	1805	1672	0	1787	1845	1599
Flt Permitted	0.950			0.950			0.712			0.278		
Satd. Flow (perm)	3400	5353	1599	3467	5406	1615	1353	1672	0	523	1845	1599
Right Turn on Red			Yes			Yes			Yes			Yes
Satd. Flow (RTOR)			154			240		120				89
Link Speed (mph)		45			45			25				25
Link Distance (ft)		967			826			734				471
Travel Time (s)		14.7			12.5			20.0				12.8
Peak Hour Factor	0.96	0.96	0.96	0.96	0.96	0.96	0.96	0.96	0.96	0.96	0.96	0.96
Heavy Vehicles (%)	3%	2%	1%	1%	1%	0%	0%	0%	0%	1%	3%	1%
Shared Lane Traffic (%)												
Lane Group Flow (vph)	97	1595	106	809	1941	240	103	152	0	290	69	129
Turn Type	Prot	NA	Perm	Prot	NA	Perm	pm+pt	NA		pm+pt	NA	pm+ov
Protected Phases	5	2		1	6		3	8		7	4	5
Permitted Phases			2			6	8			4		4
Detector Phase	5	2	2	1	6	6	3	8		7	4	5
Switch Phase												
Minimum Initial (s)	3.0	15.0	15.0	3.0	15.0	15.0	3.0	8.0		3.0	8.0	3.0
Minimum Split (s)	7.5	21.0	21.0	7.5	21.0	21.0	6.5	14.0		6.5	14.0	7.5
Total Split (s)	13.0	49.0	49.0	44.0	80.0	80.0	14.0	19.0		23.0	28.0	13.0
Total Split (%)	9.6%	36.3%	36.3%	32.6%	59.3%	59.3%	10.4%	14.1%		17.0%	20.7%	9.6%
Yellow Time (s)	3.5	4.5	4.5	3.5	4.5	4.5	3.5	4.5		3.5	4.5	3.5
All-Red Time (s)	1.0	1.5	1.5	1.0	1.5	1.5	0.0	1.5		0.0	1.5	1.0
Lost Time Adjust (s)	0.0	0.0	0.0	0.0	0.0	0.0	0.0	0.0		0.0	0.0	0.0
Total Lost Time (s)	4.5	6.0	6.0	4.5	6.0	6.0	3.5	6.0		3.5	6.0	4.5
Lead/Lag	Lead	Lag	Lag	Lead	Lag	Lag	Lead	Lag		Lead	Lag	Lead
Lead-Lag Optimize?	Yes	Yes	Yes	Yes	Yes	Yes	Yes	Yes		Yes	Yes	Yes
Recall Mode	None	C-Min	C-Min	None	C-Min	C-Min	None	None		None	None	None
Act Effct Green (s)	8.6	49.7	49.7	36.2	77.3	77.3	25.0	9.6		32.3	17.0	28.7
Actuated g/C Ratio	0.06	0.37	0.37	0.27	0.57	0.57	0.19	0.07		0.24	0.13	0.21
v/c Ratio	0.45	0.81	0.15	0.87	0.63	0.23	0.34	0.66		0.94	0.30	0.31
Control Delay (s/veh)	67.6	43.1	1.7	58.1	20.7	2.3	42.7	30.5		85.1	55.3	16.1
Queue Delay	0.0	0.0	0.0	0.0	0.0	0.0	0.0	0.0		0.0	0.0	0.0
Total Delay (s/veh)	67.6	43.1	1.7	58.1	20.7	2.3	42.7	30.5		85.1	55.3	16.1
LOS	E	D	A	E	C	A	D	C		F	E	B
Approach Delay (s/veh)		42.0			29.3			35.4			62.7	
Approach LOS		D			C			D			E	
Queue Length 50th (ft)	43	464	0	349	395	0	72	27		231	57	28
Queue Length 95th (ft)	75	#601	12	420	478	39	118	98		#346	103	80

Lanes and Geometrics

3: Downers Drive & Butterfield Road

11/20/2025

Lane Group	EBL	EBT	EBR	WBL	WBT	WBR	NBL	NBT	NBR	SBL	SBT	SBR
Internal Link Dist (ft)		887			746			654			391	
Turn Bay Length (ft)	230		280	350		335						150
Base Capacity (vph)	226	1970	686	1016	3094	1026	302	269		307	300	415
Starvation Cap Reductn	0	0	0	0	0	0	0	0		0	0	0
Spillback Cap Reductn	0	0	0	0	0	0	0	0		0	0	0
Storage Cap Reductn	0	0	0	0	0	0	0	0		0	0	0
Reduced v/c Ratio	0.43	0.81	0.15	0.80	0.63	0.23	0.34	0.57		0.94	0.23	0.31

Intersection Summary

Area Type: Other
 Cycle Length: 135
 Actuated Cycle Length: 135
 Offset: 63 (47%), Referenced to phase 2:EBT and 6:WBT, Start of Green
 Natural Cycle: 90
 Control Type: Actuated-Coordinated
 Maximum v/c Ratio: 0.94
 Intersection Signal Delay (s/veh): 36.7 Intersection LOS: D
 Intersection Capacity Utilization 91.5% ICU Level of Service F
 Analysis Period (min) 15
 # 95th percentile volume exceeds capacity, queue may be longer.
 Queue shown is maximum after two cycles.

Splits and Phases: 3: Downers Drive & Butterfield Road

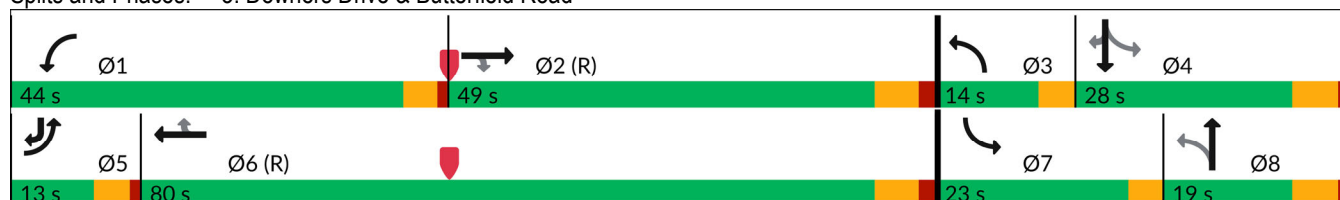

Lanes and Geometrics

8: Downers Drive & Access Road

11/20/2025



Lane Group	EBL	EBT	EBR	WBL	WBT	WBR	NBL	NBT	NBR	SBL	SBT	SBR
Lane Configurations		↕	↗	↖	↗	↖		↕			↕	
Traffic Volume (vph)	3	55	243	142	45	12	250	25	77	7	83	7
Future Volume (vph)	3	55	243	142	45	12	250	25	77	7	83	7
Ideal Flow (vphp)	1900	1900	1900	1900	1900	1900	1900	1900	1900	1900	1900	1900
Storage Length (ft)	0		40	0		0	0		0	0		0
Storage Lanes	0		1	1		0	0		0	0		0
Taper Length (ft)	25			25			25			25		
Lane Util. Factor	1.00	1.00	1.00	1.00	1.00	1.00	0.95	0.95	0.95	0.95	0.95	0.95
Frt			0.850		0.969			0.967			0.989	
Flt Protected		0.998		0.950				0.966			0.996	
Satd. Flow (prot)	0	1896	1615	1787	1841	0	0	3346	0	0	3384	0
Flt Permitted		0.986		0.716				0.726			0.923	
Satd. Flow (perm)	0	1873	1615	1347	1841	0	0	2515	0	0	3136	0
Right Turn on Red			Yes			Yes			Yes			Yes
Satd. Flow (RTOR)			264		13			84			8	
Link Speed (mph)		20		20				25			25	
Link Distance (ft)		252		487				471			398	
Travel Time (s)		8.6		16.6				12.8			10.9	
Peak Hour Factor	0.92	0.92	0.92	0.92	0.92	0.92	0.92	0.92	0.92	0.92	0.92	0.92
Heavy Vehicles (%)	0%	0%	0%	1%	0%	0%	0%	8%	1%	0%	6%	0%
Shared Lane Traffic (%)												
Lane Group Flow (vph)	0	63	264	154	62	0	0	383	0	0	106	0
Turn Type	Perm	NA	Perm	Perm	NA		Perm	NA		Perm	NA	
Protected Phases		4			8			2			6	
Permitted Phases	4		4	8			2			6		
Detector Phase	4	4	4	8	8		2	2		6	6	
Switch Phase												
Minimum Initial (s)	8.0	8.0	8.0	8.0	8.0		8.0	8.0		8.0	8.0	
Minimum Split (s)	14.0	14.0	14.0	14.0	14.0		14.0	14.0		14.0	14.0	
Total Split (s)	20.0	20.0	20.0	20.0	20.0		40.0	40.0		40.0	40.0	
Total Split (%)	33.3%	33.3%	33.3%	33.3%	33.3%		66.7%	66.7%		66.7%	66.7%	
Yellow Time (s)	4.5	4.5	4.5	4.5	4.5		4.5	4.5		4.5	4.5	
All-Red Time (s)	1.5	1.5	1.5	1.5	1.5		1.5	1.5		1.5	1.5	
Lost Time Adjust (s)		0.0	0.0	0.0	0.0			0.0			0.0	
Total Lost Time (s)		6.0	6.0	6.0	6.0			6.0			6.0	
Lead/Lag												
Lead-Lag Optimize?												
Recall Mode	None	None	None	None	None		Min	Min		Min	Min	
Act Effct Green (s)		10.9	10.9	10.9	10.9			20.0			20.0	
Actuated g/C Ratio		0.25	0.25	0.25	0.25			0.46			0.46	
v/c Ratio		0.13	0.44	0.46	0.13			0.32			0.07	
Control Delay (s/veh)		15.2	5.5	20.4	13.0			6.4			6.2	
Queue Delay		0.0	0.0	0.0	0.0			0.0			0.0	
Total Delay (s/veh)		15.2	5.5	20.4	13.0			6.4			6.2	
LOS		B	A	C	B			A			A	
Approach Delay (s/veh)		7.3			18.2			6.4			6.2	
Approach LOS		A			B			A			A	
Queue Length 50th (ft)		11	0	30	8			22			6	
Queue Length 95th (ft)		42	47	93	38			47			17	

Lanes and Geometrics

8: Downers Drive & Access Road

11/20/2025

Lane Group	EBL	EBT	EBR	WBL	WBT	WBR	NBL	NBT	NBR	SBL	SBT	SBR
Internal Link Dist (ft)		172			407			391			318	
Turn Bay Length (ft)			40									
Base Capacity (vph)		626	715	450	624			2057			2547	
Starvation Cap Reductn		0	0	0	0			0			0	
Spillback Cap Reductn		0	0	0	0			0			0	
Storage Cap Reductn		0	0	0	0			0			0	
Reduced v/c Ratio		0.10	0.37	0.34	0.10			0.19			0.04	

Intersection Summary

Area Type:	Other
Cycle Length:	60
Actuated Cycle Length:	43.3
Natural Cycle:	40
Control Type:	Actuated-Uncoordinated
Maximum v/c Ratio:	0.46
Intersection Signal Delay (s/veh):	9.1
Intersection LOS:	A
Intersection Capacity Utilization:	45.1%
ICU Level of Service:	A
Analysis Period (min):	15

Splits and Phases: 8: Downers Drive & Access Road

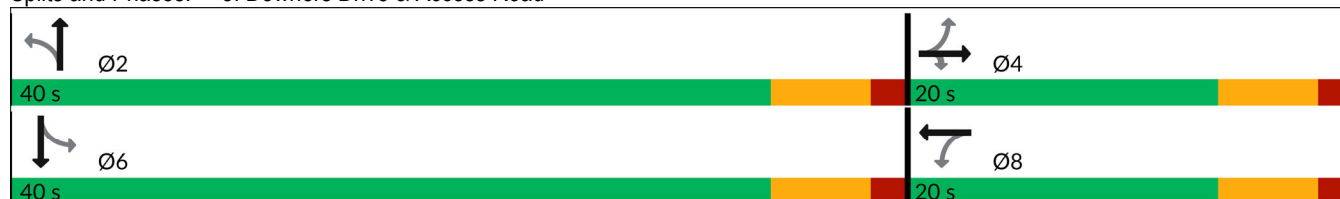

HCM 7th TWSC

7: Butterfield Road & Right-I/Right-Out Access Drive

11/19/2025

Intersection						
Int Delay, s/veh	0.5					
Movement	EBL	EBT	WBT	WBR	SBL	SBR
Lane Configurations		↑↑	↑↑↑			↑
Traffic Vol, veh/h	0	1926	2835	105	0	35
Future Vol, veh/h	0	1926	2835	105	0	35
Conflicting Peds, #/hr	0	0	0	0	0	0
Sign Control	Free	Free	Free	Free	Stop	Stop
RT Channelized	-	None	-	Free	-	Stop
Storage Length	-	-	-	-	-	0
Veh in Median Storage, #	-	0	0	-	0	-
Grade, %	-	0	0	-	0	-
Peak Hour Factor	95	95	95	95	95	95
Heavy Vehicles, %	0	1	1	0	0	0
Mvmt Flow	0	2027	2984	111	0	37

Major/Minor	Major1	Major2	Minor2
Conflicting Flow All	-	0	- 0 - 1492
Stage 1	-	-	- - -
Stage 2	-	-	- - -
Critical Hdwy	-	-	- - 7.1
Critical Hdwy Stg 1	-	-	- - -
Critical Hdwy Stg 2	-	-	- - -
Follow-up Hdwy	-	-	- - 3.9
Pot Cap-1 Maneuver	0	-	- 0 0 98
Stage 1	0	-	- 0 0 -
Stage 2	0	-	- 0 0 -
Platoon blocked, %	-	-	
Mov Cap-1 Maneuver	-	-	- - 98
Mov Cap-2 Maneuver	-	-	- - -
Stage 1	-	-	- - -
Stage 2	-	-	- - -

Approach	EB	WB	SB
HCM Ctrl Dly, s/v	0	0	62.21
HCM LOS			F

Minor Lane/Major Mvmt	EBT	WBT	SBLn1
Capacity (veh/h)	-	-	98
HCM Lane V/C Ratio	-	-	0.375
HCM Ctrl Dly (s/v)	-	-	62.2
HCM Lane LOS	-	-	F
HCM 95th %tile Q(veh)	-	-	1.5

Capacity Analysis Summary Sheets
Existing Saturday Midday Peak Hour

Intersection Capacity Utilization 12: Access Drive & Access Road

11/19/2025



Movement	EBL	EBT	EBR	WBL	WBT	WBR	NBL	NBT	NBR	SBL	SBT	SBR
Lane Configurations		↕			↕			↕			↕	
Volume (vph)	2	138	12	12	197	1	2	0	5	2	0	0
Pedestrians												
Ped Button												
Pedestrian Timing (s)												
Free Right	No			No			No			No		
Ideal Flow	1900	1900	1900	1900	1900	1900	1900	1900	1900	1900	1900	1900
Lost Time (s)	4.0	4.0	4.0	4.0	4.0	4.0	4.0	4.0	4.0	4.0	4.0	4.0
Minimum Green (s)	4.0	4.0	4.0	4.0	4.0	4.0	4.0	4.0	4.0	4.0	4.0	4.0
Refr Cycle Length (s)	120	120	120	120	120	120	120	120	120	120	120	120
Volume Combined (vph)	0	152	0	0	210	0	0	7	0	0	2	0
Lane Utilization Factor	1.00	1.00	1.00	1.00	1.00	1.00	1.00	1.00	1.00	1.00	1.00	1.00
Turning Factor (vph)	0.95	0.99	0.85	0.95	1.00	0.85	0.95	0.88	0.85	0.95	0.95	0.85
Saturated Flow (vph)	0	1876	0	0	1893	0	0	1672	0	0	1805	0
Ped Intf Time (s)	0.0	0.0	0.0	0.0	0.0	0.0	0.0	0.0	0.0	0.0	0.0	0.0
Pedestrian Frequency (%)	0.00		0.00			0.00			0.00		0.00	
Protected Option Allowed	No		No			No			No		No	
Reference Time (s)	0.0		0.0			0.0			0.0		0.0	
Adj Reference Time (s)	0.0		0.0			0.0			0.0		0.0	
Permitted Option												
Adj Saturation A (vph)	0	1769	0	0	1194	0	0	1843	0	0	636	0
Reference Time A (s)	0.0	10.3	0.0	0.0	21.1	0.0	0.0	0.5	0.0	0.0	0.4	0.4
Adj Saturation B (vph)	NA	NA	NA	NA	NA	0	0	0	0	0	0	0
Reference Time B (s)	NA	NA	NA	NA	NA	8.1	8.5	8.1	8.1	8.1	8.1	8.1
Reference Time (s)	10.3		21.1			0.5			0.4		0.4	
Adj Reference Time (s)	14.3		25.1			8.0			8.0		8.0	
Split Option												
Ref Time Combined (s)	0.0	9.7	0.0	0.0	13.3	0.0	0.0	0.5	0.0	0.0	0.1	0.1
Ref Time Seperate (s)	0.1	8.8	0.8	0.8	12.5	0.1	0.1	0.0	0.1	0.1	0.0	0.0
Reference Time (s)	9.7	9.7	13.3	13.3	13.3	0.5	0.5	0.5	0.1	0.1	0.1	0.1
Adj Reference Time (s)	13.7	13.7	17.3	17.3	17.3	8.0	8.0	8.0	8.0	8.0	8.0	8.0
Summary	EB WB		NB SB		Combined							
Protected Option (s)	NA		NA									
Permitted Option (s)	25.1		8.0									
Split Option (s)	31.0		16.0									
Minimum (s)	25.1		8.0		33.1							
Right Turns												
Adj Reference Time (s)												
Cross Thru Ref Time (s)												
Oncoming Left Ref Time (s)												
Combined (s)												
Intersection Summary												
Intersection Capacity Utilization	27.6%		ICU Level of Service		A							
Reference Times and Phasing Options do not represent an optimized timing plan.												

Lanes and Geometrics

3: Downers Drive & Butterfield Road

11/20/2025

Lane Group	EBL	EBT	EBR	WBL	WBT	WBR	NBL	NBT	NBR	SBL	SBT	SBR
Lane Configurations												
Traffic Volume (vph)	142	1157	28	414	1388	339	52	34	38	282	70	174
Future Volume (vph)	142	1157	28	414	1388	339	52	34	38	282	70	174
Ideal Flow (vphp)	1900	2000	1900	1900	2000	1900	1900	1900	1900	1900	1900	1900
Storage Length (ft)	230		280	350		335	0		0	0		150
Storage Lanes	2		1	2		1	1		0	1		1
Taper Length (ft)	300			300			25			0		
Lane Util. Factor	0.97	0.91	1.00	0.97	0.91	1.00	1.00	1.00	1.00	1.00	1.00	1.00
Frt			0.850			0.850		0.921				0.850
Flt Protected	0.950			0.950			0.950			0.950		
Satd. Flow (prot)	3467	5460	1615	3467	5406	1615	1805	1723	0	1787	1863	1615
Flt Permitted	0.950			0.950			0.711			0.520		
Satd. Flow (perm)	3467	5460	1615	3467	5406	1615	1351	1723	0	978	1863	1615
Right Turn on Red			Yes			Yes			Yes			Yes
Satd. Flow (RTOR)			207			342		38				176
Link Speed (mph)		45			45			25				25
Link Distance (ft)		967			826			734				471
Travel Time (s)		14.7			12.5			20.0				12.8
Peak Hour Factor	0.99	0.99	0.99	0.99	0.99	0.99	0.99	0.99	0.99	0.99	0.99	0.99
Heavy Vehicles (%)	1%	0%	0%	1%	1%	0%	0%	0%	3%	1%	2%	0%
Shared Lane Traffic (%)												
Lane Group Flow (vph)	143	1169	28	418	1402	342	53	72	0	285	71	176
Turn Type	Prot	NA	Perm	Prot	NA	Perm	pm+pt	NA		pm+pt	NA	pm+ov
Protected Phases	5	2		1	6		3	8		7	4	5
Permitted Phases			2			6	8			4		4
Detector Phase	5	2	2	1	6	6	3	8		7	4	5
Switch Phase												
Minimum Initial (s)	3.0	15.0	15.0	3.0	15.0	15.0	3.0	8.0		3.0	8.0	3.0
Minimum Split (s)	7.5	21.0	21.0	7.5	21.0	21.0	6.5	14.0		6.5	14.0	7.5
Total Split (s)	13.0	38.0	38.0	21.0	46.0	46.0	15.0	20.0		21.0	26.0	13.0
Total Split (%)	13.0%	38.0%	38.0%	21.0%	46.0%	46.0%	15.0%	20.0%		21.0%	26.0%	13.0%
Yellow Time (s)	3.5	4.5	4.5	3.5	4.5	4.5	3.5	4.5		3.5	4.5	3.5
All-Red Time (s)	1.0	1.5	1.5	1.0	1.5	1.5	0.0	1.5		0.0	1.5	1.0
Lost Time Adjust (s)	0.0	0.0	0.0	0.0	0.0	0.0	0.0	0.0		0.0	0.0	0.0
Total Lost Time (s)	4.5	6.0	6.0	4.5	6.0	6.0	3.5	6.0		3.5	6.0	4.5
Lead/Lag	Lead	Lag	Lag	Lead	Lag	Lag	Lead	Lag		Lead	Lag	Lead
Lead-Lag Optimize?	Yes	Yes	Yes	Yes	Yes	Yes	Yes	Yes		Yes	Yes	Yes
Recall Mode	None	C-Min	C-Min	None	C-Min	C-Min	None	None		None	None	None
Act Effct Green (s)	8.6	39.0	39.0	15.9	46.4	46.4	19.0	11.5		31.0	19.4	34.0
Actuated g/C Ratio	0.09	0.39	0.39	0.16	0.46	0.46	0.19	0.12		0.31	0.19	0.34
v/c Ratio	0.48	0.55	0.04	0.76	0.56	0.37	0.18	0.31		0.65	0.20	0.26
Control Delay (s/veh)	49.1	26.7	0.1	49.6	22.1	3.4	23.6	25.5		34.4	33.8	4.4
Queue Delay	0.0	0.0	0.0	0.0	0.0	0.0	0.0	0.0		0.0	0.0	0.0
Total Delay (s/veh)	49.1	26.7	0.1	49.6	22.1	3.4	23.6	25.5		34.4	33.8	4.4
LOS	D	C	A	D	C	A	C	C		C	C	A
Approach Delay (s/veh)		28.5			24.5			24.7			24.4	
Approach LOS		C			C			C			C	
Queue Length 50th (ft)	45	227	0	131	253	0	22	20		141	38	0
Queue Length 95th (ft)	77	284	0	186	313	54	47	60		209	76	43

Lanes and Geometrics

3: Downers Drive & Butterfield Road

11/20/2025

Lane Group	EBL	EBT	EBR	WBL	WBT	WBR	NBL	NBT	NBR	SBL	SBT	SBR
Internal Link Dist (ft)		887			746			654			391	
Turn Bay Length (ft)	230		280	350		335						150
Base Capacity (vph)	309	2131	756	585	2506	932	364	273		451	392	669
Starvation Cap Reductn	0	0	0	0	0	0	0	0		0	0	0
Spillback Cap Reductn	0	0	0	0	0	0	0	0		0	0	0
Storage Cap Reductn	0	0	0	0	0	0	0	0		0	0	0
Reduced v/c Ratio	0.46	0.55	0.04	0.71	0.56	0.37	0.15	0.26		0.63	0.18	0.26

Intersection Summary

Area Type:	Other
Cycle Length:	100
Actuated Cycle Length:	100
Offset:	0 (0%), Referenced to phase 2:EBT and 6:WBT, Start of Green
Natural Cycle:	60
Control Type:	Actuated-Coordinated
Maximum v/c Ratio:	0.76
Intersection Signal Delay (s/veh):	25.8
Intersection LOS:	C
Intersection Capacity Utilization:	69.1%
ICU Level of Service:	C
Analysis Period (min):	15

Splits and Phases: 3: Downers Drive & Butterfield Road

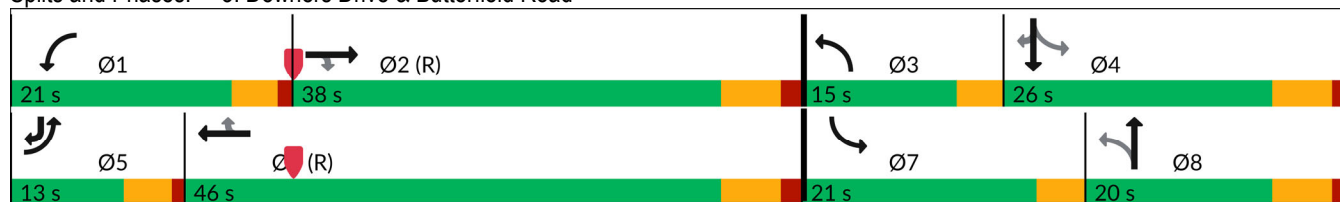

Lanes and Geometrics

8: Downers Drive & Access Road

11/20/2025



Lane Group	EBL	EBT	EBR	WBL	WBT	WBR	NBL	NBT	NBR	SBL	SBT	SBR
Lane Configurations		↕	↗	↖	↘			↕			↕	
Traffic Volume (vph)	5	96	310	206	73	17	353	8	154	3	10	6
Future Volume (vph)	5	96	310	206	73	17	353	8	154	3	10	6
Ideal Flow (vphp)	1900	1900	1900	1900	1900	1900	1900	1900	1900	1900	1900	1900
Storage Length (ft)	0		40	0		0	0		0	0		0
Storage Lanes	0		1	1		0	0		0	0		0
Taper Length (ft)	25			25			25			25		
Lane Util. Factor	1.00	1.00	1.00	1.00	1.00	1.00	0.95	0.95	0.95	0.95	0.95	0.95
Frt			0.850		0.971			0.955			0.953	
Flt Protected		0.998		0.950				0.967			0.992	
Satd. Flow (prot)	0	1896	1615	1805	1845	0	0	3321	0	0	2947	0
Flt Permitted		0.984		0.689				0.775			0.883	
Satd. Flow (perm)	0	1870	1615	1309	1845	0	0	2662	0	0	2624	0
Right Turn on Red			Yes			Yes			Yes			Yes
Satd. Flow (RTOR)			323		18			160			6	
Link Speed (mph)		20		20				25			25	
Link Distance (ft)		252		487				471			398	
Travel Time (s)		8.6		16.6				12.8			10.9	
Peak Hour Factor	0.96	0.96	0.96	0.96	0.96	0.96	0.96	0.96	0.96	0.96	0.96	0.96
Heavy Vehicles (%)	0%	0%	0%	0%	0%	0%	0%	25%	0%	0%	30%	0%
Shared Lane Traffic (%)												
Lane Group Flow (vph)	0	105	323	215	94	0	0	536	0	0	19	0
Turn Type	Perm	NA	Perm	Perm	NA		Perm	NA		Perm	NA	
Protected Phases		4			8			2			6	
Permitted Phases	4		4	8			2			6		
Detector Phase	4	4	4	8	8		2	2		6	6	
Switch Phase												
Minimum Initial (s)	8.0	8.0	8.0	5.0	5.0		8.0	8.0		8.0	8.0	
Minimum Split (s)	14.0	14.0	14.0	14.0	14.0		14.0	14.0		14.0	14.0	
Total Split (s)	20.0	20.0	20.0	20.0	20.0		40.0	40.0		40.0	40.0	
Total Split (%)	33.3%	33.3%	33.3%	33.3%	33.3%		66.7%	66.7%		66.7%	66.7%	
Yellow Time (s)	4.5	4.5	4.5	4.5	4.5		4.5	4.5		4.5	4.5	
All-Red Time (s)	1.5	1.5	1.5	1.5	1.5		1.5	1.5		1.5	1.5	
Lost Time Adjust (s)		0.0	0.0	0.0	0.0			0.0			0.0	
Total Lost Time (s)		6.0	6.0	6.0	6.0			6.0			6.0	
Lead/Lag												
Lead-Lag Optimize?												
Recall Mode	None	None	None	None	None		Min	Min		Min	Min	
Act Effct Green (s)		11.6	11.6	11.6	11.6			15.5			15.5	
Actuated g/C Ratio		0.29	0.29	0.29	0.29			0.39			0.39	
v/c Ratio		0.19	0.46	0.56	0.17			0.47			0.02	
Control Delay (s/veh)		13.4	4.7	20.9	11.4			7.4			6.1	
Queue Delay		0.0	0.0	0.0	0.0			0.0			0.0	
Total Delay (s/veh)		13.4	4.7	20.9	11.4			7.4			6.1	
LOS		B	A	C	B			A			A	
Approach Delay (s/veh)		6.9			18.0			7.4			6.1	
Approach LOS		A			B			A			A	
Queue Length 50th (ft)		17	0	39	12			34			1	
Queue Length 95th (ft)		55	47	#131	46			69			6	

Lanes and Geometrics

8: Downers Drive & Access Road

11/20/2025

Lane Group	EBL	EBT	EBR	WBL	WBT	WBR	NBL	NBT	NBR	SBL	SBT	SBR
Internal Link Dist (ft)		172			407			391			318	
Turn Bay Length (ft)			40									
Base Capacity (vph)		691	800	483	692			2295			2240	
Starvation Cap Reductn		0	0	0	0			0			0	
Spillback Cap Reductn		0	0	0	0			0			0	
Storage Cap Reductn		0	0	0	0			0			0	
Reduced v/c Ratio		0.15	0.40	0.45	0.14			0.23			0.01	

Intersection Summary

Area Type:	Other
Cycle Length:	60
Actuated Cycle Length:	39.7
Natural Cycle:	40
Control Type:	Actuated-Uncoordinated
Maximum v/c Ratio:	0.56
Intersection Signal Delay (s/veh):	9.8
Intersection LOS:	A
Intersection Capacity Utilization:	54.3%
ICU Level of Service:	A
Analysis Period (min):	15
# 95th percentile volume exceeds capacity, queue may be longer.	
Queue shown is maximum after two cycles.	

Splits and Phases: 8: Downers Drive & Access Road

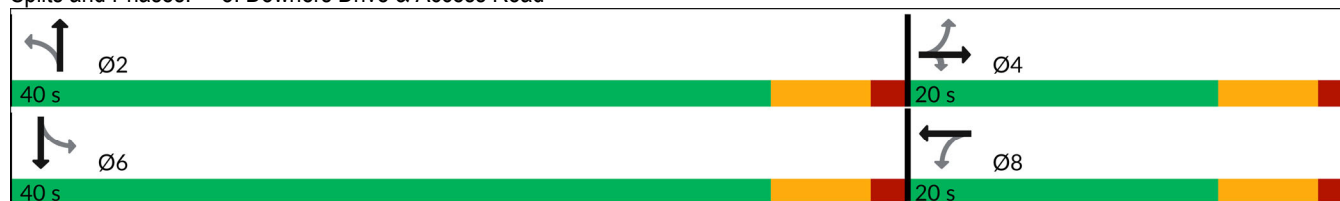

HCM 7th TWSC

7: Butterfield Road & Right-I/Right-Out Access Drive

11/19/2025

Intersection						
Int Delay, s/veh	0.4					
Movement	EBL	EBT	WBT	WBR	SBL	SBR
Lane Configurations		↑↑	↑↑↑			↑
Traffic Vol, veh/h	0	1477	2090	125	0	51
Future Vol, veh/h	0	1477	2090	125	0	51
Conflicting Peds, #/hr	0	0	0	0	0	0
Sign Control	Free	Free	Free	Free	Stop	Stop
RT Channelized	-	None	-	Free	-	Stop
Storage Length	-	-	-	-	-	0
Veh in Median Storage, #	-	0	0	-	0	-
Grade, %	-	0	0	-	0	-
Peak Hour Factor	99	99	99	99	99	99
Heavy Vehicles, %	0	1	1	1	0	0
Mvmt Flow	0	1492	2111	126	0	52

Major/Minor	Major1	Major2	Minor2
Conflicting Flow All	-	0	- 0 - 1056
Stage 1	-	-	- - -
Stage 2	-	-	- - -
Critical Hdwy	-	-	- - 7.1
Critical Hdwy Stg 1	-	-	- - -
Critical Hdwy Stg 2	-	-	- - -
Follow-up Hdwy	-	-	- - 3.9
Pot Cap-1 Maneuver	0	-	- 0 0 193
Stage 1	0	-	- 0 0 -
Stage 2	0	-	- 0 0 -
Platoon blocked, %	-	-	
Mov Cap-1 Maneuver	-	-	- - 193
Mov Cap-2 Maneuver	-	-	- - -
Stage 1	-	-	- - -
Stage 2	-	-	- - -

Approach	EB	WB	SB
HCM Ctrl Dly, s/v	0	0	30.27
HCM LOS			D

Minor Lane/Major Mvmt	EBT	WBT	SBLn1
Capacity (veh/h)	-	-	193
HCM Lane V/C Ratio	-	-	0.267
HCM Ctrl Dly (s/v)	-	-	30.3
HCM Lane LOS	-	-	D
HCM 95th %tile Q(veh)	-	-	1

Capacity Analysis Summary Sheets
Year 2031 No-Build Weekday Morning Peak Hour

Intersection Capacity Utilization 12: Access Drive & Access Road

11/20/2025



Movement	EBL	EBT	EBR	WBL	WBT	WBR	NBL	NBT	NBR	SBL	SBT	SBR
Lane Configurations		↕			↕			↕			↕	
Volume (vph)	0	28	32	0	27	0	33	0	0	0	0	1
Pedestrians												
Ped Button												
Pedestrian Timing (s)												
Free Right	No			No			No			No		
Ideal Flow	1900	1900	1900	1900	1900	1900	1900	1900	1900	1900	1900	1900
Lost Time (s)	4.0	4.0	4.0	4.0	4.0	4.0	4.0	4.0	4.0	4.0	4.0	4.0
Minimum Green (s)	4.0	4.0	4.0	4.0	4.0	4.0	4.0	4.0	4.0	4.0	4.0	4.0
Refr Cycle Length (s)	120	120	120	120	120	120	120	120	120	120	120	120
Volume Combined (vph)	0	60	0	0	27	0	0	33	0	0	0	1
Lane Utilization Factor	1.00	1.00	1.00	1.00	1.00	1.00	1.00	1.00	1.00	1.00	1.00	1.00
Turning Factor (vph)	0.95	0.92	0.85	0.95	1.00	0.85	0.95	0.95	0.85	0.95	0.85	0.85
Saturated Flow (vph)	0	1748	0	0	1900	0	0	1805	0	0	1615	0
Ped Intf Time (s)	0.0	0.0	0.0	0.0	0.0	0.0	0.0	0.0	0.0	0.0	0.0	0.0
Pedestrian Frequency (%)	0.00		0.00		0.00		0.00		0.00		0.00	
Protected Option Allowed	No		No		No		No		No		No	
Reference Time (s)	0.0		0.0		0.0		0.0		0.0		0.0	
Adj Reference Time (s)	0.0		0.0		0.0		0.0		0.0		0.0	
Permitted Option												
Adj Saturation A (vph)	0	1748	0	1900	0	120	0	1615	0	1615	0	1615
Reference Time A (s)	0.0	4.1	0.0	1.7	0.0	32.9	0.0	0.1	0.0	0.1	0.0	0.1
Adj Saturation B (vph)	0	1748	0	1900	0	0	0	1615	0	1615	0	1615
Reference Time B (s)	0.0	4.1	0.0	1.7	10.2	10.2	0.0	0.1	0.0	0.1	0.0	0.1
Reference Time (s)	4.1		1.7		10.2		0.1		0.1		0.1	
Adj Reference Time (s)	8.1		8.0		14.2		8.0		8.0		8.0	
Split Option												
Ref Time Combined (s)	0.0	4.1	0.0	1.7	0.0	2.2	0.0	0.1	0.0	0.1	0.0	0.1
Ref Time Seperate (s)	0.0	1.9	0.0	1.7	2.2	0.0	0.0	0.0	0.0	0.0	0.0	0.0
Reference Time (s)	4.1	4.1	1.7	1.7	2.2	2.2	0.1	0.1	0.1	0.1	0.1	0.1
Adj Reference Time (s)	8.1	8.1	8.0	8.0	8.0	8.0	8.0	8.0	8.0	8.0	8.0	8.0
Summary	EB WB	NB SB	Combined									
Protected Option (s)	NA	NA										
Permitted Option (s)	8.1	14.2										
Split Option (s)	16.1	16.0										
Minimum (s)	8.1	14.2	22.3									
Right Turns												
Adj Reference Time (s)												
Cross Thru Ref Time (s)												
Oncoming Left Ref Time (s)												
Combined (s)												
Intersection Summary												
Intersection Capacity Utilization	18.6%		ICU Level of Service		A							
Reference Times and Phasing Options do not represent an optimized timing plan.												

Lanes and Geometrics

3: Downers Drive & Butterfield Road

11/20/2025

Lane Group	EBL	EBT	EBR	WBL	WBT	WBR	NBL	NBT	NBR	SBL	SBT	SBR
Lane Configurations												
Traffic Volume (vph)	97	1683	160	378	1311	201	19	16	35	115	38	37
Future Volume (vph)	97	1683	160	378	1311	201	19	16	35	115	38	37
Ideal Flow (vphp)	1900	2000	1900	1900	2000	1900	1900	1900	1900	1900	1900	1900
Storage Length (ft)	230		280	350		335	0		0	0		150
Storage Lanes	2		1	2		1	1		0	1		1
Taper Length (ft)	300			300			25			0		
Lane Util. Factor	0.97	0.91	1.00	0.97	0.91	1.00	1.00	1.00	1.00	1.00	1.00	1.00
Frt			0.850			0.850		0.897				0.850
Flt Protected	0.950			0.950			0.950			0.950		
Satd. Flow (prot)	3400	5353	1599	3467	5301	1583	1805	1630	0	1736	1845	1482
Flt Permitted	0.950			0.950			0.731			0.508		
Satd. Flow (perm)	3400	5353	1599	3467	5301	1583	1389	1630	0	928	1845	1482
Right Turn on Red			Yes			Yes			Yes			Yes
Satd. Flow (RTOR)			168			212		37				96
Link Speed (mph)		45			45			25				25
Link Distance (ft)		967			826			734				471
Travel Time (s)		14.7			12.5			20.0				12.8
Peak Hour Factor	0.95	0.95	0.95	0.95	0.95	0.95	0.95	0.95	0.95	0.95	0.95	0.95
Heavy Vehicles (%)	3%	2%	1%	1%	3%	2%	0%	8%	3%	4%	3%	9%
Shared Lane Traffic (%)												
Lane Group Flow (vph)	102	1772	168	398	1380	212	20	54	0	121	40	39
Turn Type	Prot	NA	Perm	Prot	NA	Perm	pm+pt	NA		pm+pt	NA	pm+ov
Protected Phases	5	2		1	6		3	8		7	4	5
Permitted Phases			2			6	8			4		4
Detector Phase	5	2	2	1	6	6	3	8		7	4	5
Switch Phase												
Minimum Initial (s)	3.0	15.0	15.0	3.0	15.0	15.0	3.0	8.0		3.0	8.0	3.0
Minimum Split (s)	7.5	21.0	21.0	7.5	21.0	21.0	6.5	14.0		6.5	14.0	7.5
Total Split (s)	13.0	68.0	68.0	24.0	79.0	79.0	12.0	21.0		12.0	21.0	13.0
Total Split (%)	10.4%	54.4%	54.4%	19.2%	63.2%	63.2%	9.6%	16.8%		9.6%	16.8%	10.4%
Yellow Time (s)	3.5	4.5	4.5	3.5	4.5	4.5	3.5	4.5		3.5	4.5	3.5
All-Red Time (s)	1.0	1.5	1.5	1.0	1.5	1.5	0.0	1.5		0.0	1.5	1.0
Lost Time Adjust (s)	0.0	0.0	0.0	0.0	0.0	0.0	0.0	0.0		0.0	0.0	0.0
Total Lost Time (s)	4.5	6.0	6.0	4.5	6.0	6.0	3.5	6.0		3.5	6.0	4.5
Lead/Lag	Lead	Lag	Lag	Lead	Lag	Lag	Lead	Lag		Lead	Lag	Lead
Lead-Lag Optimize?	Yes	Yes	Yes	Yes	Yes	Yes	Yes	Yes		Yes	Yes	Yes
Recall Mode	None	C-Min	C-Min	None	C-Min	C-Min	None	None		None	None	None
Act Effct Green (s)	9.1	70.7	70.7	19.2	80.8	80.8	16.1	9.0		20.0	14.1	29.2
Actuated g/C Ratio	0.07	0.57	0.57	0.15	0.65	0.65	0.13	0.07		0.16	0.11	0.23
v/c Ratio	0.41	0.59	0.17	0.75	0.40	0.19	0.10	0.36		0.59	0.19	0.09
Control Delay (s/veh)	60.0	19.8	2.8	59.7	11.8	1.9	42.2	31.1		57.7	53.1	0.4
Queue Delay	0.0	0.0	0.0	0.0	0.0	0.0	0.0	0.0		0.0	0.0	0.0
Total Delay (s/veh)	60.0	19.8	2.8	59.7	11.8	1.9	42.2	31.1		57.7	53.1	0.4
LOS	E	B	A	E	B	A	D	C		E	D	A
Approach Delay (s/veh)		20.4			20.3			34.1				45.6
Approach LOS		C			C			C				D
Queue Length 50th (ft)	42	342	0	161	192	0	14	14		90	29	0
Queue Length 95th (ft)	71	444	36	211	258	33	35	58		147	69	0

Lanes and Geometrics

3: Downers Drive & Butterfield Road

11/20/2025



Lane Group	EBL	EBT	EBR	WBL	WBT	WBR	NBL	NBT	NBR	SBL	SBT	SBR
Internal Link Dist (ft)		887			746			654			391	
Turn Bay Length (ft)	230		280	350		335						150
Base Capacity (vph)	260	3028	977	568	3425	1097	227	228		205	251	424
Starvation Cap Reductn	0	0	0	0	0	0	0	0		0	0	0
Spillback Cap Reductn	0	0	0	0	0	0	0	0		0	0	0
Storage Cap Reductn	0	0	0	0	0	0	0	0		0	0	0
Reduced v/c Ratio	0.39	0.59	0.17	0.70	0.40	0.19	0.09	0.24		0.59	0.16	0.09

Intersection Summary

Area Type:	Other
Cycle Length:	125
Actuated Cycle Length:	125
Offset:	0 (0%), Referenced to phase 2:EBT and 6:WBT, Start of Green
Natural Cycle:	65
Control Type:	Actuated-Coordinated
Maximum v/c Ratio:	0.75
Intersection Signal Delay (s/veh):	21.8
Intersection LOS:	C
Intersection Capacity Utilization:	68.5%
ICU Level of Service:	C
Analysis Period (min):	15

Splits and Phases: 3: Downers Drive & Butterfield Road



Lanes and Geometrics

8: Downers Drive & Access Road

11/20/2025



Lane Group	EBL	EBT	EBR	WBL	WBT	WBR	NBL	NBT	NBR	SBL	SBT	SBR
Lane Configurations		↕	↗	↖	↗			↕			↕	
Traffic Volume (vph)	11	10	123	50	8	4	191	71	52	4	16	3
Future Volume (vph)	11	10	123	50	8	4	191	71	52	4	16	3
Ideal Flow (vphp)	1900	1900	1900	1900	1900	1900	1900	1900	1900	1900	1900	1900
Storage Length (ft)	0		40	0		0	0		0	0		0
Storage Lanes	0		1	1		0	0		0	0		0
Taper Length (ft)	25			25			25			25		
Lane Util. Factor	1.00	1.00	1.00	1.00	1.00	1.00	0.95	0.95	0.95	0.95	0.95	0.95
Frt			0.850		0.954			0.975			0.982	
Flt Protected		0.975		0.950				0.970			0.992	
Satd. Flow (prot)	0	1852	1599	1805	1813	0	0	3307	0	0	2842	0
Flt Permitted		0.829		0.742				0.782			0.909	
Satd. Flow (perm)	0	1575	1599	1410	1813	0	0	2666	0	0	2604	0
Right Turn on Red			Yes			Yes			Yes			Yes
Satd. Flow (RTOR)			135		4			57			3	
Link Speed (mph)		20			20			25			25	
Link Distance (ft)		252			487			471			398	
Travel Time (s)		8.6			16.6			12.8			10.9	
Peak Hour Factor	0.91	0.91	0.91	0.91	0.91	0.91	0.91	0.91	0.91	0.91	0.91	0.91
Heavy Vehicles (%)	0%	0%	1%	0%	0%	0%	2%	9%	0%	0%	33%	0%
Shared Lane Traffic (%)												
Lane Group Flow (vph)	0	23	135	55	13	0	0	345	0	0	25	0
Turn Type	Perm	NA	Perm	Perm	NA		Perm	NA		Perm	NA	
Protected Phases		4			8			2			6	
Permitted Phases	4		4	8			2			6		
Detector Phase	4	4	4	8	8		2	2		6	6	
Switch Phase												
Minimum Initial (s)	8.0	8.0	8.0	8.0	8.0		15.0	15.0		15.0	15.0	
Minimum Split (s)	14.0	14.0	14.0	14.0	14.0		24.0	24.0		24.0	24.0	
Total Split (s)	14.0	14.0	14.0	14.0	14.0		66.0	66.0		66.0	66.0	
Total Split (%)	17.5%	17.5%	17.5%	17.5%	17.5%		82.5%	82.5%		82.5%	82.5%	
Yellow Time (s)	4.5	4.5	4.5	4.5	4.5		4.5	4.5		4.5	4.5	
All-Red Time (s)	1.5	1.5	1.5	1.5	1.5		1.5	1.5		1.5	1.5	
Lost Time Adjust (s)		0.0	0.0	0.0	0.0			0.0			0.0	
Total Lost Time (s)		6.0	6.0	6.0	6.0			6.0			6.0	
Lead/Lag												
Lead-Lag Optimize?												
Recall Mode	None	None	None	None	None		Min	Min		Min	Min	
Act Effct Green (s)		8.1	8.1	8.1	8.1			22.2			22.2	
Actuated g/C Ratio		0.21	0.21	0.21	0.21			0.58			0.58	
v/c Ratio		0.07	0.30	0.18	0.03			0.22			0.02	
Control Delay (s/veh)		14.4	6.1	15.6	12.4			5.0			4.7	
Queue Delay		0.0	0.0	0.0	0.0			0.0			0.0	
Total Delay (s/veh)		14.4	6.1	15.6	12.4			5.0			4.7	
LOS		B	A	B	B			A			A	
Approach Delay (s/veh)		7.3			15.0			5.0			4.7	
Approach LOS		A			B			A			A	
Queue Length 50th (ft)		4	0	9	1			17			1	
Queue Length 95th (ft)		19	33	35	12			34			5	

Lanes and Geometrics

8: Downers Drive & Access Road

11/20/2025



Lane Group	EBL	EBT	EBR	WBL	WBT	WBR	NBL	NBT	NBR	SBL	SBT	SBR
Internal Link Dist (ft)		172			407			391			318	
Turn Bay Length (ft)			40									
Base Capacity (vph)		333	444	298	386			2666			2604	
Starvation Cap Reductn		0	0	0	0			0			0	
Spillback Cap Reductn		0	0	0	0			0			0	
Storage Cap Reductn		0	0	0	0			0			0	
Reduced v/c Ratio		0.07	0.30	0.18	0.03			0.13			0.01	

Intersection Summary

Area Type:	Other
Cycle Length:	80
Actuated Cycle Length:	38.1
Natural Cycle:	40
Control Type:	Actuated-Uncoordinated
Maximum v/c Ratio:	0.30
Intersection Signal Delay (s/veh):	6.8
Intersection LOS:	A
Intersection Capacity Utilization:	41.8%
ICU Level of Service:	A
Analysis Period (min):	15

Splits and Phases: 8: Downers Drive & Access Road

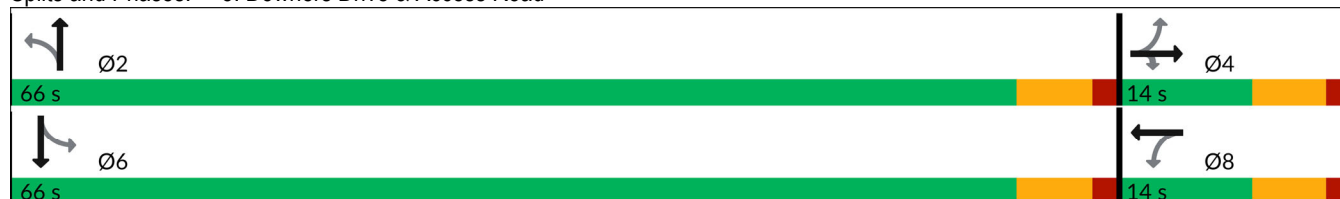

HCM 7th TWSC

7: Butterfield Road & Right-I/Right-Out Access Drive

11/20/2025

Intersection						
Int Delay, s/veh	0.2					
Movement	EBL	EBT	WBT	WBR	SBL	SBR
Lane Configurations		↑↑	↑↑↑			↑
Traffic Vol, veh/h	0	1833	1863	45	0	27
Future Vol, veh/h	0	1833	1863	45	0	27
Conflicting Peds, #/hr	0	0	0	0	0	0
Sign Control	Free	Free	Free	Free	Stop	Stop
RT Channelized	-	None	-	Free	-	Stop
Storage Length	-	-	-	-	-	0
Veh in Median Storage, #	-	0	0	-	0	-
Grade, %	-	0	0	-	0	-
Peak Hour Factor	95	95	95	95	95	95
Heavy Vehicles, %	0	2	2	0	0	14
Mvmt Flow	0	1929	1961	47	0	28

Major/Minor	Major1	Major2	Minor2
Conflicting Flow All	-	0	- 0 - 981
Stage 1	-	-	- - -
Stage 2	-	-	- - -
Critical Hdwy	-	-	- - 7.38
Critical Hdwy Stg 1	-	-	- - -
Critical Hdwy Stg 2	-	-	- - -
Follow-up Hdwy	-	-	- - 4.04
Pot Cap-1 Maneuver	0	-	- 0 0 197
Stage 1	0	-	- 0 0 -
Stage 2	0	-	- 0 0 -
Platoon blocked, %	-	-	
Mov Cap-1 Maneuver	-	-	- - 197
Mov Cap-2 Maneuver	-	-	- - -
Stage 1	-	-	- - -
Stage 2	-	-	- - -

Approach	EB	WB	SB
HCM Ctrl Dly, s/v	0	0	26.35
HCM LOS			D

Minor Lane/Major Mvmt	EBT	WBT	SBLn1
Capacity (veh/h)	-	-	197
HCM Lane V/C Ratio	-	-	0.144
HCM Ctrl Dly (s/v)	-	-	26.3
HCM Lane LOS	-	-	D
HCM 95th %tile Q(veh)	-	-	0.5

Capacity Analysis Summary Sheets
Year 2031 No-Build Weekday Evening Peak Hour

Intersection Capacity Utilization 12: Access Drive & Access Road

11/20/2025



Movement	EBL	EBT	EBR	WBL	WBT	WBR	NBL	NBT	NBR	SBL	SBT	SBR
Lane Configurations		↕			↕			↕			↕	
Volume (vph)	3	73	28	10	154	0	26	0	4	0	0	1
Pedestrians												
Ped Button												
Pedestrian Timing (s)												
Free Right	No			No			No			No		
Ideal Flow	1900	1900	1900	1900	1900	1900	1900	1900	1900	1900	1900	1900
Lost Time (s)	4.0	4.0	4.0	4.0	4.0	4.0	4.0	4.0	4.0	4.0	4.0	4.0
Minimum Green (s)	4.0	4.0	4.0	4.0	4.0	4.0	4.0	4.0	4.0	4.0	4.0	4.0
Refr Cycle Length (s)	120	120	120	120	120	120	120	120	120	120	120	120
Volume Combined (vph)	0	104	0	0	164	0	0	30	0	0	1	0
Lane Utilization Factor	1.00	1.00	1.00	1.00	1.00	1.00	1.00	1.00	1.00	1.00	1.00	1.00
Turning Factor (vph)	0.95	0.96	0.85	0.95	1.00	0.85	0.95	0.94	0.85	0.95	0.85	0.85
Saturated Flow (vph)	0	1821	0	0	1894	0	0	1781	0	0	1615	0
Ped Intf Time (s)	0.0	0.0	0.0	0.0	0.0	0.0	0.0	0.0	0.0	0.0	0.0	0.0
Pedestrian Frequency (%)	0.00		0.00			0.00			0.00		0.00	
Protected Option Allowed	No		No			No			No		No	
Reference Time (s)			0.0			0.0			0.0		0.0	
Adj Reference Time (s)			0.0			0.0			0.0		0.0	
Permitted Option												
Adj Saturation A (vph)	0	1612	0		1298	0		131	0		1615	
Reference Time A (s)	0.0	7.7	0.0		15.2	0.0		27.5	0.0		0.1	
Adj Saturation B (vph)	NA	NA	0		0	0		0	0		1615	
Reference Time B (s)	NA	NA	8.7		18.4	9.7		10.0	0.0		0.1	
Reference Time (s)	7.7		15.2			10.0			0.1			
Adj Reference Time (s)	11.7		19.2			14.0			8.0			
Split Option												
Ref Time Combined (s)	0.0	6.9	0.0		10.4	0.0		2.0	0.0		0.1	
Ref Time Seperate (s)	0.2	4.8	0.7		9.7	1.7		0.0	0.0		0.0	
Reference Time (s)	6.9	6.9	10.4		10.4	2.0		2.0	0.1		0.1	
Adj Reference Time (s)	10.9	10.9	14.4		14.4	8.0		8.0	8.0		8.0	
Summary	EB WB		NB SB		Combined							
Protected Option (s)	NA		NA									
Permitted Option (s)	19.2		14.0									
Split Option (s)	25.2		16.0									
Minimum (s)	19.2		14.0		33.2							
Right Turns												
Adj Reference Time (s)												
Cross Thru Ref Time (s)												
Oncoming Left Ref Time (s)												
Combined (s)												
Intersection Summary												
Intersection Capacity Utilization	27.7%		ICU Level of Service		A							
Reference Times and Phasing Options do not represent an optimized timing plan.												

Lanes and Geometrics

3: Downers Drive & Butterfield Road

11/20/2025

Lane Group	EBL	EBT	EBR	WBL	WBT	WBR	NBL	NBT	NBR	SBL	SBT	SBR
Lane Configurations												
Traffic Volume (vph)	112	1544	104	789	1897	233	100	32	119	300	69	126
Future Volume (vph)	112	1544	104	789	1897	233	100	32	119	300	69	126
Ideal Flow (vphpl)	1900	2000	1900	1900	2000	1900	1900	1900	1900	1900	1900	1900
Storage Length (ft)	230		280	350		335	0		0	0		150
Storage Lanes	2		1	2		1	1		0	1		1
Taper Length (ft)	300			300			25			0		
Lane Util. Factor	0.97	0.91	1.00	0.97	0.91	1.00	1.00	1.00	1.00	1.00	1.00	1.00
Frt			0.850			0.850		0.882				0.850
Flt Protected	0.950			0.950			0.950			0.950		
Satd. Flow (prot)	3400	5353	1599	3467	5406	1615	1805	1676	0	1787	1845	1599
Flt Permitted	0.950			0.950			0.710			0.270		
Satd. Flow (perm)	3400	5353	1599	3467	5406	1615	1349	1676	0	508	1845	1599
Right Turn on Red			Yes			Yes			Yes			Yes
Satd. Flow (RTOR)			154			243		111				89
Link Speed (mph)		45			45			25				25
Link Distance (ft)		967			826			734				471
Travel Time (s)		14.7			12.5			20.0				12.8
Peak Hour Factor	0.96	0.96	0.96	0.96	0.96	0.96	0.96	0.96	0.96	0.96	0.96	0.96
Heavy Vehicles (%)	3%	2%	1%	1%	1%	0%	0%	0%	0%	1%	3%	1%
Shared Lane Traffic (%)												
Lane Group Flow (vph)	117	1608	108	822	1976	243	104	157	0	313	72	131
Turn Type	Prot	NA	Perm	Prot	NA	Perm	pm+pt	NA		pm+pt	NA	pm+ov
Protected Phases	5	2		1	6		3	8		7	4	5
Permitted Phases			2			6	8			4		4
Detector Phase	5	2	2	1	6	6	3	8		7	4	5
Switch Phase												
Minimum Initial (s)	3.0	15.0	15.0	3.0	15.0	15.0	3.0	8.0		3.0	8.0	3.0
Minimum Split (s)	7.5	21.0	21.0	7.5	21.0	21.0	6.5	14.0		6.5	14.0	7.5
Total Split (s)	13.0	49.0	49.0	44.0	80.0	80.0	14.0	19.0		23.0	28.0	13.0
Total Split (%)	9.6%	36.3%	36.3%	32.6%	59.3%	59.3%	10.4%	14.1%		17.0%	20.7%	9.6%
Yellow Time (s)	3.5	4.5	4.5	3.5	4.5	4.5	3.5	4.5		3.5	4.5	3.5
All-Red Time (s)	1.0	1.5	1.5	1.0	1.5	1.5	0.0	1.5		0.0	1.5	1.0
Lost Time Adjust (s)	0.0	0.0	0.0	0.0	0.0	0.0	0.0	0.0		0.0	0.0	0.0
Total Lost Time (s)	4.5	6.0	6.0	4.5	6.0	6.0	3.5	6.0		3.5	6.0	4.5
Lead/Lag	Lead	Lag	Lag	Lead	Lag	Lag	Lead	Lag		Lead	Lag	Lead
Lead-Lag Optimize?	Yes	Yes	Yes	Yes	Yes	Yes	Yes	Yes		Yes	Yes	Yes
Recall Mode	None	C-Min	C-Min	None	C-Min	C-Min	None	None		None	None	None
Act Effct Green (s)	8.8	48.9	48.9	36.5	76.6	76.6	25.5	10.1		32.8	17.4	29.4
Actuated g/C Ratio	0.07	0.36	0.36	0.27	0.57	0.57	0.19	0.07		0.24	0.13	0.22
v/c Ratio	0.53	0.83	0.16	0.88	0.64	0.24	0.34	0.69		1.02	0.30	0.31
Control Delay (s/veh)	70.1	44.5	1.9	58.4	21.4	2.3	42.2	36.2		102.0	55.0	16.3
Queue Delay	0.0	0.0	0.0	0.0	0.0	0.0	0.0	0.0		0.0	0.0	0.0
Total Delay (s/veh)	70.1	44.5	1.9	58.4	21.4	2.3	42.2	36.2		102.0	55.0	16.3
LOS	E	D	A	E	C	A	D	D		F	D	B
Approach Delay (s/veh)		43.6			29.9			38.6				73.7
Approach LOS		D			C			D				E
Queue Length 50th (ft)	53	478	0	355	421	0	72	39		250	59	29
Queue Length 95th (ft)	88	#610	13	428	491	39	120	113		#395	106	82

Lanes and Geometrics

3: Downers Drive & Butterfield Road

11/20/2025

Lane Group	EBL	EBT	EBR	WBL	WBT	WBR	NBL	NBT	NBR	SBL	SBT	SBR
Internal Link Dist (ft)		887			746			654			391	
Turn Bay Length (ft)	230		280	350		335				308	300	150
Base Capacity (vph)	227	1939	677	1018	3068	1021	306	261		308	300	420
Starvation Cap Reductn	0	0	0	0	0	0	0	0		0	0	0
Spillback Cap Reductn	0	0	0	0	0	0	0	0		0	0	0
Storage Cap Reductn	0	0	0	0	0	0	0	0		0	0	0
Reduced v/c Ratio	0.52	0.83	0.16	0.81	0.64	0.24	0.34	0.60		1.02	0.24	0.31

Intersection Summary

Area Type: Other
 Cycle Length: 135
 Actuated Cycle Length: 135
 Offset: 63 (47%), Referenced to phase 2:EBT and 6:WBT, Start of Green
 Natural Cycle: 90
 Control Type: Actuated-Coordinated
 Maximum v/c Ratio: 1.02
 Intersection Signal Delay (s/veh): 38.7 Intersection LOS: D
 Intersection Capacity Utilization 93.6% ICU Level of Service F
 Analysis Period (min) 15
 # 95th percentile volume exceeds capacity, queue may be longer.
 Queue shown is maximum after two cycles.

Splits and Phases: 3: Downers Drive & Butterfield Road

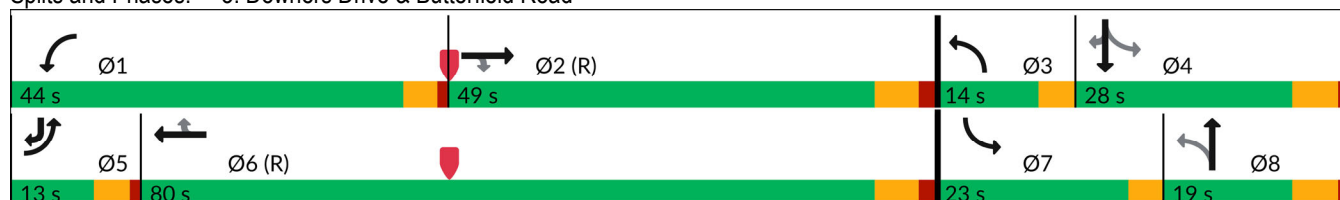

Lanes and Geometrics

8: Downers Drive & Access Road

11/20/2025



Lane Group	EBL	EBT	EBR	WBL	WBT	WBR	NBL	NBT	NBR	SBL	SBT	SBR
Lane Configurations		↕	↗	↖	↘			↕			↕	
Traffic Volume (vph)	3	56	247	165	46	14	254	25	99	10	83	7
Future Volume (vph)	3	56	247	165	46	14	254	25	99	10	83	7
Ideal Flow (vphp)	1900	1900	1900	1900	1900	1900	1900	1900	1900	1900	1900	1900
Storage Length (ft)	0		40	0		0	0		0	0		0
Storage Lanes	0		1	1		0	0		0	0		0
Taper Length (ft)	25			25			25			25		
Lane Util. Factor	1.00	1.00	1.00	1.00	1.00	1.00	0.95	0.95	0.95	0.95	0.95	0.95
Frt			0.850		0.965			0.961			0.989	
Flt Protected		0.998		0.950				0.968			0.995	
Satd. Flow (prot)	0	1896	1615	1787	1834	0	0	3332	0	0	3385	0
Flt Permitted		0.986		0.715				0.731			0.909	
Satd. Flow (perm)	0	1873	1615	1345	1834	0	0	2516	0	0	3092	0
Right Turn on Red			Yes			Yes			Yes			Yes
Satd. Flow (RTOR)			268		15			108			8	
Link Speed (mph)		20			20			25			25	
Link Distance (ft)		252			487			471			398	
Travel Time (s)		8.6			16.6			12.8			10.9	
Peak Hour Factor	0.92	0.92	0.92	0.92	0.92	0.92	0.92	0.92	0.92	0.92	0.92	0.92
Heavy Vehicles (%)	0%	0%	0%	1%	0%	0%	0%	8%	1%	0%	6%	0%
Shared Lane Traffic (%)												
Lane Group Flow (vph)	0	64	268	179	65	0	0	411	0	0	109	0
Turn Type	Perm	NA	Perm	Perm	NA		Perm	NA		Perm	NA	
Protected Phases		4			8			2			6	
Permitted Phases	4		4	8			2			6		
Detector Phase	4	4	4	8	8		2	2		6	6	
Switch Phase												
Minimum Initial (s)	8.0	8.0	8.0	8.0	8.0		8.0	8.0		8.0	8.0	
Minimum Split (s)	14.0	14.0	14.0	14.0	14.0		14.0	14.0		14.0	14.0	
Total Split (s)	20.0	20.0	20.0	20.0	20.0		40.0	40.0		40.0	40.0	
Total Split (%)	33.3%	33.3%	33.3%	33.3%	33.3%		66.7%	66.7%		66.7%	66.7%	
Yellow Time (s)	4.5	4.5	4.5	4.5	4.5		4.5	4.5		4.5	4.5	
All-Red Time (s)	1.5	1.5	1.5	1.5	1.5		1.5	1.5		1.5	1.5	
Lost Time Adjust (s)		0.0	0.0	0.0	0.0			0.0			0.0	
Total Lost Time (s)		6.0	6.0	6.0	6.0			6.0			6.0	
Lead/Lag												
Lead-Lag Optimize?												
Recall Mode	None	None	None	None	None		Min	Min		Min	Min	
Act Effct Green (s)		11.5	11.5	11.5	11.5			20.6			20.6	
Actuated g/C Ratio		0.26	0.26	0.26	0.26			0.46			0.46	
v/c Ratio		0.13	0.44	0.52	0.13			0.34			0.08	
Control Delay (s/veh)		15.8	5.5	22.4	13.3			6.1			6.3	
Queue Delay		0.0	0.0	0.0	0.0			0.0			0.0	
Total Delay (s/veh)		15.8	5.5	22.4	13.3			6.1			6.3	
LOS		B	A	C	B			A			A	
Approach Delay (s/veh)		7.5			20.0			6.1			6.3	
Approach LOS		A			B			A			A	
Queue Length 50th (ft)		12	0	37	9			23			7	
Queue Length 95th (ft)		44	49	113	40			47			17	

Lanes and Geometrics

8: Downers Drive & Access Road

11/20/2025

Lane Group	EBL	EBT	EBR	WBL	WBT	WBR	NBL	NBT	NBR	SBL	SBT	SBR
Internal Link Dist (ft)		172			407			391			318	
Turn Bay Length (ft)			40									
Base Capacity (vph)		613	709	440	610			2007			2440	
Starvation Cap Reductn		0	0	0	0			0			0	
Spillback Cap Reductn		0	0	0	0			0			0	
Storage Cap Reductn		0	0	0	0			0			0	
Reduced v/c Ratio		0.10	0.38	0.41	0.11			0.20			0.04	

Intersection Summary

Area Type:	Other
Cycle Length:	60
Actuated Cycle Length:	44.6
Natural Cycle:	40
Control Type:	Actuated-Uncoordinated
Maximum v/c Ratio:	0.52
Intersection Signal Delay (s/veh):	9.6
Intersection LOS:	A
Intersection Capacity Utilization:	46.5%
ICU Level of Service:	A
Analysis Period (min):	15

Splits and Phases: 8: Downers Drive & Access Road

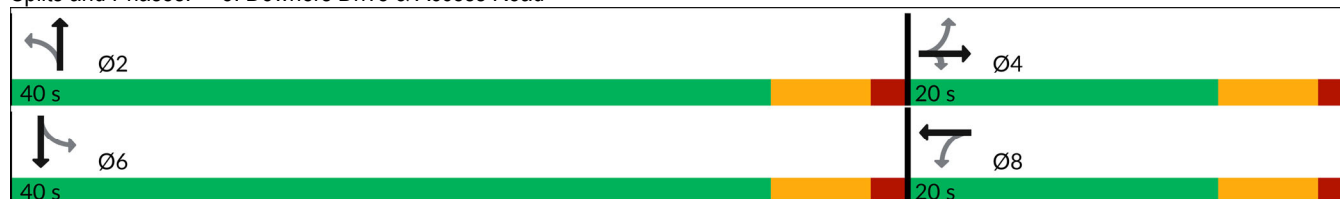

HCM 7th TWSC

7: Butterfield Road & Right-I/Right-Out Access Drive

11/20/2025

Intersection						
Int Delay, s/veh	0.9					
Movement	EBL	EBT	WBT	WBR	SBL	SBR
Lane Configurations		↑↑	↑↑↑			↑
Traffic Vol, veh/h	0	1963	2869	124	0	51
Future Vol, veh/h	0	1963	2869	124	0	51
Conflicting Peds, #/hr	0	0	0	0	0	0
Sign Control	Free	Free	Free	Free	Stop	Stop
RT Channelized	-	None	-	Free	-	Stop
Storage Length	-	-	-	-	-	0
Veh in Median Storage, #	-	0	0	-	0	-
Grade, %	-	0	0	-	0	-
Peak Hour Factor	95	95	95	95	95	95
Heavy Vehicles, %	0	1	1	0	0	0
Mvmt Flow	0	2066	3020	131	0	54

Major/Minor	Major1	Major2	Minor2
Conflicting Flow All	-	0	- 0 - 1510
Stage 1	-	-	- - -
Stage 2	-	-	- - -
Critical Hdwy	-	-	- - 7.1
Critical Hdwy Stg 1	-	-	- - -
Critical Hdwy Stg 2	-	-	- - -
Follow-up Hdwy	-	-	- - 3.9
Pot Cap-1 Maneuver	0	-	- 0 0 95
Stage 1	0	-	- 0 0 -
Stage 2	0	-	- 0 0 -
Platoon blocked, %	-	-	
Mov Cap-1 Maneuver	-	-	- - 95
Mov Cap-2 Maneuver	-	-	- - -
Stage 1	-	-	- - -
Stage 2	-	-	- - -

















Approach	EB	WB	SB
HCM Ctrl Dly, s/v	0	0	82.99
HCM LOS			F

Minor Lane/Major Mvmt	EBT	WBT	SBLn1
Capacity (veh/h)	-	-	95
HCM Lane V/C Ratio	-	-	0.563
HCM Ctrl Dly (s/v)	-	-	83
HCM Lane LOS	-	-	F
HCM 95th %tile Q(veh)	-	-	2.6

Capacity Analysis Summary Sheets
Year 2031 No-Build Saturday Midday Peak Hour

Intersection Capacity Utilization 12: Access Drive & Access Road

11/20/2025

												
Movement	EBL	EBT	EBR	WBL	WBT	WBR	NBL	NBT	NBR	SBL	SBT	SBR
Lane Configurations												
Volume (vph)	2	140	48	12	200	1	65	0	5	2	0	0
Pedestrians												
Ped Button												
Pedestrian Timing (s)												
Free Right			No			No			No			No
Ideal Flow	1900	1900	1900	1900	1900	1900	1900	1900	1900	1900	1900	1900
Lost Time (s)	4.0	4.0	4.0	4.0	4.0	4.0	4.0	4.0	4.0	4.0	4.0	4.0
Minimum Green (s)	4.0	4.0	4.0	4.0	4.0	4.0	4.0	4.0	4.0	4.0	4.0	4.0
Refr Cycle Length (s)	120	120	120	120	120	120	120	120	120	120	120	120
Volume Combined (vph)	0	190	0	0	213	0	0	70	0	0	2	0
Lane Utilization Factor	1.00	1.00	1.00	1.00	1.00	1.00	1.00	1.00	1.00	1.00	1.00	1.00
Turning Factor (vph)	0.95	0.96	0.85	0.95	1.00	0.85	0.95	0.94	0.85	0.95	0.95	0.85
Saturated Flow (vph)	0	1827	0	0	1893	0	0	1792	0	0	1805	0
Ped Intf Time (s)	0.0	0.0	0.0	0.0	0.0	0.0	0.0	0.0	0.0	0.0	0.0	0.0
Pedestrian Frequency (%)		0.00			0.00			0.00			0.00	
Protected Option Allowed		No			No			No			No	
Reference Time (s)			0.0			0.0			0.0			0.0
Adj Reference Time (s)			0.0			0.0			0.0			0.0
Permitted Option												
Adj Saturation A (vph)	0	1742		0	1173		0	1927		0	1796	
Reference Time A (s)	0.0	13.1		0.0	21.8		0.0	4.4		0.0	0.1	
Adj Saturation B (vph)	NA	NA		NA	NA		0	0		0	0	
Reference Time B (s)	NA	NA		NA	NA		12.3	12.7		8.1	8.1	
Reference Time (s)		13.1			21.8			4.4			0.1	
Adj Reference Time (s)		17.1			25.8			8.4			8.0	
Split Option												
Ref Time Combined (s)	0.0	12.5		0.0	13.5		0.0	4.7		0.0	0.1	
Ref Time Seperate (s)	0.1	9.2		0.8	12.6		4.3	0.0		0.1	0.0	
Reference Time (s)	12.5	12.5		13.5	13.5		4.7	4.7		0.1	0.1	
Adj Reference Time (s)	16.5	16.5		17.5	17.5		8.7	8.7		8.0	8.0	
Summary												
	EB WB		NB SB		Combined							
Protected Option (s)	NA		NA									
Permitted Option (s)	25.8		8.4									
Split Option (s)	34.0		16.7									
Minimum (s)	25.8		8.4		34.1							
Right Turns												
Adj Reference Time (s)												
Cross Thru Ref Time (s)												
Oncoming Left Ref Time (s)												
Combined (s)												
Intersection Summary												
Intersection Capacity Utilization			28.5%		ICU Level of Service		A					
Reference Times and Phasing Options do not represent an optimized timing plan.												

Lanes and Geometrics

3: Downers Drive & Butterfield Road

11/20/2025

Lane Group	EBL	EBT	EBR	WBL	WBT	WBR	NBL	NBT	NBR	SBL	SBT	SBR
Lane Configurations												
Traffic Volume (vph)	172	1159	28	420	1422	344	53	40	39	316	74	177
Future Volume (vph)	172	1159	28	420	1422	344	53	40	39	316	74	177
Ideal Flow (vphp)	1900	2000	1900	1900	2000	1900	1900	1900	1900	1900	1900	1900
Storage Length (ft)	230		280	350		335	0		0	0		150
Storage Lanes	2		1	2		1	1		0	1		1
Taper Length (ft)	300			300			25			0		
Lane Util. Factor	0.97	0.91	1.00	0.97	0.91	1.00	1.00	1.00	1.00	1.00	1.00	1.00
Frt			0.850			0.850		0.926				0.850
Flt Protected	0.950			0.950			0.950			0.950		
Satd. Flow (prot)	3467	5460	1615	3467	5406	1615	1805	1734	0	1787	1863	1615
Flt Permitted	0.950			0.950			0.708			0.520		
Satd. Flow (perm)	3467	5460	1615	3467	5406	1615	1345	1734	0	978	1863	1615
Right Turn on Red			Yes			Yes			Yes			Yes
Satd. Flow (RTOR)			207			347		39				179
Link Speed (mph)		45			45			25				25
Link Distance (ft)		967			826			734				471
Travel Time (s)		14.7			12.5			20.0				12.8
Peak Hour Factor	0.99	0.99	0.99	0.99	0.99	0.99	0.99	0.99	0.99	0.99	0.99	0.99
Heavy Vehicles (%)	1%	0%	0%	1%	1%	0%	0%	0%	3%	1%	2%	0%
Shared Lane Traffic (%)												
Lane Group Flow (vph)	174	1171	28	424	1436	347	54	79	0	319	75	179
Turn Type	Prot	NA	Perm	Prot	NA	Perm	pm+pt	NA		pm+pt	NA	pm+ov
Protected Phases	5	2		1	6		3	8		7	4	5
Permitted Phases			2			6	8			4		4
Detector Phase	5	2	2	1	6	6	3	8		7	4	5
Switch Phase												
Minimum Initial (s)	3.0	15.0	15.0	3.0	15.0	15.0	3.0	8.0		3.0	8.0	3.0
Minimum Split (s)	7.5	21.0	21.0	7.5	21.0	21.0	6.5	14.0		6.5	14.0	7.5
Total Split (s)	13.0	38.0	38.0	21.0	46.0	46.0	15.0	20.0		21.0	26.0	13.0
Total Split (%)	13.0%	38.0%	38.0%	21.0%	46.0%	46.0%	15.0%	20.0%		21.0%	26.0%	13.0%
Yellow Time (s)	3.5	4.5	4.5	3.5	4.5	4.5	3.5	4.5		3.5	4.5	3.5
All-Red Time (s)	1.0	1.5	1.5	1.0	1.5	1.5	0.0	1.5		0.0	1.5	1.0
Lost Time Adjust (s)	0.0	0.0	0.0	0.0	0.0	0.0	0.0	0.0		0.0	0.0	0.0
Total Lost Time (s)	4.5	6.0	6.0	4.5	6.0	6.0	3.5	6.0		3.5	6.0	4.5
Lead/Lag	Lead	Lag	Lag	Lead	Lag	Lag	Lead	Lag		Lead	Lag	Lead
Lead-Lag Optimize?	Yes	Yes	Yes	Yes	Yes	Yes	Yes	Yes		Yes	Yes	Yes
Recall Mode	None	C-Min	C-Min	None	C-Min	C-Min	None	None		None	None	None
Act Effct Green (s)	8.9	38.3	38.3	16.0	45.3	45.3	19.3	11.7		31.7	20.0	35.0
Actuated g/C Ratio	0.09	0.38	0.38	0.16	0.45	0.45	0.19	0.12		0.32	0.20	0.35
v/c Ratio	0.56	0.56	0.04	0.77	0.59	0.38	0.18	0.33		0.71	0.20	0.26
Control Delay (s/veh)	51.1	27.2	0.1	50.2	23.0	3.5	23.4	26.6		36.7	33.6	4.4
Queue Delay	0.0	0.0	0.0	0.0	0.0	0.0	0.0	0.0		0.0	0.0	0.0
Total Delay (s/veh)	51.1	27.2	0.1	50.2	23.0	3.5	23.4	26.6		36.7	33.6	4.4
LOS	D	C	A	D	C	A	C	C		D	C	A
Approach Delay (s/veh)		29.7			25.1			25.3				26.2
Approach LOS		C			C			C				C
Queue Length 50th (ft)	55	229	0	133	267	0	23	23		160	40	0
Queue Length 95th (ft)	91	285	0	188	323	54	48	66		235	79	43

Lanes and Geometrics

3: Downers Drive & Butterfield Road

11/20/2025

Lane Group	EBL	EBT	EBR	WBL	WBT	WBR	NBL	NBT	NBR	SBL	SBT	SBR
Internal Link Dist (ft)		887			746			654			391	
Turn Bay Length (ft)	230		280	350		335						150
Base Capacity (vph)	316	2092	746	584	2450	922	366	276		455	398	684
Starvation Cap Reductn	0	0	0	0	0	0	0	0		0	0	0
Spillback Cap Reductn	0	0	0	0	0	0	0	0		0	0	0
Storage Cap Reductn	0	0	0	0	0	0	0	0		0	0	0
Reduced v/c Ratio	0.55	0.56	0.04	0.73	0.59	0.38	0.15	0.29		0.70	0.19	0.26

Intersection Summary

Area Type:	Other
Cycle Length:	100
Actuated Cycle Length:	100
Offset:	0 (0%), Referenced to phase 2:EBT and 6:WBT, Start of Green
Natural Cycle:	60
Control Type:	Actuated-Coordinated
Maximum v/c Ratio:	0.77
Intersection Signal Delay (s/veh):	26.7
Intersection LOS:	C
Intersection Capacity Utilization:	71.2%
ICU Level of Service:	C
Analysis Period (min):	15

Splits and Phases: 3: Downers Drive & Butterfield Road

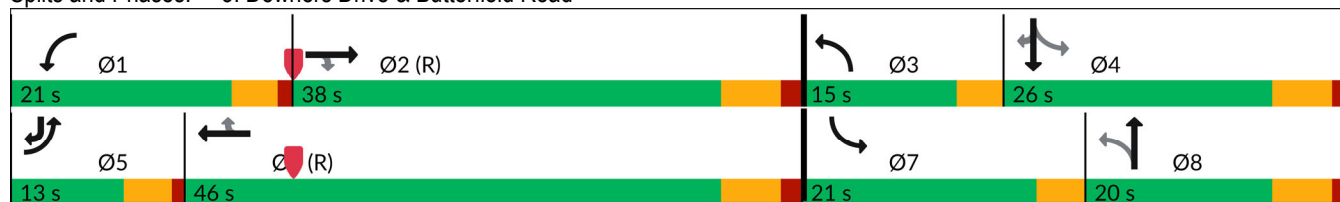

Lanes and Geometrics

8: Downers Drive & Access Road

11/20/2025



Lane Group	EBL	EBT	EBR	WBL	WBT	WBR	NBL	NBT	NBR	SBL	SBT	SBR
Lane Configurations		↕	↗	↖	↘			↕			↕	
Traffic Volume (vph)	5	97	315	244	74	18	358	8	189	6	8	6
Future Volume (vph)	5	97	315	244	74	18	358	8	189	6	8	6
Ideal Flow (vphp)	1900	1900	1900	1900	1900	1900	1900	1900	1900	1900	1900	1900
Storage Length (ft)	0		40	0		0	0		0	0		0
Storage Lanes	0		1	1		0	0		0	0		0
Taper Length (ft)	25			25			25			25		
Lane Util. Factor	1.00	1.00	1.00	1.00	1.00	1.00	0.95	0.95	0.95	0.95	0.95	0.95
Frt			0.850		0.970			0.949			0.955	
Flt Protected		0.998		0.950				0.969			0.985	
Satd. Flow (prot)	0	1896	1615	1805	1843	0	0	3308	0	0	3032	0
Flt Permitted		0.986		0.689				0.781			0.838	
Satd. Flow (perm)	0	1873	1615	1309	1843	0	0	2666	0	0	2580	0
Right Turn on Red			Yes			Yes			Yes			Yes
Satd. Flow (RTOR)			328		19			197			6	
Link Speed (mph)		20			20			25			25	
Link Distance (ft)		252			487			471			398	
Travel Time (s)		8.6			16.6			12.8			10.9	
Peak Hour Factor	0.96	0.96	0.96	0.96	0.96	0.96	0.96	0.96	0.96	0.96	0.96	0.96
Heavy Vehicles (%)	0%	0%	0%	0%	0%	0%	0%	25%	0%	0%	30%	0%
Shared Lane Traffic (%)												
Lane Group Flow (vph)	0	106	328	254	96	0	0	578	0	0	20	0
Turn Type	Perm	NA	Perm	Perm	NA		Perm	NA		Perm	NA	
Protected Phases		4			8			2			6	
Permitted Phases	4		4	8			2			6		
Detector Phase	4	4	4	8	8		2	2		6	6	
Switch Phase												
Minimum Initial (s)	8.0	8.0	8.0	5.0	5.0		8.0	8.0		8.0	8.0	
Minimum Split (s)	14.0	14.0	14.0	14.0	14.0		14.0	14.0		14.0	14.0	
Total Split (s)	20.0	20.0	20.0	20.0	20.0		40.0	40.0		40.0	40.0	
Total Split (%)	33.3%	33.3%	33.3%	33.3%	33.3%		66.7%	66.7%		66.7%	66.7%	
Yellow Time (s)	4.5	4.5	4.5	4.5	4.5		4.5	4.5		4.5	4.5	
All-Red Time (s)	1.5	1.5	1.5	1.5	1.5		1.5	1.5		1.5	1.5	
Lost Time Adjust (s)		0.0	0.0	0.0	0.0			0.0			0.0	
Total Lost Time (s)		6.0	6.0	6.0	6.0			6.0			6.0	
Lead/Lag												
Lead-Lag Optimize?												
Recall Mode	None	None	None	None	None		Min	Min		Min	Min	
Act Effct Green (s)		12.9	12.9	12.9	12.9			16.9			16.9	
Actuated g/C Ratio		0.31	0.31	0.31	0.31			0.40			0.40	
v/c Ratio		0.19	0.46	0.64	0.17			0.49			0.02	
Control Delay (s/veh)		14.1	4.8	25.3	11.9			7.2			5.9	
Queue Delay		0.0	0.0	0.0	0.0			0.0			0.0	
Total Delay (s/veh)		14.1	4.8	25.3	11.9			7.2			5.9	
LOS		B	A	C	B			A			A	
Approach Delay (s/veh)		7.0			21.6			7.2			5.9	
Approach LOS		A			C			A			A	
Queue Length 50th (ft)		18	0	50	13			38			1	
Queue Length 95th (ft)		59	50	#176	49			70			6	

Lanes and Geometrics

8: Downers Drive & Access Road

11/20/2025

Lane Group	EBL	EBT	EBR	WBL	WBT	WBR	NBL	NBT	NBR	SBL	SBT	SBR
Internal Link Dist (ft)		172			407			391			318	
Turn Bay Length (ft)			40									
Base Capacity (vph)		645	771	451	647			2203			2097	
Starvation Cap Reductn		0	0	0	0			0			0	
Spillback Cap Reductn		0	0	0	0			0			0	
Storage Cap Reductn		0	0	0	0			0			0	
Reduced v/c Ratio		0.16	0.43	0.56	0.15			0.26			0.01	

Intersection Summary

Area Type:	Other
Cycle Length:	60
Actuated Cycle Length:	42.2
Natural Cycle:	40
Control Type:	Actuated-Uncoordinated
Maximum v/c Ratio:	0.64
Intersection Signal Delay (s/veh):	10.8
Intersection LOS:	B
Intersection Capacity Utilization:	56.7%
ICU Level of Service:	B
Analysis Period (min):	15
# 95th percentile volume exceeds capacity, queue may be longer.	
Queue shown is maximum after two cycles.	

Splits and Phases: 8: Downers Drive & Access Road



HCM 7th TWSC

7: Butterfield Road & Right-I/Right-Out Access Drive

11/20/2025

Intersection						
Int Delay, s/veh	0.8					
Movement	EBL	EBT	WBT	WBR	SBL	SBR
Lane Configurations		↑↑	↑↑↑			↑
Traffic Vol, veh/h	0	1514	2105	159	0	81
Future Vol, veh/h	0	1514	2105	159	0	81
Conflicting Peds, #/hr	0	0	0	0	0	0
Sign Control	Free	Free	Free	Free	Stop	Stop
RT Channelized	-	None	-	Free	-	Stop
Storage Length	-	-	-	-	-	0
Veh in Median Storage, #	-	0	0	-	0	-
Grade, %	-	0	0	-	0	-
Peak Hour Factor	99	99	99	99	99	99
Heavy Vehicles, %	0	1	1	1	0	0
Mvmt Flow	0	1529	2126	161	0	82

Major/Minor	Major1	Major2	Minor2
Conflicting Flow All	-	0	- 0 - 1063
Stage 1	-	-	- - -
Stage 2	-	-	- - -
Critical Hdwy	-	-	- - 7.1
Critical Hdwy Stg 1	-	-	- - -
Critical Hdwy Stg 2	-	-	- - -
Follow-up Hdwy	-	-	- - 3.9
Pot Cap-1 Maneuver	0	-	- 0 0 191
Stage 1	0	-	- 0 0 -
Stage 2	0	-	- 0 0 -
Platoon blocked, %	-	-	
Mov Cap-1 Maneuver	-	-	- - 191
Mov Cap-2 Maneuver	-	-	- - -
Stage 1	-	-	- - -
Stage 2	-	-	- - -

Approach	EB	WB	SB
HCM Ctrl Dly, s/v	0	0	37.28
HCM LOS			E

Minor Lane/Major Mvmt	EBT	WBT	SBLn1
Capacity (veh/h)	-	-	191
HCM Lane V/C Ratio	-	-	0.428
HCM Ctrl Dly (s/v)	-	-	37.3
HCM Lane LOS	-	-	E
HCM 95th %tile Q(veh)	-	-	2

Capacity Analysis Summary Sheets
Year 2031 Total Projected Weekday Morning Peak Hour

Intersection Capacity Utilization 12: Access Drive & Access Road

11/24/2025



Movement	EBL	EBT	EBR	WBL	WBT	WBR	NBL	NBT	NBR	SBL	SBT	SBR
Lane Configurations		↕			↕			↕			↕	
Volume (vph)	0	28	32	0	27	0	65	0	0	0	0	1
Pedestrians												
Ped Button												
Pedestrian Timing (s)												
Free Right			No			No			No			No
Ideal Flow	1900	1900	1900	1900	1900	1900	1900	1900	1900	1900	1900	1900
Lost Time (s)	4.0	4.0	4.0	4.0	4.0	4.0	4.0	4.0	4.0	4.0	4.0	4.0
Minimum Green (s)	4.0	4.0	4.0	4.0	4.0	4.0	4.0	4.0	4.0	4.0	4.0	4.0
Refr Cycle Length (s)	120	120	120	120	120	120	120	120	120	120	120	120
Volume Combined (vph)	0	60	0	0	27	0	0	65	0	0	0	1
Lane Utilization Factor	1.00	1.00	1.00	1.00	1.00	1.00	1.00	1.00	1.00	1.00	1.00	1.00
Turning Factor (vph)	0.95	0.92	0.85	0.95	1.00	0.85	0.95	0.95	0.85	0.95	0.85	0.85
Saturated Flow (vph)	0	1748	0	0	1900	0	0	1805	0	0	1615	0
Ped Intf Time (s)	0.0	0.0	0.0	0.0	0.0	0.0	0.0	0.0	0.0	0.0	0.0	0.0
Pedestrian Frequency (%)		0.00			0.00			0.00			0.00	
Protected Option Allowed		No			No			No			No	
Reference Time (s)			0.0			0.0			0.0			0.0
Adj Reference Time (s)			0.0			0.0			0.0			0.0
Permitted Option												
Adj Saturation A (vph)	0	1748		0	1900		0	120		0	1615	
Reference Time A (s)	0.0	4.1		0.0	1.7		0.0	64.8		0.0	0.1	
Adj Saturation B (vph)	0	1748		0	1900		0	0		0	1615	
Reference Time B (s)	0.0	4.1		0.0	1.7		12.3	12.3		0.0	0.1	
Reference Time (s)		4.1			1.7			12.3			0.1	
Adj Reference Time (s)		8.1			8.0			16.3			8.0	
Split Option												
Ref Time Combined (s)	0.0	4.1		0.0	1.7		0.0	4.3		0.0	0.1	
Ref Time Seperate (s)	0.0	1.9		0.0	1.7		4.3	0.0		0.0	0.0	
Reference Time (s)	4.1	4.1		1.7	1.7		4.3	4.3		0.1	0.1	
Adj Reference Time (s)	8.1	8.1		8.0	8.0		8.3	8.3		8.0	8.0	
Summary												
	EB WB		NB SB		Combined							
Protected Option (s)	NA		NA									
Permitted Option (s)	8.1		16.3									
Split Option (s)	16.1		16.3									
Minimum (s)	8.1		16.3		24.4							
Right Turns												
Adj Reference Time (s)												
Cross Thru Ref Time (s)												
Oncoming Left Ref Time (s)												
Combined (s)												
Intersection Summary												
Intersection Capacity Utilization			20.4%		ICU Level of Service		A					
Reference Times and Phasing Options do not represent an optimized timing plan.												

Lanes and Geometrics

3: Downers Drive & Butterfield Road

11/24/2025

Lane Group	EBL	EBT	EBR	WBL	WBT	WBR	NBL	NBT	NBR	SBL	SBT	SBR
Lane Configurations												
Traffic Volume (vph)	122	1671	160	378	1261	232	19	17	35	139	39	98
Future Volume (vph)	122	1671	160	378	1261	232	19	17	35	139	39	98
Ideal Flow (vphp)	1900	2000	1900	1900	2000	1900	1900	1900	1900	1900	1900	1900
Storage Length (ft)	230		280	350		335	0		0	0		150
Storage Lanes	2		1	2		1	1		0	1		1
Taper Length (ft)	300			300			25			0		
Lane Util. Factor	0.97	0.91	1.00	0.97	0.91	1.00	1.00	1.00	1.00	1.00	1.00	1.00
Frt			0.850			0.850		0.899				0.850
Flt Protected	0.950			0.950			0.950			0.950		
Satd. Flow (prot)	3400	5353	1599	3467	5301	1583	1805	1632	0	1736	1845	1482
Flt Permitted	0.950			0.950			0.730			0.507		
Satd. Flow (perm)	3400	5353	1599	3467	5301	1583	1387	1632	0	926	1845	1482
Right Turn on Red			Yes			Yes			Yes			Yes
Satd. Flow (RTOR)			168			244		37				103
Link Speed (mph)		45			45			25				25
Link Distance (ft)		967			826			734				471
Travel Time (s)		14.7			12.5			20.0				12.8
Peak Hour Factor	0.95	0.95	0.95	0.95	0.95	0.95	0.95	0.95	0.95	0.95	0.95	0.95
Heavy Vehicles (%)	3%	2%	1%	1%	3%	2%	0%	8%	3%	4%	3%	9%
Shared Lane Traffic (%)												
Lane Group Flow (vph)	128	1759	168	398	1327	244	20	55	0	146	41	103
Turn Type	Prot	NA	Perm	Prot	NA	Perm	pm+pt	NA		pm+pt	NA	pm+ov
Protected Phases	5	2		1	6		3	8		7	4	5
Permitted Phases			2			6	8			4		4
Detector Phase	5	2	2	1	6	6	3	8		7	4	5
Switch Phase												
Minimum Initial (s)	3.0	15.0	15.0	3.0	15.0	15.0	3.0	8.0		3.0	8.0	3.0
Minimum Split (s)	7.5	21.0	21.0	7.5	21.0	21.0	6.5	14.0		6.5	14.0	7.5
Total Split (s)	13.0	68.0	68.0	24.0	79.0	79.0	12.0	21.0		12.0	21.0	13.0
Total Split (%)	10.4%	54.4%	54.4%	19.2%	63.2%	63.2%	9.6%	16.8%		9.6%	16.8%	10.4%
Yellow Time (s)	3.5	4.5	4.5	3.5	4.5	4.5	3.5	4.5		3.5	4.5	3.5
All-Red Time (s)	1.0	1.5	1.5	1.0	1.5	1.5	0.0	1.5		0.0	1.5	1.0
Lost Time Adjust (s)	0.0	0.0	0.0	0.0	0.0	0.0	0.0	0.0		0.0	0.0	0.0
Total Lost Time (s)	4.5	6.0	6.0	4.5	6.0	6.0	3.5	6.0		3.5	6.0	4.5
Lead/Lag	Lead	Lag	Lag	Lead	Lag	Lag	Lead	Lag		Lead	Lag	Lead
Lead-Lag Optimize?	Yes	Yes	Yes	Yes	Yes	Yes	Yes	Yes		Yes	Yes	Yes
Recall Mode	None	C-Min	C-Min	None	C-Min	C-Min	None	None		None	None	None
Act Effct Green (s)	9.8	70.7	70.7	19.2	80.1	80.1	16.1	9.0		20.0	14.1	29.9
Actuated g/C Ratio	0.08	0.57	0.57	0.15	0.64	0.64	0.13	0.07		0.16	0.11	0.24
v/c Ratio	0.48	0.58	0.17	0.75	0.39	0.22	0.10	0.36		0.71	0.20	0.24
Control Delay (s/veh)	61.0	19.7	2.8	59.7	11.9	1.9	42.2	31.4		66.1	53.1	8.7
Queue Delay	0.0	0.0	0.0	0.0	0.0	0.0	0.0	0.0		0.0	0.0	0.0
Total Delay (s/veh)	61.0	19.7	2.8	59.7	11.9	1.9	42.2	31.4		66.1	53.1	8.7
LOS	E	B	A	E	B	A	D	C		E	D	A
Approach Delay (s/veh)		20.9			20.3			34.3				43.8
Approach LOS		C			C			C				D
Queue Length 50th (ft)	53	338	0	161	186	0	14	15		110	30	0
Queue Length 95th (ft)	85	439	36	211	247	35	35	59		#177	70	50

Lanes and Geometrics

3: Downers Drive & Butterfield Road

11/24/2025



Lane Group	EBL	EBT	EBR	WBL	WBT	WBR	NBL	NBT	NBR	SBL	SBT	SBR
Internal Link Dist (ft)		887			746			654			391	
Turn Bay Length (ft)	230		280	350		335						150
Base Capacity (vph)	273	3027	977	568	3395	1101	227	228		205	251	436
Starvation Cap Reductn	0	0	0	0	0	0	0	0		0	0	0
Spillback Cap Reductn	0	0	0	0	0	0	0	0		0	0	0
Storage Cap Reductn	0	0	0	0	0	0	0	0		0	0	0
Reduced v/c Ratio	0.47	0.58	0.17	0.70	0.39	0.22	0.09	0.24		0.71	0.16	0.24

Intersection Summary

Area Type: Other
 Cycle Length: 125
 Actuated Cycle Length: 125
 Offset: 0 (0%), Referenced to phase 2:EBT and 6:WBT, Start of Green
 Natural Cycle: 65
 Control Type: Actuated-Coordinated
 Maximum v/c Ratio: 0.75
 Intersection Signal Delay (s/veh): 22.4 Intersection LOS: C
 Intersection Capacity Utilization 69.6% ICU Level of Service C
 Analysis Period (min) 15
 # 95th percentile volume exceeds capacity, queue may be longer.
 Queue shown is maximum after two cycles.

Splits and Phases: 3: Downers Drive & Butterfield Road

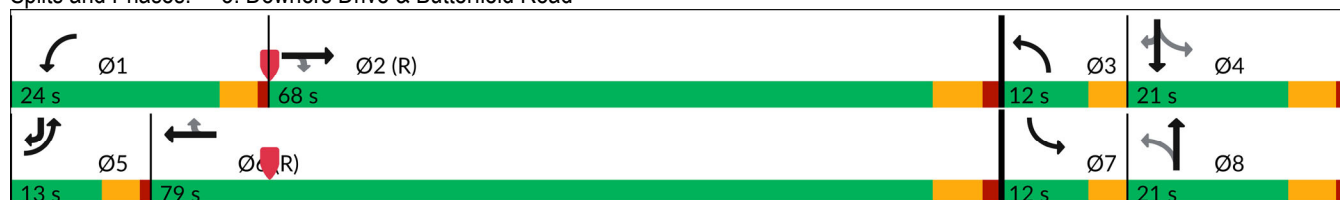

Lanes and Geometrics

8: Downers Drive & Access Road

11/24/2025



Lane Group	EBL	EBT	EBR	WBL	WBT	WBR	NBL	NBT	NBR	SBL	SBT	SBR
Lane Configurations		↕	↗	↖	↗	↖		↕			↕	
Traffic Volume (vph)	11	10	123	137	8	6	191	70	110	6	15	3
Future Volume (vph)	11	10	123	137	8	6	191	70	110	6	15	3
Ideal Flow (vphp)	1900	1900	1900	1900	1900	1900	1900	1900	1900	1900	1900	1900
Storage Length (ft)	0		40	0		0	0		0	0		0
Storage Lanes	0		1	1		0	0		0	0		0
Taper Length (ft)	25			25			25			25		
Lane Util. Factor	1.00	1.00	1.00	1.00	1.00	1.00	0.95	0.95	0.95	0.95	0.95	0.95
Frt			0.850		0.934			0.956			0.983	
Flt Protected		0.975		0.950				0.975			0.987	
Satd. Flow (prot)	0	1852	1599	1805	1775	0	0	3276	0	0	2911	0
Flt Permitted		0.835		0.742				0.800			0.875	
Satd. Flow (perm)	0	1586	1599	1410	1775	0	0	2688	0	0	2581	0
Right Turn on Red			Yes			Yes			Yes			Yes
Satd. Flow (RTOR)			135		7			121			3	
Link Speed (mph)		20			20			25			25	
Link Distance (ft)		252			487			471			398	
Travel Time (s)		8.6			16.6			12.8			10.9	
Peak Hour Factor	0.91	0.91	0.91	0.91	0.91	0.91	0.91	0.91	0.91	0.91	0.91	0.91
Heavy Vehicles (%)	0%	0%	1%	0%	0%	0%	2%	9%	0%	0%	33%	0%
Shared Lane Traffic (%)												
Lane Group Flow (vph)	0	23	135	151	16	0	0	408	0	0	26	0
Turn Type	Perm	NA	Perm	Perm	NA		Perm	NA		Perm	NA	
Protected Phases		4			8			2			6	
Permitted Phases	4		4	8			2			6		
Detector Phase	4	4	4	8	8		2	2		6	6	
Switch Phase												
Minimum Initial (s)	8.0	8.0	8.0	8.0	8.0		15.0	15.0		15.0	15.0	
Minimum Split (s)	14.0	14.0	14.0	14.0	14.0		24.0	24.0		24.0	24.0	
Total Split (s)	14.0	14.0	14.0	14.0	14.0		66.0	66.0		66.0	66.0	
Total Split (%)	17.5%	17.5%	17.5%	17.5%	17.5%		82.5%	82.5%		82.5%	82.5%	
Yellow Time (s)	4.5	4.5	4.5	4.5	4.5		4.5	4.5		4.5	4.5	
All-Red Time (s)	1.5	1.5	1.5	1.5	1.5		1.5	1.5		1.5	1.5	
Lost Time Adjust (s)		0.0	0.0	0.0	0.0			0.0			0.0	
Total Lost Time (s)		6.0	6.0	6.0	6.0			6.0			6.0	
Lead/Lag												
Lead-Lag Optimize?												
Recall Mode	None	None	None	None	None		Min	Min		Min	Min	
Act Effct Green (s)		8.1	8.1	8.1	8.1			21.3			21.3	
Actuated g/C Ratio		0.20	0.20	0.20	0.20			0.51			0.51	
v/c Ratio		0.07	0.32	0.55	0.05			0.28			0.02	
Control Delay (s/veh)		16.0	6.7	27.0	12.9			4.4			4.4	
Queue Delay		0.0	0.0	0.0	0.0			0.0			0.0	
Total Delay (s/veh)		16.0	6.7	27.0	12.9			4.4			4.4	
LOS		B	A	C	B			A			A	
Approach Delay (s/veh)		8.1			25.6			4.4			4.4	
Approach LOS		A			C			A			A	
Queue Length 50th (ft)		4	0	29	2			17			1	
Queue Length 95th (ft)		21	36	#109	15			34			5	

Lanes and Geometrics

8: Downers Drive & Access Road

11/24/2025

Lane Group	EBL	EBT	EBR	WBL	WBT	WBR	NBL	NBT	NBR	SBL	SBT	SBR
Internal Link Dist (ft)		172			407			391			318	
Turn Bay Length (ft)			40									
Base Capacity (vph)		309	420	275	352			2688			2581	
Starvation Cap Reductn		0	0	0	0			0			0	
Spillback Cap Reductn		0	0	0	0			0			0	
Storage Cap Reductn		0	0	0	0			0			0	
Reduced v/c Ratio		0.07	0.32	0.55	0.05			0.15			0.01	

Intersection Summary

Area Type:	Other
Cycle Length:	80
Actuated Cycle Length:	41.5
Natural Cycle:	40
Control Type:	Actuated-Uncoordinated
Maximum v/c Ratio:	0.55
Intersection Signal Delay (s/veh):	9.8
Intersection LOS:	A
Intersection Capacity Utilization:	42.7%
ICU Level of Service:	A
Analysis Period (min):	15
# 95th percentile volume exceeds capacity, queue may be longer.	
Queue shown is maximum after two cycles.	

Splits and Phases: 8: Downers Drive & Access Road

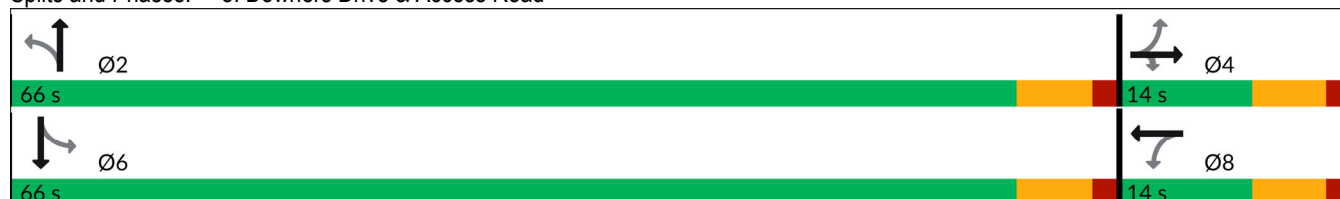

HCM 7th TWSC

7: Butterfield Road & Right-I/Right-Out Access Drive

11/24/2025

Intersection						
Int Delay, s/veh	0.2					
Movement	EBL	EBT	WBT	WBR	SBL	SBR
Lane Configurations		↑↑	↑↑↑			↑
Traffic Vol, veh/h	0	1845	1844	77	0	27
Future Vol, veh/h	0	1845	1844	77	0	27
Conflicting Peds, #/hr	0	0	0	0	0	0
Sign Control	Free	Free	Free	Free	Stop	Stop
RT Channelized	-	None	-	Free	-	Stop
Storage Length	-	-	-	-	-	0
Veh in Median Storage, #	-	0	0	-	0	-
Grade, %	-	0	0	-	0	-
Peak Hour Factor	95	95	95	95	95	95
Heavy Vehicles, %	0	2	2	0	0	14
Mvmt Flow	0	1942	1941	81	0	28

Major/Minor	Major1	Major2	Minor2
Conflicting Flow All	-	0	- 0 - 971
Stage 1	-	-	- - -
Stage 2	-	-	- - -
Critical Hdwy	-	-	- - 7.38
Critical Hdwy Stg 1	-	-	- - -
Critical Hdwy Stg 2	-	-	- - -
Follow-up Hdwy	-	-	- - 4.04
Pot Cap-1 Maneuver	0	-	- 0 0 200
Stage 1	0	-	- 0 0 -
Stage 2	0	-	- 0 0 -
Platoon blocked, %	-	-	- - -
Mov Cap-1 Maneuver	-	-	- - 200
Mov Cap-2 Maneuver	-	-	- - -
Stage 1	-	-	- - -
Stage 2	-	-	- - -

Approach	EB	WB	SB
HCM Ctrl Dly, s/v	0	0	25.95
HCM LOS			D

Minor Lane/Major Mvmt	EBT	WBT	SBLn1
Capacity (veh/h)	-	-	200
HCM Lane V/C Ratio	-	-	0.142
HCM Ctrl Dly (s/v)	-	-	26
HCM Lane LOS	-	-	D
HCM 95th %tile Q(veh)	-	-	0.5

Capacity Analysis Summary Sheets
Year 2031 Total Projected Weekday Evening Peak Hour

Intersection Capacity Utilization 12: Access Drive & Access Road

11/24/2025

Movement	EBL	EBT	EBR	WBL	WBT	WBR	NBL	NBT	NBR	SBL	SBT	SBR
Lane Configurations												
Volume (vph)	3	73	28	10	154	0	56	0	4	0	0	1
Pedestrians												
Ped Button												
Pedestrian Timing (s)												
Free Right	No			No			No			No		
Ideal Flow	1900	1900	1900	1900	1900	1900	1900	1900	1900	1900	1900	1900
Lost Time (s)	4.0	4.0	4.0	4.0	4.0	4.0	4.0	4.0	4.0	4.0	4.0	4.0
Minimum Green (s)	4.0	4.0	4.0	4.0	4.0	4.0	4.0	4.0	4.0	4.0	4.0	4.0
Refr Cycle Length (s)	120	120	120	120	120	120	120	120	120	120	120	120
Volume Combined (vph)	0	104	0	0	164	0	0	60	0	0	1	0
Lane Utilization Factor	1.00	1.00	1.00	1.00	1.00	1.00	1.00	1.00	1.00	1.00	1.00	1.00
Turning Factor (vph)	0.95	0.96	0.85	0.95	1.00	0.85	0.95	0.94	0.85	0.95	0.85	0.85
Saturated Flow (vph)	0	1821	0	0	1894	0	0	1793	0	0	1615	0
Ped Intf Time (s)	0.0	0.0	0.0	0.0	0.0	0.0	0.0	0.0	0.0	0.0	0.0	0.0
Pedestrian Frequency (%)	0.00		0.00			0.00			0.00			
Protected Option Allowed	No			No			No			No		
Reference Time (s)	0.0			0.0			0.0			0.0		
Adj Reference Time (s)	0.0			0.0			0.0			0.0		
Permitted Option												
Adj Saturation A (vph)	0	1612	0	1298	0	125	0	1615	0	1615	0	1615
Reference Time A (s)	0.0	7.7	0.0	15.2	0.0	57.6	0.0	0.1	0.0	0.1	0.0	0.1
Adj Saturation B (vph)	NA	NA	0	0	0	0	0	1615	0	1615	0	1615
Reference Time B (s)	NA	NA	8.7	18.4	11.7	12.0	0.0	0.1	0.0	0.1	0.0	0.1
Reference Time (s)	7.7		15.2			12.0			0.1			
Adj Reference Time (s)	11.7		19.2			16.0			8.0			
Split Option												
Ref Time Combined (s)	0.0	6.9	0.0	10.4	0.0	4.0	0.0	0.1	0.0	0.1	0.0	0.1
Ref Time Seperate (s)	0.2	4.8	0.7	9.7	3.7	0.0	0.0	0.0	0.0	0.0	0.0	0.0
Reference Time (s)	6.9	6.9	10.4	10.4	4.0	4.0	0.1	0.1	0.1	0.1	0.1	0.1
Adj Reference Time (s)	10.9	10.9	14.4	14.4	8.0	8.0	8.0	8.0	8.0	8.0	8.0	8.0
Summary	EB WB		NB SB		Combined							
Protected Option (s)	NA		NA									
Permitted Option (s)	19.2		16.0									
Split Option (s)	25.2		16.0									
Minimum (s)	19.2		16.0		35.2							
Right Turns												
Adj Reference Time (s)												
Cross Thru Ref Time (s)												
Oncoming Left Ref Time (s)												
Combined (s)												
Intersection Summary												
Intersection Capacity Utilization	29.3%		ICU Level of Service						A			
Reference Times and Phasing Options do not represent an optimized timing plan.												

Lanes and Geometrics

3: Downers Drive & Butterfield Road

11/24/2025

Lane Group	EBL	EBT	EBR	WBL	WBT	WBR	NBL	NBT	NBR	SBL	SBT	SBR
Lane Configurations												
Traffic Volume (vph)	132	1533	104	789	1849	260	100	33	119	323	70	186
Future Volume (vph)	132	1533	104	789	1849	260	100	33	119	323	70	186
Ideal Flow (vphp)	1900	2000	1900	1900	2000	1900	1900	1900	1900	1900	1900	1900
Storage Length (ft)	230		280	350		335	0		0	0		150
Storage Lanes	2		1	2		1	1		0	1		1
Taper Length (ft)	300			300			25			0		
Lane Util. Factor	0.97	0.91	1.00	0.97	0.91	1.00	1.00	1.00	1.00	1.00	1.00	1.00
Frt			0.850			0.850		0.882				0.850
Flt Protected	0.950			0.950			0.950			0.950		
Satd. Flow (prot)	3400	5353	1599	3467	5406	1615	1805	1676	0	1787	1845	1599
Flt Permitted	0.950			0.950			0.709			0.290		
Satd. Flow (perm)	3400	5353	1599	3467	5406	1615	1347	1676	0	546	1845	1599
Right Turn on Red			Yes			Yes			Yes			Yes
Satd. Flow (RTOR)			154			271		108				89
Link Speed (mph)		45			45			25				25
Link Distance (ft)		967			826			734				471
Travel Time (s)		14.7			12.5			20.0				12.8
Peak Hour Factor	0.96	0.96	0.96	0.96	0.96	0.96	0.96	0.96	0.96	0.96	0.96	0.96
Heavy Vehicles (%)	3%	2%	1%	1%	1%	0%	0%	0%	0%	1%	3%	1%
Shared Lane Traffic (%)												
Lane Group Flow (vph)	138	1597	108	822	1926	271	104	158	0	336	73	194
Turn Type	Prot	NA	Perm	Prot	NA	Perm	pm+pt	NA		pm+pt	NA	pm+ov
Protected Phases	5	2		1	6		3	8		7	4	5
Permitted Phases			2			6	8			4		4
Detector Phase	5	2	2	1	6	6	3	8		7	4	5
Switch Phase												
Minimum Initial (s)	3.0	15.0	15.0	3.0	15.0	15.0	3.0	8.0		3.0	8.0	3.0
Minimum Split (s)	7.5	21.0	21.0	7.5	21.0	21.0	6.5	14.0		6.5	14.0	7.5
Total Split (s)	13.0	49.0	49.0	44.0	80.0	80.0	14.0	19.0		23.0	28.0	13.0
Total Split (%)	9.6%	36.3%	36.3%	32.6%	59.3%	59.3%	10.4%	14.1%		17.0%	20.7%	9.6%
Yellow Time (s)	3.5	4.5	4.5	3.5	4.5	4.5	3.5	4.5		3.5	4.5	3.5
All-Red Time (s)	1.0	1.5	1.5	1.0	1.5	1.5	0.0	1.5		0.0	1.5	1.0
Lost Time Adjust (s)	0.0	0.0	0.0	0.0	0.0	0.0	0.0	0.0		-1.0	0.0	0.0
Total Lost Time (s)	4.5	6.0	6.0	4.5	6.0	6.0	3.5	6.0		2.5	6.0	4.5
Lead/Lag	Lead	Lag	Lag	Lead	Lag	Lag	Lead	Lag		Lead	Lag	Lead
Lead-Lag Optimize?	Yes	Yes	Yes	Yes	Yes	Yes	Yes	Yes		Yes	Yes	Yes
Recall Mode	None	C-Min	C-Min	None	C-Min	C-Min	None	None		None	None	None
Act Effct Green (s)	9.1	48.8	48.8	36.4	76.1	76.1	25.6	10.2		33.9	17.6	29.9
Actuated g/C Ratio	0.07	0.36	0.36	0.27	0.56	0.56	0.19	0.08		0.25	0.13	0.22
v/c Ratio	0.60	0.82	0.16	0.88	0.63	0.26	0.34	0.70		1.03	0.31	0.46
Control Delay (s/veh)	72.6	44.4	1.9	58.6	21.4	2.3	42.1	37.8		103.9	54.9	25.6
Queue Delay	0.0	0.0	0.0	0.0	0.0	0.0	0.0	0.0		0.0	0.0	0.0
Total Delay (s/veh)	72.6	44.4	1.9	58.6	21.4	2.3	42.1	37.8		103.9	54.9	25.6
LOS	E	D	A	E	C	A	D	D		F	D	C
Approach Delay (s/veh)		44.0			29.8			39.5			72.8	
Approach LOS		D			C			D			E	
Queue Length 50th (ft)	62	476	0	355	414	0	72	43		~270	60	74
Queue Length 95th (ft)	101	#602	13	428	472	40	120	118		#421	107	146

Lanes and Geometrics

3: Downers Drive & Butterfield Road

11/24/2025



Lane Group	EBL	EBT	EBR	WBL	WBT	WBR	NBL	NBT	NBR	SBL	SBT	SBR
Internal Link Dist (ft)		887			746			654			391	
Turn Bay Length (ft)	230		280	350		335						150
Base Capacity (vph)	233	1936	676	1017	3048	1028	308	258		325	300	425
Starvation Cap Reductn	0	0	0	0	0	0	0	0		0	0	0
Spillback Cap Reductn	0	0	0	0	0	0	0	0		0	0	0
Storage Cap Reductn	0	0	0	0	0	0	0	0		0	0	0
Reduced v/c Ratio	0.59	0.82	0.16	0.81	0.63	0.26	0.34	0.61		1.03	0.24	0.46

Intersection Summary	
Area Type:	Other
Cycle Length:	135
Actuated Cycle Length:	135
Offset:	63 (47%), Referenced to phase 2:EBT and 6:WBT, Start of Green
Natural Cycle:	90
Control Type:	Actuated-Coordinated
Maximum v/c Ratio:	1.03
Intersection Signal Delay (s/veh):	39.3
Intersection LOS:	D
Intersection Capacity Utilization:	94.7%
ICU Level of Service:	F
Analysis Period (min):	15
~ Volume exceeds capacity, queue is theoretically infinite. Queue shown is maximum after two cycles.	
# 95th percentile volume exceeds capacity, queue may be longer. Queue shown is maximum after two cycles.	

Splits and Phases: 3: Downers Drive & Butterfield Road

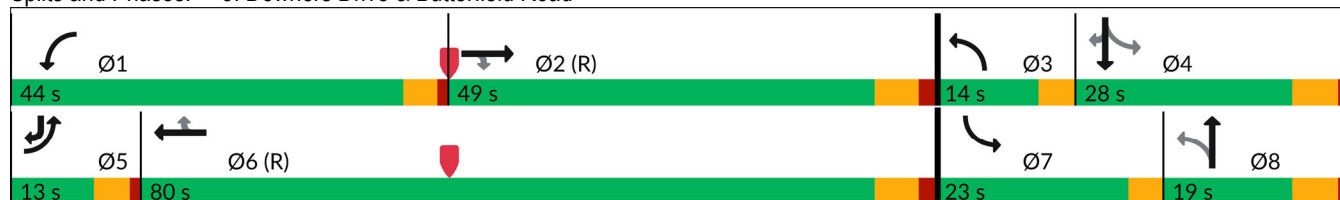

Lanes and Geometrics

8: Downers Drive & Access Road

11/24/2025



Lane Group	EBL	EBT	EBR	WBL	WBT	WBR	NBL	NBT	NBR	SBL	SBT	SBR
Lane Configurations		↕	↗	↖	↗	↖		↕			↕	
Traffic Volume (vph)	3	56	247	250	46	16	254	24	148	12	82	7
Future Volume (vph)	3	56	247	250	46	16	254	24	148	12	82	7
Ideal Flow (vphp)	1900	1900	1900	1900	1900	1900	1900	1900	1900	1900	1900	1900
Storage Length (ft)	0		40	0		0	0		0	0		0
Storage Lanes	0		1	1		0	0		0	0		0
Taper Length (ft)	25			25			25			25		
Lane Util. Factor	1.00	1.00	1.00	1.00	1.00	1.00	0.95	0.95	0.95	0.95	0.95	0.95
Frt			0.850		0.962			0.948			0.989	
Flt Protected		0.998		0.950				0.971			0.994	
Satd. Flow (prot)	0	1896	1615	1787	1828	0	0	3297	0	0	3385	0
Flt Permitted		0.988		0.715				0.745			0.896	
Satd. Flow (perm)	0	1877	1615	1345	1828	0	0	2529	0	0	3051	0
Right Turn on Red			Yes			Yes			Yes			Yes
Satd. Flow (RTOR)			268		17			161			8	
Link Speed (mph)		20		20				25			25	
Link Distance (ft)		252		487				471			398	
Travel Time (s)		8.6		16.6				12.8			10.9	
Peak Hour Factor	0.92	0.92	0.92	0.92	0.92	0.92	0.92	0.92	0.92	0.92	0.92	0.92
Heavy Vehicles (%)	0%	0%	0%	1%	0%	0%	0%	8%	1%	0%	6%	0%
Shared Lane Traffic (%)												
Lane Group Flow (vph)	0	64	268	272	67	0	0	463	0	0	110	0
Turn Type	Perm	NA	Perm	Perm	NA		Perm	NA		Perm	NA	
Protected Phases		4			8			2			6	
Permitted Phases	4		4	8			2			6		
Detector Phase	4	4	4	8	8		2	2		6	6	
Switch Phase												
Minimum Initial (s)	8.0	8.0	8.0	8.0	8.0		8.0	8.0		8.0	8.0	
Minimum Split (s)	14.0	14.0	14.0	14.0	14.0		14.0	14.0		14.0	14.0	
Total Split (s)	20.0	20.0	20.0	20.0	20.0		40.0	40.0		40.0	40.0	
Total Split (%)	33.3%	33.3%	33.3%	33.3%	33.3%		66.7%	66.7%		66.7%	66.7%	
Yellow Time (s)	4.5	4.5	4.5	4.5	4.5		4.5	4.5		4.5	4.5	
All-Red Time (s)	1.5	1.5	1.5	1.5	1.5		1.5	1.5		1.5	1.5	
Lost Time Adjust (s)		0.0	0.0	0.0	0.0			0.0			0.0	
Total Lost Time (s)		6.0	6.0	6.0	6.0			6.0			6.0	
Lead/Lag												
Lead-Lag Optimize?												
Recall Mode	None	None	None	None	None		Min	Min		Min	Min	
Act Effct Green (s)		13.7	13.7	13.7	13.7			21.9			21.9	
Actuated g/C Ratio		0.29	0.29	0.29	0.29			0.46			0.46	
v/c Ratio		0.12	0.41	0.71	0.13			0.37			0.08	
Control Delay (s/veh)		16.3	5.3	31.9	13.5			5.8			6.4	
Queue Delay		0.0	0.0	0.0	0.0			0.0			0.0	
Total Delay (s/veh)		16.3	5.3	31.9	13.5			5.8			6.4	
LOS		B	A	C	B			A			A	
Approach Delay (s/veh)		7.4			28.2			5.8			6.4	
Approach LOS		A			C			A			A	
Queue Length 50th (ft)		13	0	66	10			26			7	
Queue Length 95th (ft)		45	50	#217	41			48			17	

Lanes and Geometrics

8: Downers Drive & Access Road

11/24/2025

Lane Group	EBL	EBT	EBR	WBL	WBT	WBR	NBL	NBT	NBR	SBL	SBT	SBR
Internal Link Dist (ft)		172			407			391			318	
Turn Bay Length (ft)			40									
Base Capacity (vph)		564	673	404	561			1890			2230	
Starvation Cap Reductn		0	0	0	0			0			0	
Spillback Cap Reductn		0	0	0	0			0			0	
Storage Cap Reductn		0	0	0	0			0			0	
Reduced v/c Ratio		0.11	0.40	0.67	0.12			0.24			0.05	

Intersection Summary

Area Type:	Other
Cycle Length:	60
Actuated Cycle Length:	48
Natural Cycle:	40
Control Type:	Actuated-Uncoordinated
Maximum v/c Ratio:	0.71
Intersection Signal Delay (s/veh):	12.4
Intersection LOS:	B
Intersection Capacity Utilization:	51.3%
ICU Level of Service:	A
Analysis Period (min):	15
# 95th percentile volume exceeds capacity, queue may be longer.	
Queue shown is maximum after two cycles.	

Splits and Phases: 8: Downers Drive & Access Road



HCM 7th TWSC

7: Butterfield Road & Right-I/Right-Out Access Drive

11/24/2025

Intersection						
Int Delay, s/veh	0.8					
Movement	EBL	EBT	WBT	WBR	SBL	SBR
Lane Configurations		↑↑↑	↑↑↑			↑
Traffic Vol, veh/h	0	1975	2848	154	0	51
Future Vol, veh/h	0	1975	2848	154	0	51
Conflicting Peds, #/hr	0	0	0	0	0	0
Sign Control	Free	Free	Free	Free	Stop	Stop
RT Channelized	-	None	-	Free	-	Stop
Storage Length	-	-	-	-	-	0
Veh in Median Storage, #	-	0	0	-	0	-
Grade, %	-	0	0	-	0	-
Peak Hour Factor	95	95	95	95	95	95
Heavy Vehicles, %	0	1	1	0	0	0
Mvmt Flow	0	2079	2998	162	0	54

Major/Minor	Major1	Major2	Minor2
Conflicting Flow All	-	0	- 0 - 1499
Stage 1	-	-	- - -
Stage 2	-	-	- - -
Critical Hdwy	-	-	- - 7.1
Critical Hdwy Stg 1	-	-	- - -
Critical Hdwy Stg 2	-	-	- - -
Follow-up Hdwy	-	-	- - 3.9
Pot Cap-1 Maneuver	0	-	- 0 0 97
Stage 1	0	-	- 0 0 -
Stage 2	0	-	- 0 0 -
Platoon blocked, %	-	-	
Mov Cap-1 Maneuver	-	-	- - 97
Mov Cap-2 Maneuver	-	-	- - -
Stage 1	-	-	- - -
Stage 2	-	-	- - -

















Approach	EB	WB	SB
HCM Ctrl Dly, s/v	0	0	80.55
HCM LOS			F

Minor Lane/Major Mvmt	EBT	WBT	SBLn1
Capacity (veh/h)	-	-	97
HCM Lane V/C Ratio	-	-	0.553
HCM Ctrl Dly (s/v)	-	-	80.5
HCM Lane LOS	-	-	F
HCM 95th %tile Q(veh)	-	-	2.5

Capacity Analysis Summary Sheets
Year 2031 Total Projected Weekday Evening Peak Hour

Intersection Capacity Utilization 12: Access Drive & Access Road

11/24/2025

												
Movement	EBL	EBT	EBR	WBL	WBT	WBR	NBL	NBT	NBR	SBL	SBT	SBR
Lane Configurations												
Volume (vph)	2	140	48	12	200	1	71	0	5	2	0	0
Pedestrians												
Ped Button												
Pedestrian Timing (s)												
Free Right	No			No			No			No		
Ideal Flow	1900	1900	1900	1900	1900	1900	1900	1900	1900	1900	1900	1900
Lost Time (s)	4.0	4.0	4.0	4.0	4.0	4.0	4.0	4.0	4.0	4.0	4.0	4.0
Minimum Green (s)	4.0	4.0	4.0	4.0	4.0	4.0	4.0	4.0	4.0	4.0	4.0	4.0
Refr Cycle Length (s)	120	120	120	120	120	120	120	120	120	120	120	120
Volume Combined (vph)	0	190	0	0	213	0	0	76	0	0	2	0
Lane Utilization Factor	1.00	1.00	1.00	1.00	1.00	1.00	1.00	1.00	1.00	1.00	1.00	1.00
Turning Factor (vph)	0.95	0.96	0.85	0.95	1.00	0.85	0.95	0.94	0.85	0.95	0.95	0.85
Saturated Flow (vph)	0	1827	0	0	1893	0	0	1793	0	0	1805	0
Ped Intf Time (s)	0.0	0.0	0.0	0.0	0.0	0.0	0.0	0.0	0.0	0.0	0.0	0.0
Pedestrian Frequency (%)		0.00			0.00			0.00			0.00	
Protected Option Allowed		No			No			No			No	
Reference Time (s)			0.0			0.0			0.0			0.0
Adj Reference Time (s)			0.0			0.0			0.0			0.0
Permitted Option												
Adj Saturation A (vph)	0	1742		0	1173		0	1927		0	1807	
Reference Time A (s)	0.0	13.1		0.0	21.8		0.0	4.7		0.0	0.1	
Adj Saturation B (vph)	NA	NA		NA	NA		0	0		0	0	
Reference Time B (s)	NA	NA		NA	NA		12.7	13.1		8.1	8.1	
Reference Time (s)		13.1			21.8			4.7			0.1	
Adj Reference Time (s)		17.1			25.8			8.7			8.0	
Split Option												
Ref Time Combined (s)	0.0	12.5		0.0	13.5		0.0	5.1		0.0	0.1	
Ref Time Seperate (s)	0.1	9.2		0.8	12.6		4.7	0.0		0.1	0.0	
Reference Time (s)	12.5	12.5		13.5	13.5		5.1	5.1		0.1	0.1	
Adj Reference Time (s)	16.5	16.5		17.5	17.5		9.1	9.1		8.0	8.0	
Summary	EB WB	NB SB		Combined								
Protected Option (s)	NA	NA										
Permitted Option (s)	25.8	8.7										
Split Option (s)	34.0	17.1										
Minimum (s)	25.8	8.7		34.5								
Right Turns												
Adj Reference Time (s)												
Cross Thru Ref Time (s)												
Oncoming Left Ref Time (s)												
Combined (s)												
Intersection Summary												
Intersection Capacity Utilization	28.8%		ICU Level of Service					A				
Reference Times and Phasing Options do not represent an optimized timing plan.												

Lanes and Geometrics

3: Downers Drive & Butterfield Road

11/24/2025

Lane Group	EBL	EBT	EBR	WBL	WBT	WBR	NBL	NBT	NBR	SBL	SBT	SBR
Lane Configurations												
Traffic Volume (vph)	197	1147	28	420	1370	376	53	41	39	341	75	242
Future Volume (vph)	197	1147	28	420	1370	376	53	41	39	341	75	242
Ideal Flow (vphp)	1900	2000	1900	1900	2000	1900	1900	1900	1900	1900	1900	1900
Storage Length (ft)	230		280	350		335	0		0	0		150
Storage Lanes	2		1	2		1	1		0	1		1
Taper Length (ft)	300			300			25			0		
Lane Util. Factor	0.97	0.91	1.00	0.97	0.91	1.00	1.00	1.00	1.00	1.00	1.00	1.00
Frt			0.850			0.850		0.927				0.850
Flt Protected	0.950			0.950			0.950			0.950		
Satd. Flow (prot)	3467	5460	1615	3467	5406	1615	1805	1736	0	1787	1863	1615
Flt Permitted	0.950			0.950			0.708			0.519		
Satd. Flow (perm)	3467	5460	1615	3467	5406	1615	1345	1736	0	976	1863	1615
Right Turn on Red			Yes			Yes			Yes			Yes
Satd. Flow (RTOR)			207			380		39				207
Link Speed (mph)		45			45			25				25
Link Distance (ft)		967			826			734				471
Travel Time (s)		14.7			12.5			20.0				12.8
Peak Hour Factor	0.99	0.99	0.99	0.99	0.99	0.99	0.99	0.99	0.99	0.99	0.99	0.99
Heavy Vehicles (%)	1%	0%	0%	1%	1%	0%	0%	0%	3%	1%	2%	0%
Shared Lane Traffic (%)												
Lane Group Flow (vph)	199	1159	28	424	1384	380	54	80	0	344	76	244
Turn Type	Prot	NA	Perm	Prot	NA	Perm	pm+pt	NA		pm+pt	NA	pm+ov
Protected Phases	5	2		1	6		3	8		7	4	5
Permitted Phases			2			6	8			4		4
Detector Phase	5	2	2	1	6	6	3	8		7	4	5
Switch Phase												
Minimum Initial (s)	3.0	15.0	15.0	3.0	15.0	15.0	3.0	8.0		3.0	8.0	3.0
Minimum Split (s)	7.5	21.0	21.0	7.5	21.0	21.0	6.5	14.0		6.5	14.0	7.5
Total Split (s)	13.0	38.0	38.0	21.0	46.0	46.0	15.0	20.0		21.0	26.0	13.0
Total Split (%)	13.0%	38.0%	38.0%	21.0%	46.0%	46.0%	15.0%	20.0%		21.0%	26.0%	13.0%
Yellow Time (s)	3.5	4.5	4.5	3.5	4.5	4.5	3.5	4.5		3.5	4.5	3.5
All-Red Time (s)	1.0	1.5	1.5	1.0	1.5	1.5	0.0	1.5		0.0	1.5	1.0
Lost Time Adjust (s)	0.0	0.0	0.0	0.0	0.0	0.0	0.0	0.0		0.0	0.0	0.0
Total Lost Time (s)	4.5	6.0	6.0	4.5	6.0	6.0	3.5	6.0		3.5	6.0	4.5
Lead/Lag	Lead	Lag	Lag	Lead	Lag	Lag	Lead	Lag		Lead	Lag	Lead
Lead-Lag Optimize?	Yes	Yes	Yes	Yes	Yes	Yes	Yes	Yes		Yes	Yes	Yes
Recall Mode	None	C-Min	C-Min	None	C-Min	C-Min	None	None		None	None	None
Act Effct Green (s)	9.3	38.1	38.1	16.0	44.7	44.7	19.3	11.7		32.0	20.3	35.6
Actuated g/C Ratio	0.09	0.38	0.38	0.16	0.45	0.45	0.19	0.12		0.32	0.20	0.36
v/c Ratio	0.62	0.56	0.04	0.77	0.57	0.41	0.18	0.34		0.76	0.20	0.34
Control Delay (s/veh)	52.7	27.2	0.1	50.2	23.0	3.5	23.4	26.8		39.4	33.6	6.3
Queue Delay	0.0	0.0	0.0	0.0	0.0	0.0	0.0	0.0		0.0	0.0	0.0
Total Delay (s/veh)	52.7	27.2	0.1	50.2	23.0	3.5	23.4	26.8		39.4	33.6	6.3
LOS	D	C	A	D	C	A	C	C		D	C	A
Approach Delay (s/veh)		30.3			24.9			25.4			26.6	
Approach LOS		C			C			C			C	
Queue Length 50th (ft)	63	226	0	133	257	0	23	24		175	40	15
Queue Length 95th (ft)	#108	282	0	188	308	55	48	67		255	81	67

Lanes and Geometrics

3: Downers Drive & Butterfield Road

11/24/2025



Lane Group	EBL	EBT	EBR	WBL	WBT	WBR	NBL	NBT	NBR	SBL	SBT	SBR
Internal Link Dist (ft)		887			746			654			391	
Turn Bay Length (ft)	230		280	350		335						150
Base Capacity (vph)	325	2079	743	584	2417	932	366	276		455	399	709
Starvation Cap Reductn	0	0	0	0	0	0	0	0		0	0	0
Spillback Cap Reductn	0	0	0	0	0	0	0	0		0	0	0
Storage Cap Reductn	0	0	0	0	0	0	0	0		0	0	0
Reduced v/c Ratio	0.61	0.56	0.04	0.73	0.57	0.41	0.15	0.29		0.76	0.19	0.34

Intersection Summary

Area Type: Other
 Cycle Length: 100
 Actuated Cycle Length: 100
 Offset: 0 (0%), Referenced to phase 2:EBT and 6:WBT, Start of Green
 Natural Cycle: 60
 Control Type: Actuated-Coordinated
 Maximum v/c Ratio: 0.77
 Intersection Signal Delay (s/veh): 26.9 Intersection LOS: C
 Intersection Capacity Utilization 72.3% ICU Level of Service C
 Analysis Period (min) 15
 # 95th percentile volume exceeds capacity, queue may be longer.
 Queue shown is maximum after two cycles.

Splits and Phases: 3: Downers Drive & Butterfield Road

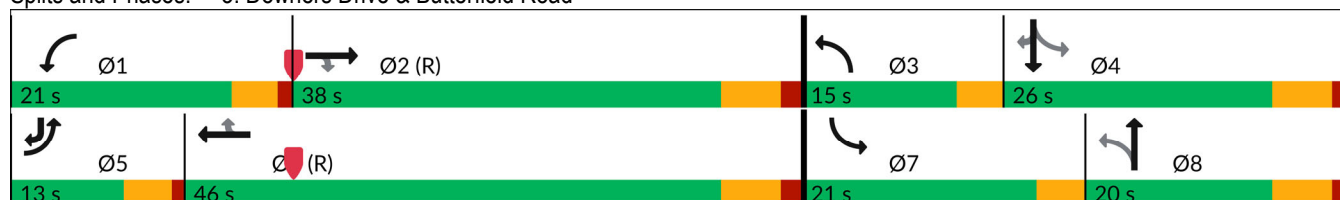

Lanes and Geometrics

8: Downers Drive & Access Road

11/24/2025



Lane Group	EBL	EBT	EBR	WBL	WBT	WBR	NBL	NBT	NBR	SBL	SBT	SBR
Lane Configurations		↕	↗	↖	↘			↕			↕	
Traffic Volume (vph)	5	97	315	336	74	20	358	7	248	8	7	6
Future Volume (vph)	5	97	315	336	74	20	358	7	248	8	7	6
Ideal Flow (vphp)	1900	1900	1900	1900	1900	1900	1900	1900	1900	1900	1900	1900
Storage Length (ft)	0		40	0		0	0		0	0		0
Storage Lanes	0		1	1		0	0		0	0		0
Taper Length (ft)	25			25			25			25		
Lane Util. Factor	1.00	1.00	1.00	1.00	1.00	1.00	0.95	0.95	0.95	0.95	0.95	0.95
Frt			0.850		0.968			0.939			0.957	
Flt Protected		0.998		0.950				0.972			0.981	
Satd. Flow (prot)	0	1896	1615	1805	1839	0	0	3286	0	0	3081	0
Flt Permitted		0.987		0.689				0.790			0.817	
Satd. Flow (perm)	0	1875	1615	1309	1839	0	0	2671	0	0	2566	0
Right Turn on Red			Yes			Yes			Yes			Yes
Satd. Flow (RTOR)			328		21			258			6	
Link Speed (mph)		20			20			25			25	
Link Distance (ft)		252			487			471			398	
Travel Time (s)		8.6			16.6			12.8			10.9	
Peak Hour Factor	0.96	0.96	0.96	0.96	0.96	0.96	0.96	0.96	0.96	0.96	0.96	0.96
Heavy Vehicles (%)	0%	0%	0%	0%	0%	0%	0%	25%	0%	0%	30%	0%
Shared Lane Traffic (%)												
Lane Group Flow (vph)	0	106	328	350	98	0	0	638	0	0	21	0
Turn Type	Perm	NA	Perm	Perm	NA		Perm	NA		Perm	NA	
Protected Phases		4			8			2			6	
Permitted Phases	4		4	8			2			6		
Detector Phase	4	4	4	8	8		2	2		6	6	
Switch Phase												
Minimum Initial (s)	8.0	8.0	8.0	5.0	5.0		8.0	8.0		8.0	8.0	
Minimum Split (s)	14.0	14.0	14.0	14.0	14.0		14.0	14.0		14.0	14.0	
Total Split (s)	20.0	20.0	20.0	20.0	20.0		40.0	40.0		40.0	40.0	
Total Split (%)	33.3%	33.3%	33.3%	33.3%	33.3%		66.7%	66.7%		66.7%	66.7%	
Yellow Time (s)	4.5	4.5	4.5	4.5	4.5		4.5	4.5		4.5	4.5	
All-Red Time (s)	1.5	1.5	1.5	1.5	1.5		1.5	1.5		1.5	1.5	
Lost Time Adjust (s)		0.0	0.0	0.0	0.0			0.0			0.0	
Total Lost Time (s)		6.0	6.0	6.0	6.0			6.0			6.0	
Lead/Lag												
Lead-Lag Optimize?												
Recall Mode	None	None	None	None	None		Min	Min		Min	Min	
Act Effct Green (s)		14.4	14.4	14.4	14.4			18.5			18.5	
Actuated g/C Ratio		0.32	0.32	0.32	0.32			0.41			0.41	
v/c Ratio		0.18	0.45	0.84	0.16			0.51			0.02	
Control Delay (s/veh)		15.3	4.9	41.0	12.9			6.6			5.7	
Queue Delay		0.0	0.0	0.0	0.0			0.0			0.0	
Total Delay (s/veh)		15.3	4.9	41.0	12.9			6.6			5.7	
LOS		B	A	D	B			A			A	
Approach Delay (s/veh)		7.4			34.9			6.6			5.7	
Approach LOS		A			C			A			A	
Queue Length 50th (ft)		19	0	79	13			38			1	
Queue Length 95th (ft)		65	54	#286	54			69			6	

Lanes and Geometrics

8: Downers Drive & Access Road

11/24/2025



Lane Group	EBL	EBT	EBR	WBL	WBT	WBR	NBL	NBT	NBR	SBL	SBT	SBR
Internal Link Dist (ft)		172			407			391			318	
Turn Bay Length (ft)			40									
Base Capacity (vph)		597	737	417	600			2124			1986	
Starvation Cap Reductn		0	0	0	0			0			0	
Spillback Cap Reductn		0	0	0	0			0			0	
Storage Cap Reductn		0	0	0	0			0			0	
Reduced v/c Ratio		0.18	0.45	0.84	0.16			0.30			0.01	

Intersection Summary

Area Type:	Other
Cycle Length:	60
Actuated Cycle Length:	45.3
Natural Cycle:	40
Control Type:	Actuated-Uncoordinated
Maximum v/c Ratio:	0.84
Intersection Signal Delay (s/veh):	15.0
Intersection LOS:	B
Intersection Capacity Utilization:	61.8%
ICU Level of Service:	B
Analysis Period (min):	15
# 95th percentile volume exceeds capacity, queue may be longer.	
Queue shown is maximum after two cycles.	

Splits and Phases: 8: Downers Drive & Access Road



HCM 7th TWSC

7: Butterfield Road & Right-I/Right-Out Access Drive

11/24/2025

Intersection						
Int Delay, s/veh	0.8					
Movement	EBL	EBT	WBT	WBR	SBL	SBR
Lane Configurations		↑↑	↑↑↑			↑
Traffic Vol, veh/h	0	1527	2085	192	0	81
Future Vol, veh/h	0	1527	2085	192	0	81
Conflicting Peds, #/hr	0	0	0	0	0	0
Sign Control	Free	Free	Free	Free	Stop	Stop
RT Channelized	-	None	-	Free	-	Stop
Storage Length	-	-	-	-	-	0
Veh in Median Storage, #	-	0	0	-	0	-
Grade, %	-	0	0	-	0	-
Peak Hour Factor	99	99	99	99	99	99
Heavy Vehicles, %	0	1	1	1	0	0
Mvmt Flow	0	1542	2106	194	0	82

Major/Minor	Major1	Major2	Minor2
Conflicting Flow All	-	0	- 0 - 1053
Stage 1	-	-	- - -
Stage 2	-	-	- - -
Critical Hdwy	-	-	- - 7.1
Critical Hdwy Stg 1	-	-	- - -
Critical Hdwy Stg 2	-	-	- - -
Follow-up Hdwy	-	-	- - 3.9
Pot Cap-1 Maneuver	0	-	- 0 0 194
Stage 1	0	-	- 0 0 -
Stage 2	0	-	- 0 0 -
Platoon blocked, %	-	-	- - -
Mov Cap-1 Maneuver	-	-	- - 194
Mov Cap-2 Maneuver	-	-	- - -
Stage 1	-	-	- - -
Stage 2	-	-	- - -

Approach	EB	WB	SB
HCM Ctrl Dly, s/v	0	0	36.46
HCM LOS			E

Minor Lane/Major Mvmt	EBT	WBT	SBLn1
Capacity (veh/h)	-	-	194
HCM Lane V/C Ratio	-	-	0.422
HCM Ctrl Dly (s/v)	-	-	36.5
HCM Lane LOS	-	-	E
HCM 95th %tile Q(veh)	-	-	1.9

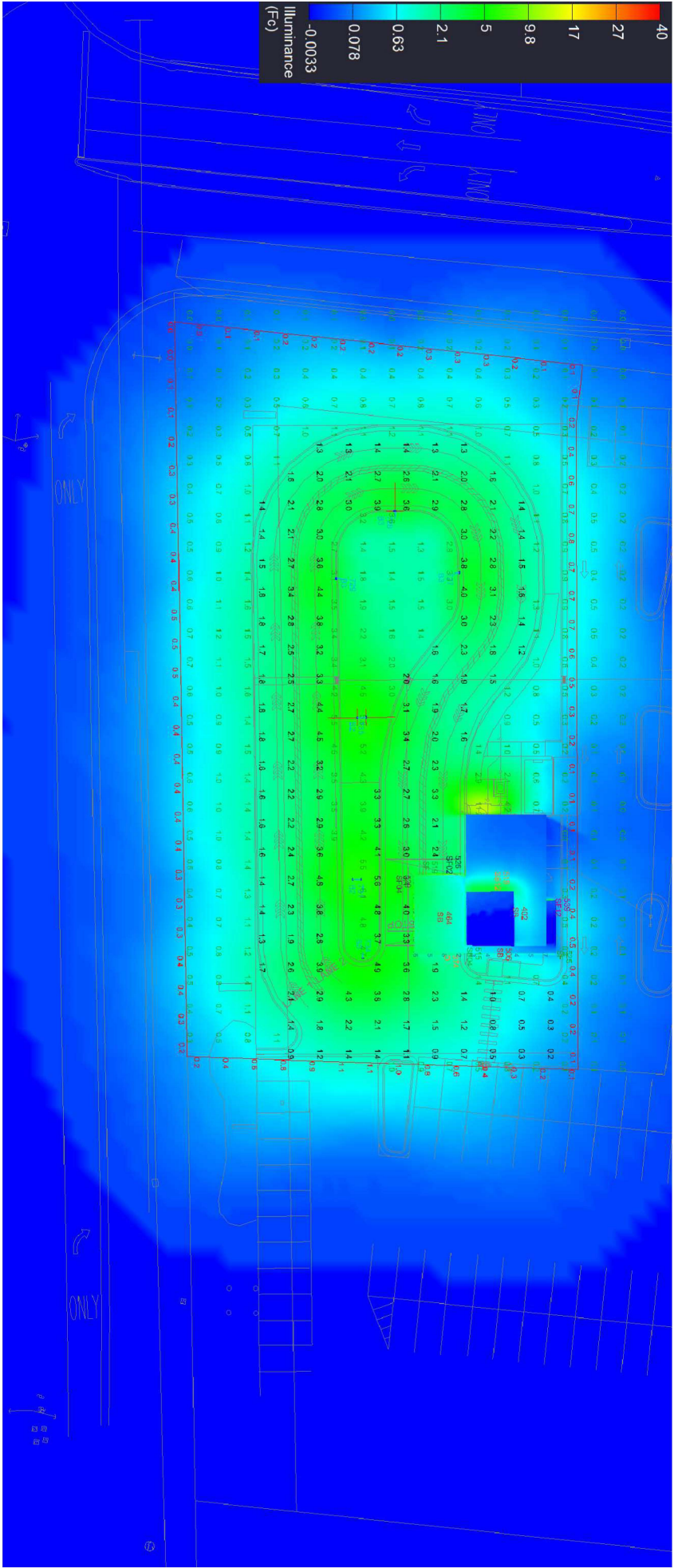
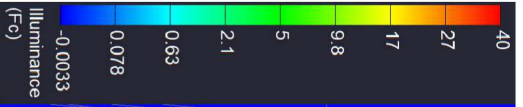

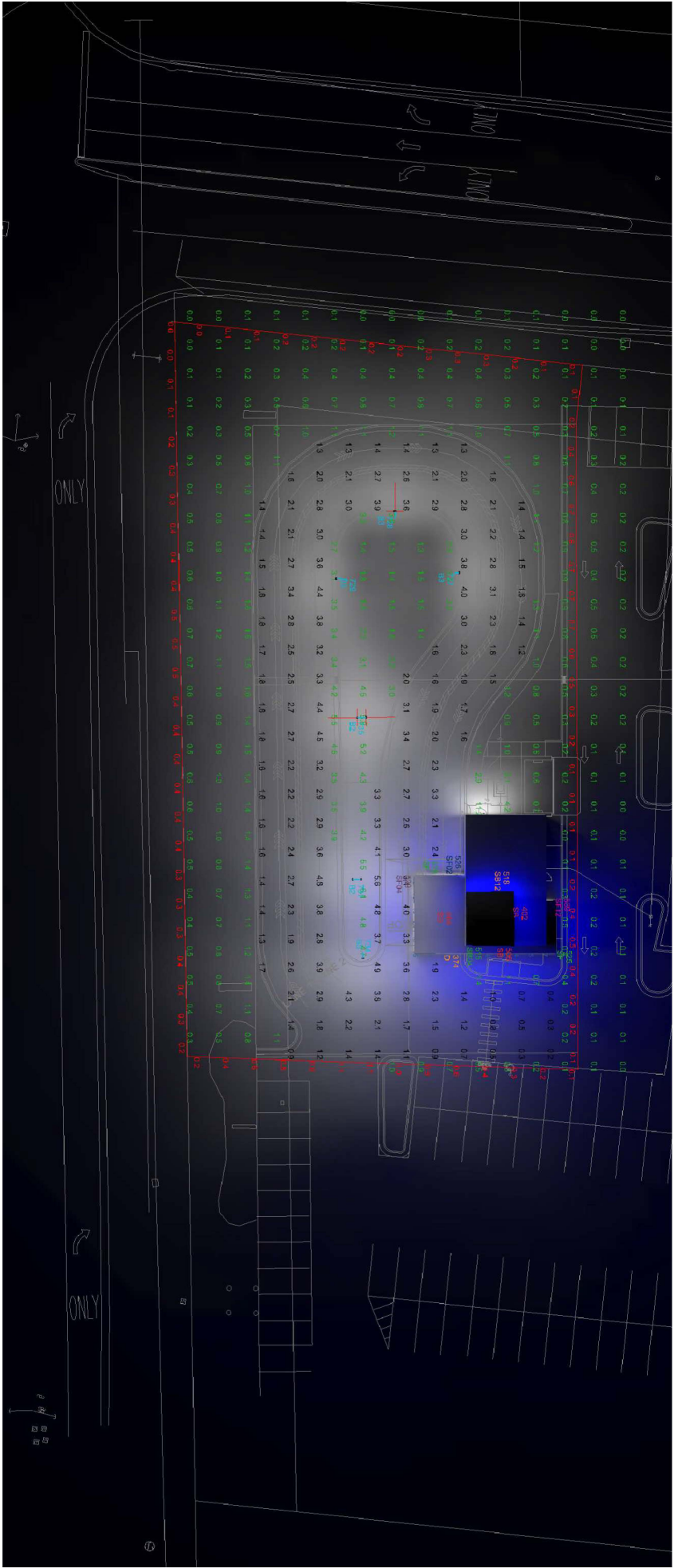

THESE PLANS, SPECIFICATIONS, AND CONDITIONS SHALL BE GOVERNED BY THE STANDARD SPECIFICATIONS FOR ROAD AND BRIDGE CONSTRUCTION, LATEST EDITION, AS ADOPTED BY THE ILLINOIS DEPARTMENT OF TRANSPORTATION. THE CONTRACTOR SHALL BE RESPONSIBLE FOR OBTAINING THE LATEST EDITION OF THE STANDARD SPECIFICATIONS FOR ROAD AND BRIDGE CONSTRUCTION, LATEST EDITION, AS ADOPTED BY THE ILLINOIS DEPARTMENT OF TRANSPORTATION. THE CONTRACTOR SHALL BE RESPONSIBLE FOR OBTAINING THE LATEST EDITION OF THE STANDARD SPECIFICATIONS FOR ROAD AND BRIDGE CONSTRUCTION, LATEST EDITION, AS ADOPTED BY THE ILLINOIS DEPARTMENT OF TRANSPORTATION. THE CONTRACTOR SHALL BE RESPONSIBLE FOR OBTAINING THE LATEST EDITION OF THE STANDARD SPECIFICATIONS FOR ROAD AND BRIDGE CONSTRUCTION, LATEST EDITION, AS ADOPTED BY THE ILLINOIS DEPARTMENT OF TRANSPORTATION.



DRAFT

**VILLAGE OF DOWNERS GROVE
PLANNING AND ZONING COMMISSION****January 5, 2026, 7:00 p.m.**

25-PZC-0034: A PETITION SEEKING A MAP AMENDMENT FROM B-3, GENERAL SERVICES AND HIGHWAY BUSINESS, TO B-3/PUD, GENERAL SERVICES AND HIGHWAY BUSINESS/PLANNED UNIT DEVELOPMENT, A PLANNED UNIT DEVELOPMENT AND A SPECIAL USE FOR A DRIVE-THROUGH. THE PROPERTY IS LOCATED AT THE NORTHEAST CORNER OF THE INTERSECTION OF BUTTERFIELD ROAD AND DOWNERS DRIVE, COMMONLY KNOWN AS 1434 BUTTERFIELD ROAD (PINS 06-304-04-010 AND 06-304-04-011). PETITIONER, SARAH WILKERSON; OWNER, ALPINE INCOME PROPERTY OP.

Laura Pacino spoke on behalf of the petitioner. She works for Who Brew, LLC, the franchisee of 7 Brew. 7 Brew is a double drive-through concept only with no inside or outside dining. Employees walk through the drive-through with iPads. They do not have traditional menu boards. Drinks are not handed out windows. They have sliding glass doors and somebody comes out to the vehicle. Their emphasis is on speed of service and fun, energetic, with music playing. Core demographic is 15 to 25-year-olds. They do not have a line at 7:00 a.m. but may have a line throughout the day during lunchtime, after high school and college and in the evening. Hours of operation are 5:30 to 10:00 Sunday through Thursday and open until 11:00 on Friday and Saturday. A sample menu was shown. They have one food item, a prepackaged muffin top. An aerial photo was shown of the lot and current conditions, along with a site plan. They worked with staff to have the trash enclosure connected to the building to not interfere with additional parking. They also worked with staff to add additional landscape islands on impervious parking lot. The double drive-through lanes can queue 39 cars currently. With the additional stacking plan, they can stack 57 cars. A parking site plan was shown. There are currently 379 parking spots, and it will go down to 320.

Brendan May, with KLOA. He is a professional licensed engineer in the State of Illinois and has a professional traffic operations engineering certification. He stated he has been working with 7 Brew to identify their trip generation and queuing characteristics. The Chicagoland market is more unique than what they are seeing nationwide. There are now seven stands open in the area. The traffic study found that the volume of traffic estimated to be generated by the 7 Brew would have a limited impact on the existing access serving the shopping center. It is anticipated that with the opening of this location, as well as other locations, that the trip generation surveys as conducted would decrease in time, but they are utilized as-is to provide a worst-case scenario. Based on a review of the queuing surveys conducted at the Naperville and Lake Zurich locations, they also looked at sales and ZIP code data compared to other national average locations. They think that a peak queue that a new Chicagoland location could expect is 34 vehicles and the 39-vehicle stacking as proposed would be adequate in accommodating the peak stacking for this site. The 320 parking spaces that serve Best Buy and Golf Galaxy will be adequate in accommodating their parking demand.

Ms. Pacino stated they have a market of four areas, Chicago, Northwest Indiana, Nashville and Pittsburgh with 26 stands open, 12 being in Chicago and Northwest Indiana. The open and under construction locations were named. There are 13 under permit review and 9 under entitlement. Naperville was the first stand they opened. They originally were talking about half-acre sites, 15 to 20 queue spaces, and quickly found out that that does not work in the Chicagoland market. Chicagoland market is the number one market across every market, and Naperville is the number one stand out of 604. They are looking at acre-plus sites and high 30s, low 40s queue counts. Signage and color boards were reviewed. The findings of facts for the PUD, the special use and the map amendment were included.

DRAFT

Chairman Rickard stated that their building pad sits down from the road elevation and asked if they intend to incorporate that height difference and screening of that equipment. Ms. Pacino stated, if it needs to be, yes.

Chairman Rickard asked for any questions for the petitioner.

Commissioner Lincoln asked what happens if a customer is done but the customer in front of them is not done. Ms. Pacino responded that with the drive-through doors they can shuffle around traffic, move somebody up to a waiting area to keep the flow of cars going. The employees go around with iPads, and it is typically a 4 to 5-minute wait time and there is usually not a stagnant of cars waiting to get their drinks.

Commissioner Lincoln further asked what can fit now at Naperville. Mr. May responded 26 before it extends onto the street. One of the limitations of the Naperville site is the orders can only be taken so far in the queue, and at this site the orders can be taken as far as the 39th vehicle. There is an operational benefit to the way the newer sites are laid out that Naperville is still dealing with.

Commissioner Reyes asked regarding how customers will enter the area. Ms. Pacino responded they are going to turn either right or left onto Downers and go to the access point. Mr. May added there is a signal at Downers Drive and the right in, right out access drive on Butterfield Road. You drive through a good bit of the parking lot to get to the location. It is accessed off the parking lot.

Commissioner Frankovic asked if they service pedestrian traffic. Ms. Pacino responded they will service pedestrian traffic and direct them to the non-service side and that is why there is a sidewalk. It is not advertised and not something they typically do but they will not turn a customer away. They will direct them to the safest side to place the order. It was further asked if they have a contingency plan if there is an increase in pedestrian traffic. Ms. Pacino could not speak to that now, but the operations team should be able to answer that. The sidewalk placement directs pedestrians to the north side of the building, the non-service side, and there are sliding doors on that side, and the pedestrians do not have to go across the traffic.

Commissioner Lincoln asked what kind of relief are they requesting with the planned unit development. Staff stated they will cover that in their report. Ms. Pacino stated the PUD is in regards to putting the two buildings on one parcel, which is the Golf Galaxy and 7 Brew. They are not doing a re-subdivision of the plat.

Commissioner Reyes asked how many employees are planned to be on-site during peak hours. Ms. Pacino responded the standard is five.

Chairman Rickard asked for public comment.

Scott Richards stated that he has never heard of this business before and asked whether it was strictly for drinks or if there is food served. He is hesitant about the queuing of up to 39 cars and voiced concern about it being congested. He stated it is a strange business concept.

Chairman Rickard asked for the staff report.

Carter Moran, Planner, gave the staff report. Mr. Moran stated this is a 7.38-acre property located northeast of the intersection of Downers Drive and Butterfield Road. The address consists of two lots of record. It is zoned B-3, general services and highway business. All noticing requirements were met and included mailing notices, notice published in the newspaper of record and posted signs at the location. Staff received no public comment regarding this proposal. At a high-level, the proposed development includes the constructions of the proposed building, canopy and trash enclosure; the installation of the 39 stacking

DRAFT

spaces, along with the 18 overflow stacking spaces extending to the east. There are landscape islands going in at the endcaps of all the existing parking aisles. These were requested by staff to improve pedestrian safety and the circulation of traffic throughout the lot without crossing parking aisles. Renderings were shown. There is no customer access for walk-in orders, therefore no pedestrian connections from nearby public rights-of-way were requested by staff.

Mr. Moran further stated that the PUD items include the construction of the trash enclosure in the street yard between the proposed building and Downers Drive; reduction of the total number of parking stalls serving the shopping center, which would be 320, which does meet a requirement of 4 per 1,000 square feet of tenant space for a shopping center; and the building of two primary structure on one lot of record. The traffic and parking study was briefly reviewed.

Mr. Carter then stated that the proposal accomplishes the goals of the comprehensive plan by promoting out-lot development along Butterfield Road and repurposing parking lots to meet changing retail conditions. The site's location close to major highways makes it an appropriate site. Regarding land use, there are fewer concerns about increased traffic in residential areas and takes advantage of its location along two major highways. Lastly, he stated that based on the petitioner's proposed development with staff revisions, staff recommends approval of the proposed PUD, special use and map amendment. Slides were shown of the review criteria of the three entitlement items requested by the petitioner.

Chairman Rickard asked if there were questions for staff.

Commissioner Lincoln asked, in a similar situation with a big box store and an out-lot, if it would require a PUD. Staff responded it is more than just the subdivided out-lot. Deviations were also being requested for the parking. The second building on one lot is another trigger for the PUD. Commissioner Lincoln clarified that there really is no other place to put the trash and that that is why the PUD is required.

Chairman Rickard confirmed that the existing pavement lines are existing nonconformities that are being noted and there is no change as a result of this application. The placement of the dumpster was discussed. The reduction in shopping center parking spaces, Chairman Rickard asked staff if those parking lots are generally overparked to begin with and that that asphalt is vacant a majority of the time. Staff's response was inaudible.

Chairman Rickard asked for last comments from the petitioner. Petitioner declined.

Chairman Rickard asked the Commissioners for discussion or comments.

Commissioner Patel stated he is supportive and the design has been thoughtfully put together with a lot of intention with queuing stacking and other challenges at other locations. He feels comfortable that it is enclosed within the parking lot site and thinks the standards have been met.

Commissioner Frankovic stated that, having seen the Naperville location at its peak, she was concerned about how this was going to fit into the village, but states this is probably the best possible location for this business in the village. She thinks the plan is very well thought out. She reiterated her concern about pedestrians but understands it is mainly a drive-through business. She feels all the standards for approval have been met.

Commissioner Lincoln agrees with Commissioner Frankovic with it being in the parking lot and the location. He is not really concerned with the PUD and trash enclosure. He is happy to see the decrease in impervious area and glad to hear there are some deliberative steps on behalf of the village to change their parking regulations. They are oversaturated with parking in all the business districts and this is a great reuse

DRAFT

of area. They have talked about many different ways they are going to reduce the impact. He is in favor of approval.

Chairman Rickard stated he thinks the layout works well. If the queue line backs up beyond what is shown, it backs up into a dead part of the parking lot and not into a street or drive aisle that will cause any issues. He likes the location of the dumpster. Regarding the special permit for the drive-through window, it is not near a residential area, and it is kind of isolated down in a hole, and noise from an order board or headlights shining are not a concern. He supports it.

BASED ON THE PETITIONER'S SUBMITTAL, THE STAFF REPORT AND THE TESTIMONY PRESENTED, IT IS FOUND THAT THE PETITIONER HAS MET THE STANDARDS OF APPROVAL OF A PLANNED UNIT DEVELOPMENT, A MAP AMENDMENT FROM B-3 GENERAL SERVICE AND HIGHWAY BUSINESS TO B-3/PUD, GENERAL SERVICES AND HIGHWAY BUSINESS PLANNED UNIT DEVELOPMENT AND A SPECIAL USE TO CONSTRUCTION AND OPERATE A DRIVE-THROUGH RESTAURANT AS REQUIRED BY THE VILLAGE OF DOWNERS GROVE ZONING ORDINANCE AND IT IS IN THE PUBLIC INTEREST, AND THEREFORE, COMMISSIONER LINCOLN MADE A MOTION THAT THE PLANNING AND ZONING COMMISSION RECOMMEND TO THE VILLAGE COUNCIL APPROVAL OF 25-PZC-0034, SUBJECT TO THE CONDITIONS AS OUTLINED IN THE STAFF REPORT NUMBERED 1 AND 2.

SECOND BY COMMISSIONER FRANKOVIC

ROLL CALL:

AYE: PATEL, LINCOLN, FRANKOVIC, REYES, WOLF, CHAIRMAN RICKARD

MOTION APPROVED. VOTE 6-0

/s/

Recording Secretary

(As transcribed by Ditto Transcripts)