



Village of Downers Grove

Report for the Village Council Meeting

Table 1 - Council Agenda item.

Subject	Purchase of Firefighter Self Contained Breathing Apparatus (SCBA)
Submitted By	Scott Spinazola, Fire Chief

Synopsis

A motion is requested to authorize a contract in an amount not to exceed \$520,000 with Air One, Inc. for the purchase of self-contained breathing apparatuses (SCBA).

Strategic Plan Alignment

Goals for 2025-2027 include Excellent Municipal Services.

Fiscal Impact

The FY26 budget includes \$520,000 in the Equipment Replacement Fund for this purchase.

Recommendation

Approval on the May 19, 2026 consent agenda.

Background

Replacement of SCBA and fit testing equipment is an essential purchase to sustain the operations of the Fire Department. The equipment being replaced is at the end

of its service life due to age, wear and noncompliance with current safety standards.

A Request for Proposals was issued on January 26, 2026. Proposals were received from Air One Equipment for the MSA G1XR NFPA 1970, 2025 Edition (\$534,585.00) and from Municipal Emergency Service Company for the Scott Air Pak X3 Pro (\$614,260.00). The products proposed by Municipal Emergency Service Company do not meet the current National Fire Protection Association standard. Air One Equipment has proposed a credit of \$25,900.00 for the current inventory of SCBA, which brings the total contract cost down to \$508,685. Staff requests authority for additional funding related to this purchase in the event the credit amount is reduced as a result of credited equipment being rejected by Air One.

The Fire Department has used the MSA G1 SCBA since 2016 and has found them to be reliable in all aspects. Air One, Inc. has provided excellent customer service and product support.

Attachments

Agreement



Village of Downers Grove

Council Action Summary

Table 1 - Council Action Summary.

Initiated By	Fire Department
Effective Date	May 19, 2026
Recommendation From	
File Reference	
Nature of Action	Motion

Steps Needed to Implement Action.

Motion to authorize a contract for the purchase of self-contained breathing apparatuses (SCBA)s in the amount of \$508,685 with a contingency in the amount of \$11,315 for a total not to exceed \$520,000.

Summary of Item.

Adoption of this motion shall authorize execution of a contract for the purchase of self-contained breathing apparatuses (SCBA)s in the amount of \$508,685 with a contingency in the amount of \$11,315 for a total not to exceed \$520,000.

Record of Action Taken.



REQUEST FOR PROPOSAL

Name of Proposing Company: Air One Equipment, Inc.

Project Name: **SCBA Equipment**
Proposal No.: RFP-012625-0-2026/MT
Proposal Due: February 19, 2026 10:00AM

Required of All Proposers:

Deposit: No
Letter of Capability of Acquiring Performance Bond: No

Required of Awarded Contractor:

Performance Bond/Letter of Credit: No
Certificate of Insurance: Yes

Legal Advertisement Published: January 26, 2026 4:30PM
Date Issued: January 26, 2026
This document consists of 24 pages.

Return **original** and **two duplicate copies** of proposal in a **sealed envelope** marked with the Proposal Number as noted above to:

Matt Timmerberg
Assistant to the Village Manager
VILLAGE OF DOWNERS GROVE
850 CURTISS STREET
DOWNERS GROVE, IL 60515
mtimmerberg@downers.us
www.downers.us

The VILLAGE OF DOWNERS GROVE will receive proposals Monday thru Friday, 7:30 A.M. to 4:30 P.M. at the Civic Center, 850 Curtiss Street, Downers Grove, IL 60515.

SPECIFICATIONS MUST BE MET AT THE TIME THE PROPOSAL IS DUE.

The Village Council reserves the right to accept or reject any and all Proposals, to waive technicalities and to accept or reject any item of any Proposal.

The documents constituting component parts of this contract are the following:

- I. REQUEST FOR PROPOSALS
- II. TERMS & CONDITIONS
- III. DETAILED SPECIFICATIONS
- IV. PROPOSER'S RESPONSE TO RFP
- V. PROPOSAL/CONTRACT FORM

DO NOT DETACH ANY PORTION OF THIS DOCUMENT. INVALIDATION COULD RESULT. Proposers MUST submit an original, and 2 additional paper copies of the total Proposal. Upon formal award of the Proposal, the successful Proposer will receive a copy of the executed contract.

I. REQUEST FOR PROPOSALS

1. GENERAL

- 1.1 Notice is hereby given that the Village of Downers Grove will receive sealed Proposals up to THE TIME AND DATE SET FORTH ON THE COVER PAGE OF THIS REQUEST FOR PROPOSALS.
- 1.2 Proposals must be received at the Village of Downers Grove by the time and date specified. Proposals received after the specified time and date will not be accepted and will be returned unopened to the Proposer.
- 1.3 Proposal forms shall be sent to the Village of Downers Grove, ATTN: Matt Timmerberg, Assistant to the Village Manager in a sealed envelope marked "SEALED PROPOSAL". The envelope shall be marked with the name of the project, date, and time set for receipt of Proposals.
- 1.4 All Proposals must be submitted on the forms supplied by the Village and signed by a proper official of the company submitting the Proposal. Telephone, email and fax proposals will not be accepted.
- 1.5 By submitting this Proposal, the Proposer certifies under penalty of perjury that they have not acted in collusion with any other Proposer or potential Proposer.

2. PREPARATION OF PROPOSAL

- 2.1 It is the responsibility of the Proposer to carefully examine the specifications and proposal documents and to be familiar with all of the requirements, stipulations, provisions, and conditions surrounding the proposed services.
- 2.2 No oral or telephone interpretations of specifications shall be binding upon the Village. All requests for interpretations or clarifications shall be made in writing and received by the Village at least five (5) business days prior to the date set for receipt of Proposals. All changes or interpretations of the specifications shall be made by the Village in a written addendum to the Village's proposers of record.
- 2.3 In case of error in the extension of prices in the Proposal, the hourly rate or unit price will govern. In case of discrepancy in the price between the written and numerical amounts, the written amount will govern.
- 2.4 All costs incurred in the preparation, submission, and/or presentation of any Proposal including any Proposer's travel or personal expenses shall be the sole responsibility of the Proposer and will not be reimbursed by the Village.
- 2.5 The Proposer hereby affirms and states that the prices quoted herein constitute the total cost to the Village for all work involved in the respective items and that this cost also includes all insurance, bonds, royalties, transportation charges, use of all tools and equipment, superintendence, overhead expense, all profits and all other work, services and conditions necessarily involved in the work to be done and materials to be furnished in accordance

with the requirements of the Contract Documents considered severally and collectively.

3. **PRE- PROPOSAL CONFERENCE**

- 3.1 A preproposal conference may be offered to provide additional information, inspection or review of current facilities or equipment, and to provide an open forum for questions from Proposers. This preproposal conference is not mandatory (unless stated "Required" on the cover of this document), but attendance by Proposers is strongly advised as this will be the last opportunity to ask questions concerning the Proposal.
- 3.2 Questions may be posed in writing to the Village (faxed and emailed questions are acceptable), but must be received by the Village prior to the scheduled time for the pre-proposal conference. Questions received will be considered at the conference. An addendum may be issued as a result of the preproposal conference. Such an addendum is subject to the provisions for issuance of an addendum as set forth in Section 2.2 above.

4. **MODIFICATION OR WITHDRAWAL OF PROPOSALS**

- 4.1 A Proposal that is in the possession of the Village may be altered by a letter bearing the signature or name of the person authorized for submitting a Proposal, provided that it is received prior to the time and date set for the Proposal opening. Telephone, email or verbal alterations of a Proposal will not be accepted.
- 4.2 A Proposal that is in the possession of the Village may be withdrawn by the Proposer, up to the time set for the Proposal opening, by a letter bearing the signature or name of the person authorized for submitting Proposals. Proposals may not be withdrawn after the Proposal opening and shall remain valid for a period of ninety (90) days from the date set for the Proposal opening, unless otherwise specified.

5. **SECURITY FOR PERFORMANCE**

- 5.1 The awarded contractor, within thirteen (13) calendar days after acceptance of the Proposer's Proposal by the Village, shall furnish security for performance acceptable to the Village when required under the documents. Such security shall be either a satisfactory performance bond (bonding company must be licensed to do business in Illinois) or a letter of credit on the form provided by the Village and available from the Village's Purchasing Manager. Any bond shall include a provision as will guarantee faithful performance of the Illinois Prevailing Wage Act, 820 ILCS 130/1 et seq. **NOTE: As evidence of capability to provide such security for performance, each Proposer shall submit with the Proposal either a letter executed by its surety company indicating the Proposer's performance bonding capability, or a letter from a bank or savings and loan within twenty-five miles of the corporate boundaries of the Village indicating its willingness and intent to provide a letter of credit for the Proposer.**

6. **DELIVERY**

- 6.1 All proposal prices are to be quoted, delivered F.O.B. Village of Downers Grove, 801 Burlington, Downers Grove, IL 60515.

7. **TAX EXEMPTION**

- 7.1 The Village is exempt from Illinois sales or use tax for direct purchases of materials and supplies. A copy of the Illinois Sales Tax Exemption Form will be issued upon request. The Village's federal identification will also be provided to selected vendor.

8. RESERVED RIGHTS

- 8.1 The Village reserves the exclusive right to waive sections, technicalities, irregularities and informalities and to accept or reject any and all Proposals and to disapprove of any and all subcontractors as may be in the best interest of the Village. Time and date requirements for receipt of Proposals will not be waived.

II. TERMS AND CONDITIONS

9. VILLAGE ORDINANCES

- 9.1 The successful Proposer will strictly comply with all ordinances of the Village of Downers Grove and laws of the State of Illinois.

10 USE OF VILLAGE'S NAME

- 10.1 The Proposer is specifically denied the right of using in any form or medium the name of the Village for public advertising unless express permission is granted by the Village.

11. SPECIAL HANDLING

- 11.1 Prior to delivery of any product which is caustic, corrosive, flammable or dangerous to handle, the Proposer will provide written directions as to methods of handling such products, as well as the antidote or neutralizing material required for its first aid before delivery. Proposer shall also notify the Village and provide material safety data sheets for all substances used in connection with this Contract which are defined as toxic under the Illinois Toxic Substances Disclosure to Employees Act.

12. INDEMNITY AND HOLD HARMLESS AGREEMENT

- 12.1 To the fullest extent permitted by law, the Proposer shall indemnify, keep and save harmless the Village and its agents, officers, and employees, against all injuries, deaths, losses, damages, claims, suits, liabilities, judgments, costs and expenses, which may arise directly or indirectly from any negligence or from the reckless or willful misconduct of the Proposer, its employees, or its subcontractors, and the Proposer shall at its own expense, appear, defend and pay all charges of attorneys and all costs and other expenses arising therefrom or incurred in connection therewith, and, if any judgment shall be rendered against the Village in any such action, the Proposer shall, at its own expense, satisfy and discharge the same. This agreement shall not be construed as requiring the Proposer to indemnify the Village for its own negligence. The Proposer shall indemnify, keep and save harmless the Village only where a loss was caused by the negligent, willful or reckless acts or omissions of the Proposer, its employees, or its subcontractors.

13. NONDISCRIMINATION

- 13.1 Proposer shall, as a party to a public contract:

- (a) Refrain from unlawful discrimination in employment and undertake affirmative action to assure equality of employment opportunity and eliminate the effects of past discrimination;
 - (b) By submission of this Proposal, the Proposer certifies that it is an "equal opportunity employer" as defined by Section 2000(e) of Chapter 21, Title 42, U.S. Code Annotated and Executive Orders #11246 and #11375, which are incorporated herein by reference. The Equal Opportunity clause, Section 6.1 of the Rules and Regulations of the Department of Human Rights of the State of Illinois, is a material part of any contract awarded on the basis of this Proposal.
- 13.2 It is unlawful to discriminate on the basis of race, color, religion, sex, marital status, national origin or ancestry, age, physical or mental disability unrelated to ability, military status, order of protection status, sexual orientation, sexual identity, or an unfavorable discharge from military service. Proposer shall comply with standards set forth in Title VII of the Civil Rights Act of 1964, 42 U.S.C. Sec. 2000 *et seq.*, The Human Rights Act of the State of Illinois, 775 ILCS 5/1-101 *et seq.*, and The Americans with Disabilities Act, 42 U.S.C. Sec. 12101 *et seq.*

14. SEXUAL HARASSMENT POLICY

- 14.1 The Proposer, as a party to a public contract, shall have a written sexual harassment policy that:
- 14.1.1 Notes the illegality of sexual harassment;
 - 14.1.2 Sets forth the State law definition of sexual harassment;
 - 14.1.3 Describes sexual harassment utilizing examples;
 - 14.1.4 Describes the Proposer's internal complaint process including penalties;
 - 14.1.5 Describes the legal recourse, investigative and complaint process available through the Illinois Department of Human Rights and the Human Rights Commission and how to contact these entities; and
 - 14.1.6 Describes the protection against retaliation afforded under the Illinois Human Rights Act.

15. EQUAL EMPLOYMENT OPPORTUNITY

- 15.1 In the event of the Proposer's non-compliance with the provisions of this Equal Employment Opportunity Clause, the Illinois Human Rights Act or the Rules and Regulations of the Illinois Department of Human Rights ("Department"), the Proposer may be declared ineligible for future contracts or subcontracts with the State of Illinois or any of its political subdivisions or municipal corporations, and the contract may be canceled or voided in whole or in part, and such other sanctions or penalties may be imposed or remedies invoked as provided by statute or regulation. During the performance of this Contract, the Proposer agrees as follows:
- 15.1.1 That it will not discriminate against any employee or applicant for employment because of race, color, religion, sex, marital status, national origin or ancestry, age, physical or mental disability unrelated to ability, military status, order of protection

status, sexual orientation, sexual identity or an unfavorable discharge from military service; and further that it will examine all job classifications to determine if minority persons or women are underutilized and will take appropriate affirmative action to rectify any such underutilization.

- 15.1.2 That, if it hires additional employees in order to perform this Contract or any portion thereof, it will determine the availability (in accordance with the Department's Rules and Regulations) of minorities and women in the area(s) from which it may reasonably recruit and it will hire for each job classification for which employees are hired in such a way that minorities and women are not underutilized.
- 15.1.3 That, in all solicitations or advertisements for employees placed by it or on its behalf, it will state that all applicants will be afforded equal opportunity without discrimination because of race, color, religion, sex, marital status, national origin or ancestry, age, physical or mental disability unrelated to ability, military status, order of protection status, sexual orientation, or an unfavorable discharge from military services.
- 15.1.4 That it will send to each labor organization or representative of workers with which it has or is bound by a collective bargaining or other agreement or understanding, a notice advising such labor organization or representative of the Proposer's obligations under the Illinois Human Rights Act and the Department's Rules and Regulations. If any such labor organization or representative fails or refuses to cooperate with the Proposer in its efforts to comply with such Act and Rules and Regulations, the Proposer will promptly so notify the Department and the contracting agency and will recruit employees from other sources when necessary to fulfill its obligations thereunder.
- 15.1.5 That it will submit reports as required by the Department's Rules and Regulations, furnish all relevant information as may from time to time be requested by the Department or the contracting agency, and in all respects comply with the Illinois Human Rights Act and the Department's Rules and Regulations.
- 15.1.6 That it will permit access to all relevant books, records, accounts and work sites by personnel of the contracting agency and the Department for purpose of investigation to ascertain compliance with the Illinois Human Rights Act and the Department's Rules and Regulations.
- 15.1.7 That it will include verbatim or by reference the provisions of this clause in every subcontract it awards under which any portion of the contract obligations are undertaken or assumed, so that such provisions will be binding upon such subcontractor. In the same manner as with other provisions of this Contract, the Proposer will be liable for compliance with applicable provisions of this clause by such subcontractors; and further it will promptly notify the contracting agency and the Department in the event any subcontractor fails or refuses to comply therewith. In addition, the Proposer will not utilize any subcontractor declared by the Illinois Human Rights Commission to be ineligible for contracts or subcontracts with the

State of Illinois or any of its political subdivisions or municipal corporations.

16. DRUG FREE WORK PLACE

Proposer, as a party to a public contract, certifies and agrees that it will provide a drug free workplace by:

- 16.1 Publishing a statement: (1) Notifying employees that the unlawful manufacture, distribution, dispensation, possession or use of a controlled substance, including cannabis, is prohibited in the Village's or Proposer's workplace. (2) Specifying the actions that will be taken against employees for violations of such prohibition. (3) Notifying the employee that, as a condition of employment on such contract or grant, the employee will: (A) abide by the terms of the statement; and (B) notify the employer of any criminal drug statute conviction for a violation occurring in the workplace no later than five (5) days after such conviction.
- 16.2 Establishing a drug free awareness program to inform employees about: (1) the dangers of drug abuse in the workplace; (2) the Village's or Proposer's policy of maintaining a drug free workplace; (3) any available drug counseling, rehabilitation and employee assistance programs; (4) the penalties that may be imposed upon employees for drug violations.
- 16.3 Providing a copy of the statement required above to each employee engaged in the performance of the contract or grant and to post the statement in a prominent place in the workplace.
- 16.4 Notifying the contracting or granting agency within ten (10) days after receiving notice of any criminal drug statute conviction for a violation occurring in the workplace from an employee or otherwise receiving actual notice of such conviction.
- 16.5 Imposing a sanction on, or requiring the satisfactory participation in a drug abuse assistance or rehabilitation program by, any employee who is so convicted as required by section 5 of the Drug Free Workplace Act.
- 16.6 Assisting employees in selecting a course of action in the event drug counseling, treatment and rehabilitation is required and indicating that a trained referral team is in place.
- 16.7 Making a good faith effort to continue to maintain a drug free workplace through implementation of the Drug Free Workplace Act.

17. PATRIOT ACT COMPLIANCE

- 17.1 The Proposer represents and warrants to the Village that neither it nor any of its principals, shareholders, members, partners, or affiliates, as applicable, is a person or entity named as a Specially Designated National and Blocked Person (as defined in Presidential Executive Order 13224) and that it is not acting, directly or indirectly, for or on behalf of a Specially Designated National and Blocked Person. The Proposer further represents and warrants to the Village that the Proposer and its principals, shareholders, members, partners, or affiliates, as applicable are not, directly or indirectly, engaged in, and are not facilitating, the transactions contemplated by this Contract on behalf of any person or entity named as

a Specially Designated National and Blocked Person. The Proposer hereby agrees to defend, indemnify and hold harmless the Village, and its elected or appointed officers, employees, agents, representatives, engineers and attorneys, from and against any and all claims, damages, losses, risks, liabilities and expenses (including reasonable attorney's fees and costs) arising from or related to any breach of the foregoing representations and warranties.

18. INSURANCE REQUIREMENTS

- 18.1 Prior to starting the work, Contractor and any Subcontractors shall procure, maintain and pay for such insurance as will protect against claims for bodily injury or death, or for damage to property, including loss of use, which may arise out of operations by the Contractor or Subcontractor or any Sub-Sub Contractor or by anyone employed by any of them, or by anyone for whose acts any of them may be liable. Such insurance shall not be less than the greater of coverages and limits of liability specified below or any coverages and limits of liability specified in the Contract Documents or coverages and limits required by law unless otherwise agreed to by the Village.

Workers Compensation	\$500,000	Statutory
Employers Liability	\$1,000,000	Each Accident
	\$1,000,000	Disease Policy Limit
	\$1,000,000	Disease Each Employee
Comprehensive General Liability	\$2,000,000	Each Occurrence
	\$2,000,000	Aggregate
		<i>(Applicable on a Per Project Basis)</i>
Commercial Automobile Liability	\$1,000,000	Each Accident
Professional Errors & Omissions	\$2,000,000	Each Claim
(pursuant to section .9 below)	\$2,000,000	Annual Aggregate
Umbrella Liability	\$ 5,000,000	

- 18.2 Commercial General Liability Insurance required under this paragraph shall be written on an occurrence form and shall include coverage for Products/Completed Operations, Personal Injury with Employment Exclusion (if any) deleted, Blanket XCU and Blanket Contractual Liability insurance applicable to defense and indemnity obligations and other contractual indemnity assumed under the Contract Documents. The limit must be on a "Per Project Basis".
- 18.3 Comprehensive Automobile Liability Insurance required under this paragraph shall include coverage for all owned, hired and non-owned automobiles.

- 18.4 Workers Compensation coverage shall include a waiver of subrogation against the Village.
- 18.5 Comprehensive General Liability, Employers Liability and Commercial Automobile Liability Insurance may be arranged under single policies for full minimum limits required, **or** by a combination of underlying policies with the balance provided by Umbrella and/or Excess Liability policies.
- 18.6 Contractor and all Subcontractors shall have their respective Comprehensive General Liability (including products/completed operations coverage), Employers Liability, Commercial Automobile Liability, and Umbrella/Excess Liability policies endorsed to add the "Village of Downers Grove, its officers, officials, employees and volunteers" as "additional insureds" with respect to liability arising out of operations performed; claims for bodily injury or death brought against the Village by any Contractor or Subcontractor employees, or the employees of Subcontractor's subcontractors of any tier, however caused, related to the performance of operations under the Contract Documents. Such insurance afforded to the Village shall be endorsed to provide that the insurance provided under each policy shall be **Primary and Non-Contributory**.
- 18.7 Contractor and all Subcontractors shall maintain in effect all insurance coverages required by the Contract Documents at their sole expense and with insurance carriers licensed to do business in the State of Illinois and having a current A. M. Best rating of no less than A-VIII. In the event that the Contractor or any Subcontractor fails to procure or maintain any insurance required by the Contract Documents, the Village may, at its option, purchase such coverage and deduct the cost thereof from any monies due to the Contractor or Subcontractor, or withhold funds in an amount sufficient to protect the Village, or terminate this Contract pursuant to its terms.
- 18.8 All insurance policies shall contain a provision that coverages and limits afforded hereunder shall not be canceled, materially changed, non-renewed or restrictive modifications added, without thirty (30) days prior written notice to the Village. Renewal certificates shall be provided to the Village not less than five (5) days prior to the expiration date of any of the required policies. All Certificates of Insurance shall be in a form acceptable to Village and shall provide satisfactory evidence of compliance with all insurance requirements. The Village shall not be obligated to review such certificates or other evidence of insurance, or to advise Contractor or Subcontractor of any deficiencies in such documents, and receipt thereof shall not relieve the Contractor or Subcontractor from, nor be deemed a waiver of the right to enforce the terms of the obligations hereunder. The Village shall have the right to examine any policy required and evidenced on the Certificate of Insurance.
- 18.9 Only in the event that the Work under the Contract Documents includes design, consultation, or any other professional services, Contractor or the Subcontractor shall procure, maintain, and pay for Professional Errors and Omissions insurance with limits of not less than \$2,000,000 per claim and \$2,000,000 annual aggregate. If such insurance is written on a claim made basis, the retrospective date shall be prior to the start of the Work under the Contract Documents. Contractor and all Subcontractors agree to maintain such

coverage for three (3) years after final acceptance of the Project by the Village or such longer period as the Contract Documents may require. Renewal policies during this period shall maintain the same retroactive date.

- 18.10 Any deductibles or selfinsured retentions shall be the sole responsibility of the Insured. At the option of the Village, either: the insurer shall reduce or eliminate such deductibles or selfinsured retentions as respects the Village, its officers, officials, employees and volunteers; or the Proposer shall procure a bond guaranteeing payment of losses and related investigations, claim administration and defense expenses.

19. COPYRIGHT/PATENT INFRINGEMENT

- 19.1 The Proposer agrees to indemnify, defend, and hold harmless the Village against any suit, claim, or proceeding brought against the Village for alleged use of any equipment, systems, or services provided by the Proposer that constitutes a misuse of any proprietary or trade secret information or an infringement of any patent or copyright.

20. COMPLIANCE WITH OSHA STANDARDS

- 20.1 Equipment supplied to the Village must comply with all requirements and standards as specified by the Occupational Safety and Health Act. All guards and protectors as well as appropriate markings will be in place before delivery. Items not meeting any OSHA specifications will be refused.

21. CERCLA INDEMNIFICATION

- 21.1 In the event this is a contract that has environment aspects, the Proposer shall, to the maximum extent permitted by law, indemnify, defend, and hold harmless the Village, its officers, employees, agents, and attorneys from and against any and all liability, including without limitation, costs of response, removal, remediation, investigation, property damage, personal injury, damage to natural resources, health assessments, health settlements, attorneys' fees, and other related transaction costs arising under the Comprehensive Environmental Response, Compensation, and Liability Act (CERCLA) of 1980, 42 U.S.C.A. Sec. 9601, *et seq.*, as amended, and all other applicable statutes, regulations, ordinances, and under common law for any release or threatened release of the waste material collected by the Proposer, both before and after its disposal.

22. CAMPAIGN DISCLOSURE

- 22.1 Any contractor, proposer, bidder or vendor who responds by submitting a bid or proposal to the Village of Downers Grove shall be required to submit with its submission, an executed Campaign Disclosure Certificate, attached hereto.
- 22.2 The Campaign Disclosure Certificate is required pursuant to the Village of Downers Grove Council Policy on Ethical Standards and is applicable to those campaign contributions made to any member of the Village Council.
- 22.3 Said Campaign Disclosure Certificate requires any individual or entity bidding to disclose campaign contributions, as defined in Section 9-1.4 of the Election Code (10 ILCS 5/9-1.4), made to current members of the Village Council within the five (5) year period preceding the date of the bid or proposal release.

- 22.4 By signing the bid or proposal documents, contractor/proposer/bidder/vendor agrees to refrain from making any campaign contributions as defined in Section 9-1.4 of the Election Code (10 ILCS 5/9-1.4) to any Village Council member and any challengers seeking to serve as a member of the Downers Grove Village Council.

23. SUBLETTING OF CONTRACT

- 23.1 No contract awarded by the Village shall be assigned or any part subcontracted without the written consent of the Village Manager. In no case shall such consent relieve the Contractor from their obligation or change the terms of the contract.

All approved subcontracts shall contain language which incorporates the terms and conditions of this Contract.

24. TERM OF CONTRACT

- 24.1 This Contract may be extended no more than twice for subsequent annual periods (two annual extensions) by mutual agreement of both parties, providing such agreement complies with Village purchasing policies and the availability of funds. However, if this Contract is not one that is subject to extension, such information will be available in the detailed specifications or special conditions section.

25. TERMINATION OF CONTRACT

- 25.1 The Village reserves the right to terminate the whole or any part of this Contract, upon written notice to the Contractor, for any reason and/or in the event that sufficient funds to complete the Contract are not appropriated by the Village.
- 25.2 The Village further reserves the right to terminate the whole or any part of this Contract, upon written notice to the Contractor, in the event of default by the Contractor. Default is defined as failure of the Contractor to perform any of the provisions of this Contract or failure to make sufficient progress so as to endanger performance of this Contract in accordance with its terms. In the event that the Contractor fails to cure the default upon notice, and the Village declares default and termination, the Village may procure, upon such terms and in such manner as the Village may deem appropriate, supplies or services similar to those so terminated. The Contractor shall be liable for any excess costs for such similar supplies or services unless acceptable evidence is submitted to the Village that failure to perform the Contract was due to causes beyond the control and without the fault or negligence of the Contractor. Any such excess costs incurred by the Village may be setoff against any monies due and owing by the Village to the Contractor.

26. BILLING & PAYMENT PROCEDURES

- 26.1 Payment will be made upon receipt of an invoice referencing Village purchase order number. Once an invoice and receipt of materials or service have been verified, the invoice will be processed for payment in accordance with the Village payment schedule. The Village will comply with the Local Government Prompt Payment Act, 50 ILCS 505/1 *et seq.*, in that any bill approved for payment must be paid or the payment issued to the Proposer within 60 days of receipt of a proper bill or invoice. If payment is not issued to the Proposer within this 60 day period, an interest penalty of 1.0% of any amount approved

and unpaid shall be added for each month or fraction thereof after the end of this 60 day period, until final payment is made.

- 26.2 The Village shall review in a timely manner each bill or invoice after its receipt. If the Village determines that the bill or invoice contains a defect making it unable to process the payment request, the Village shall notify the Contractor requesting payment as soon as possible after discovering the defect pursuant to rules promulgated under 50 ILCS 505/1 *et seq.* The notice shall identify the defect and any additional information necessary to correct the defect.
- 26.3 If this Contract is for work defined as a “fixed public work” project under the Illinois Prevailing Wage Act, 820 ILCS 130/2, any contractor or subcontractor is required to submit certified payroll records along with the invoice. No invoice shall be paid without said records.
- 26.4 Please send all invoices to the attention of Village of Downers Grove, Accounts Payable, 801 Burlington, Downers Grove, IL 60515.

27. RELATIONSHIP BETWEEN THE PROPOSER AND THE VILLAGE

- 27.1 The relationship between the Village and the Proposer is that of a buyer and seller of professional services and it is understood that the parties have not entered into any joint venture or partnership with the other.

28. STANDARD OF CARE

- 28.1. Services performed by Proposer under this Contract will be conducted in a manner consistent with that level of care and skill ordinarily exercised by members of the profession currently practicing in the same locality under similar conditions. No other representations express or implied, and no warranty or guarantee is included or intended in this Contract, or in any report, opinions, and documents or otherwise.
- 28.2 If the Proposer fails to meet the foregoing standard, Proposer will perform at its own cost, and without reimbursement from the Village, the professional services necessary to correct errors and omissions caused by Proposer’s failure to comply with the above standard and reported to Proposer within one (1) year from the completion of Proposer’s services for the Project.
- 28.3 For Professional Service Agreements (i.e. Engineer, Consultant): Project site visits by Proposer during construction or equipment installation or the furnishing of Project representatives shall not make Proposer responsible for: (i) constructions means, methods, techniques, sequences or procedures; (ii) for construction safety precautions or programs; or (iii) for any construction contractor(s’) failure to perform its work in accordance with contract documents.

29. GOVERNING LAW

- 29.1 This Contract will be governed by and construed in accordance with the laws of the State of Illinois without regard for the conflict of laws provisions. Venue is proper only in the County of DuPage and the Northern District of Illinois.

30. SUCCESSORS AND ASSIGNS

30.1 The terms of this Contract will be binding upon and inure to the benefit of the parties and their respective successors and assigns; provided, however, that neither party will assign this Contract in whole or in part without the prior written approval of the other. The Proposer will provide a list of key staff, titles, responsibilities, and contact information to include all expected subcontractors.

31. WAIVER OF CONTRACT BREACH

31.1 The waiver by one party of any breach of this Contract or the failure of one party to enforce at any time, or for any period of time, any of the provisions hereof will be limited to the particular instance and will not operate or be deemed to waive any future breaches of this Contract and will not be construed to be a waiver of any provision except for the particular instance.

32. AMENDMENT

32.1 This Contract will not be subject to amendment unless made in writing and signed by all parties.

33. NOT TO EXCEED CONTRACT

33.1 The contract price is a "not-to-exceed" cost. At any time additional work is necessary or requested, and the not-to-exceed price is increased thereby, any change, addition or price increase must be agreed to in writing by all parties who have executed the initial contract.

34. SEVERABILITY OF INVALID PROVISIONS

34.1 If any provisions of this Contract are held to contravene or be invalid under the laws of any state, country or jurisdiction, contravention will not invalidate the entire Contract, but it will be construed as if not containing the invalid provision and the rights or obligations of the parties will be construed and enforced accordingly.

35. NOTICE

35.1 Any notice will be in writing and will be deemed to be effectively served when deposited in the mail with sufficient first class postage affixed, and addressed to the party at the party's place of business. Notices shall be addressed to the Village as follows:

**Village Manager
Village of Downers Grove
850 Curtiss St.
Downers Grove, IL 60515**

And to the Proposer as designated in the Contract Form.

36. COOPERATION WITH FOIA COMPLIANCE

36.1 Contractor acknowledges that the Freedom of Information Act may apply to public records in possession of the Contractor or a subcontractor. Contractor and all of its subcontractors shall cooperate with the Village in its efforts to comply with the Freedom of Information Act. 5 ILCS 140/1 *et seq.*

37. DISADVANTAGED BUSINESS ENTERPRISE (DBE) CERTIFICATION

- 37.1 Pursuant to 35 ILCS 200/18-50.2, Contractor and all subcontractors are required to complete and submit a Vendor DBE certification, regardless of DBE status. Contractor shall complete and require all its subcontractors to complete the DBE certification for this project at www.downers.us/vss. The information necessary for the Contractor and all subcontractors to complete the certification includes the following: DBE Classification (minority-owned, women-owned, persons with disabilities-owned, veteran-owned, or none); if DBE, whether the company holds a certificate or self-certifies; if self-certifying, whether the company qualifies as a small business under the U.S. Small Business Administration standards; the company's name, address, city, state and zip code; company's contact person's name, title, telephone number and email address. NO PAYMENTS WILL BE MADE TO THE CONTRACTOR BY THE VILLAGE UNLESS AND UNTIL ALL OF THE CERTIFICATIONS FOR THE CONTRACTOR AND SUBCONTRACTORS HAVE BEEN COMPLETED.

III. DETAIL SPECIFICATIONS

The Village of Downers Grove, through its Fire Department, invites proposals from qualified manufacturers or authorized dealers for the purchase and delivery of self-contained breathing apparatus (SCBA), cylinders, face pieces, and related equipment, including training, warranty, and service support.

The Downers Grove Fire Department operates four stations and responds to structural, rescue, and hazardous materials incidents within a service area of approximately fifteen square miles. SCBA acquired through this procurement will be used for structural firefighting and other immediately dangerous to life and health (IDLH) environments.

Scope of Products and Services

Equipment Quantities

The Fire Department anticipates purchasing approximately

- 53 complete SCBA assemblies (backframe, harness, pressure reducer, hoses, regulator, integrated PASS, electronics).
- 92 SCBA cylinders: 30 minute rated service time
- 14 SCBA cylinders: 60 minute rated service time
- 92 face pieces, multiple sizes as needed for proper fit.
- 4 Rapid Intervention Team (RIT) kits, including cylinders.
- Associated accessories (voice amplification, heads-up displays, communication interfaces, etc.).

The Department reserves the right to increase or decrease quantities at the time of award, subject to available funding.

Standards and Certifications

All SCBA equipment shall:

- Comply with the most current edition of NFPA 1850, *Standard on Selection, Care, and Maintenance of Protective Ensembles for Structural and Proximity Firefighting and Open-Circuit Self-Contained Breathing Apparatus (SCBA)*.
- Comply with NFPA 1970, *Standard on Protective Ensembles for Structural and Proximity Firefighting, Work Apparel, Open-Circuit Self-Contained Breathing Apparatus (SCBA) for Emergency Services, and Personal Alert Safety Systems (PASS)*.
- Be certified by NIOSH for the intended use and pressure rating, and, if required, be CBRN-approved.

Technical Requirements

At a minimum, proposals shall address the following technical features:

- Open-circuit, positive-pressure SCBA design with rated service time of [30/45/60] minutes.
- Lightweight, composite cylinders with clear permanent labeling of manufacture and hydrostatic test dates.
- Integrated PASS device with audible and visual alarms meeting NFPA requirements.
- Heads-up display of cylinder pressure status visible to the wearer.
- Universal air connection (UAC) and compatibility with RIT or trans fill operations used by regional partners.
- Quick-disconnect or equivalent mechanism for regulator/face piece as specified.
- Electronic monitoring, data logging, and battery type/requirements.

Training

The successful proposer shall provide comprehensive training at no additional cost, including:

- On-site instruction for all shifts on operation, donning and doffing, emergency procedures, and routine inspection.
- Training on basic maintenance, battery replacement, and cleaning procedures.
- Training materials in electronic format (slides, manuals, videos, or equivalent) for ongoing internal training.

Warranty and Service Support

Proposers shall provide:

- A detailed warranty statement specifying coverage periods for SCBA frames, regulators, electronics, cylinders, and face pieces.
- Description of local or regional service capabilities, including:
 - Authorized repair facilities.
 - Typical turnaround times for warranty and non-warranty repairs.
 - Availability of loaner equipment meeting the same or comparable specifications.
- Recommended annual flow testing and preventive maintenance program, including the ability to perform testing on-site if offered and any additional costs therefore.

IV. PROPOSER'S RESPONSE TO RFP

(Proposer must insert response to RFP here. DO NOT insert a form contract, the RFP document including detail specs and Proposer's response will become the contract with the Village.)



Air One Equipment, Inc.
 360 Production Drive, South Elgin IL 60177
 Telephone: (847) 289-9000 Fax: (847) 289-9001
 website: www.aoe.net

**G1 SCBA
 RFP 2026**

FOR: DOWNERS GROVE FIRE DEPARTMENT **DATE:** 3/4/2026
 5420 MAIN STREET
 DOWNERS GROVE, IL 60515
ATTN: D/C MIKE MCGIVNEY **REF:** G1 2025 EDITION SCBA

Qty	Part Number	DESCRIPTION:	Each	Extended
53	* ATO *	MSA G1 FIRE SERVICE SCBA: NFPA 1970, 2025 EDITION 4500 PSI, QUICK CONNECT, STANDARD HARNESS WITH REMOVABLE SHOULDER & CHEST STRAPS, METAL CYLINDER BAND, ADJUSTABLE SWIVELING LUMBAR PAD, SOLID COVER REGULATOR UNIVERSAL RIT CONNECTION, HEADS UP DISPLAY SYSTEM, INTEGRATED VOICE AMPLIFIER SYSTEM, RIGHT SHOULDER PASS ALARM, and RECHARGEABLE BATTERY PACK	\$6,895.00	\$365,435.00
92	10175707	30-MINUTE (4500PSI) CARBON CYLINDERS W/QUICK CONNECT	\$950.00	\$87,400.00
14	10175710	60-MINUTE (4500PSI) CARBON CYLINDERS W/QUICK CONNECT	\$1,250.00	\$17,500.00
SCBA UPGRADE OPTIONS:				
53	* UEBS *	MSA EXTENDAIRE II UEBS/BUDDY BREATHER W/RESCUE HOSE	INCLUDED	\$0.00
PERSONNEL FACEPIECES				
90	10156459	MSA G1 FACEPIECE; NFPA 1970, 2025 EDITION; WITH 4-PT HARNESS	\$425.00	\$38,250.00
G1 SCBA ACCESSORIES				
4	10206313	G1 RIT SYSTEM: REGULATOR, FACEPIECE, L3 BAG & H60 CYLINDER	\$6,500.00	\$26,000.00
EXISTING EQUIPMENT TRADE-IN				
-52	2016	TRADE-IN MSA G1 SCBA MFG 2016	\$250.00	-\$13,000.00
-1	2024	TRADE-IN MSA G1 SCBA MFG 2024	\$1,500.00	-\$1,500.00
-4	RIT	TRADE-IN MSA G1 EQUIPMENT	\$250.00	-\$1,000.00
-90	FACE	TRADE-IN MSA G1 EQUIPMENT	\$25.00	-\$2,250.00
-90	H30	TRADE-IN MSA G1 EQUIPMENT	\$75.00	-\$6,750.00
-14	H60	TRADE-IN MSA G1 EQUIPMENT	\$100.00	-\$1,400.00

Total of All Equipment: \$508,685.00

- NOTES:**
1. ALL SCBA MEET NFPA1970, 2025 EDITION.
 2. ALL SCBA HAVE MSA 15 YEAR WARRANTY.
 3. INCLUDES IN-SERVICE TRAINING
 4. TRADE-IN QUOTE VALID THROUGH 6-30-2026

Thank You!

Estimated Delivery: **Martin J. Svihra**
Director of Operations

V. PROPOSAL/CONTRACT FORM

***THIS PROPOSAL, WHEN ACCEPTED AND SIGNED BY AN AUTHORIZED SIGNATORY OF THE VILLAGE OF DOWNERS GROVE, SHALL BECOME A CONTRACT BINDING UPON BOTH PARTIES.

Entire Block Must Be Completed When A Submitted Proposal Is To Be Considered For Award

PROPOSER:

Air One Equipment, Inc.

Company Name

Date: 02/10/2026

360 Production Drive

Street Address of Company

airone@aoe.net

Email Address

South Elgin, IL, 60177

City, State, Zip

Martin Svihra

Contact Name (Print)

847-289-9000

Business Phone

888-247-1204

24-Hour Telephone

847-289-9001

Fax

Sandra M. Frey
Signature of Officer, Partner or Sole Proprietor

Sandra M. Frey / President / *SECRETARY*

Print Name & Title

ATTEST: If a Corporation

David P. Frey
Signature of Corporation Secretary VICE PRESIDENT

VILLAGE OF DOWNERS GROVE:

Authorized Signature

Title

Date

ATTEST:

Signature of Village Clerk

Date

In compliance with the specifications, the above-signed offers and agrees, if this Proposal is accepted within 90 calendar days from the date of opening, to furnish any or all of the services upon which prices are quoted, at the price set opposite each item, delivered at the designated point within the time specified above.

PROPOSER'S CERTIFICATION (page 1 of 3)

With regard to SCBA Equipment, Proposer Air One Equipment, Inc. hereby certifies
(Name of Project) (Name of Proposer)
the following:

1. Proposer is not barred from bidding this contract as a result of violations of Section 720 ILCS 5/33E-3 (Bid Rigging) or 720 ILCS 5/33E-4 (Bid-Rotating);
2. Proposer certifies that it has a written sexual harassment policy in place and is in full compliance with 775 ILCS 5/2-105(A)(4);
3. Proposer certifies that it is in full compliance with the Federal Highway Administrative Rules on Controlled Substances and Alcohol Use and Testing, 49 C. F.R. Parts 40 and 382 and that all employee drivers are currently participating in a drug and alcohol testing program pursuant to the Rules.
4. Proposer further certifies that it is not delinquent in the payment of any tax administered by the Department of Revenue, or that Proposer is contesting its liability for the tax delinquency or the amount of a tax delinquency in accordance with the procedures established by the appropriate Revenue Act. Proposer further certifies that if it owes any tax payment(s) to the Department of Revenue, Proposer has entered into an agreement with the Department of Revenue for the payment of all such taxes that are due, and Proposer is in compliance with the agreement.

BY: *Andra M. Frey*
Proposer's Authorized Agent Signature

3	6	-	3	6	9	5	6	0	8
---	---	---	---	---	---	---	---	---	---

FEDERAL TAXPAYER IDENTIFICATION NUMBER

or _____
Social Security Number

Subscribed and sworn to before me
this 10th day of February, 2026.

Martin J. Svihra
Notary Public

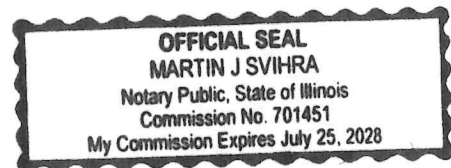

PROPOSER'S CERTIFICATION (page 2 of 3)

(Fill Out Applicable Paragraph Below)

(a) **Corporation**

The Proposer is a corporation organized and existing under the laws of the State of Illinois, which operates under the Legal name of Air One Equipment, Inc., and the full names of its Officers are as follows:

President: Sandra M. Frey

Secretary: Sandra M. Frey

Treasurer: N/A

and it does have a corporate seal. (In the event that this Proposal is executed by other than the President, attach hereto a certified copy of that section of Corporate ByLaws or other authorization by the Corporation which permits the person to execute the offer for the corporation.)

(b) **Limited Liability Company (LLC)**

The Bidder is a LLC organized and existing under the laws of the State of _____, which operates under the legal name of _____, and the full names of its managers or members are as follows:

Manager or Member: _____

Manager or Member: _____

Manager or Member: _____

Manager or Member: _____

(c) **Partnership**

Signatures and Addresses of All Members of Partnership:

PROPOSER'S CERTIFICATION (page 3 of 3)

The partnership does business under the legal name of: _____
which name is registered with the office of _____ in the state of _____.

(d) Sole Proprietor

The Proposer is a Sole Proprietor whose full name is: _____
and if operating under a trade name, said trade name is: _____
which name is registered with the office of _____ in the state of _____.

5. Are you willing to comply with the Village's preceding insurance requirements within 10 days of the award of the contract? YES NO (circle one)

Insurer's Name Arch Insurance Company

Agent Charles L. Crane Agency Co.

Street Address 400 Chesterfield Center. Suite 100

City, State, Zip Code Chesterfield, MO 63017

Telephone Number (636) 537-5000

I/We affirm that the above certifications are true and accurate and that I/we have read and understand them.

Print Name of Company: Air One Equipment, Inc.

Print Name and Title of Authorizing Signature: Sandra M. Frey / President

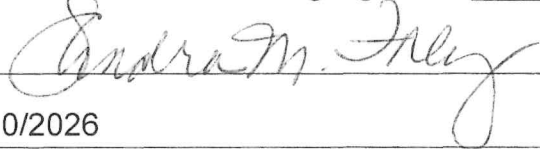
Signature: 

Date: 02/10/2026

Suspension or Debarment Certificate

Non-Federal entities are prohibited from contracting with or making sub-awards under covered transactions to parties that are suspended or debarred or whose principals are suspended or debarred. Covered transactions include procurement for goods or services equal to or in excess of \$100,000.00. Contractors receiving individual awards for \$100,000.00 or more and all sub-recipients must certify that the organization and its principals are not suspended or debarred.

By submitting this offer and signing this certificate, the Proposer certifies to the best of its knowledge and belief, that the company and its principals:

1. Are not presently debarred, suspended, proposed for debarment, declared ineligible or voluntarily excluded from covered transactions by any federal, state or local governmental entity, department or agency;
2. Have not within a three-year period preceding this Proposal been convicted of or had a civil judgment rendered against them for commission of fraud or a criminal offense in connection with obtaining, attempting to obtain, or performing a public (Federal, State or local) transaction or contract under a public transaction, or convicted of or had a civil judgment against them for a violation of Federal or state antitrust statutes or commission of embezzlement, theft, forgery, bribery, falsification or destruction of records, making false statements, or receiving stolen property;
3. Are not presently indicted for or otherwise criminally or civilly charged by a governmental entity (Federal, State, or local) with commission of any of the offenses enumerated in paragraph (2) of this certification; and
4. Have not within a three-year period preceding this application/proposal/contract had one or more public transactions (Federal, State or local) terminated for cause or default.

If the Proposer is unable to certify to any of the statements in this certification, Proposer shall attach an explanation to this certification.

Company Name: Air One Equipment, Inc.

Address: 360 Production Drive

City: South Elgin Zip Code: 60177

Telephone: (847) 289-9000 Fax Number: (847) 289-9001

E-mail Address: airone@aoe.net

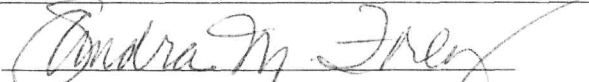
Authorized Company Signature: 

Print Signature Name: Sandra M. Frey Title of Official: President

Date: 02/10/2026

CAMPAIGN DISCLOSURE CERTIFICATE
--

Any contractor, proposer, bidder or vendor who responds by submitting a bid or proposal to the Village of Downers Grove shall be required to submit with its submission, an executed Campaign Disclosure Certificate.

The Campaign Disclosure Certificate is required pursuant to the Village of Downers Grove Council Policy on Ethical Standards and is applicable to those campaign contributions made to any member of the Village Council.

Said Campaign Disclosure Certificate requires any individual or entity bidding to disclose campaign contributions, as defined in Section 9-1.4 of the Election Code (10 ILCS 5/9-1.4), made to current members of the Village Council within the five (5) year period preceding the date of the bid or proposal release.

By signing the bid or proposal documents, contractor/proposer/bidder/vendor agrees to refrain from making any campaign contributions as defined in Section 9-1.4 of the Election Code (10 ILCS 5/9-1.4) to any Village Council member and any challengers seeking to serve as a member of the Downers Grove Village Council.

Under penalty of perjury, I declare:

Bidder/vendor has not contributed to any elected Village position within the last five (5) years.

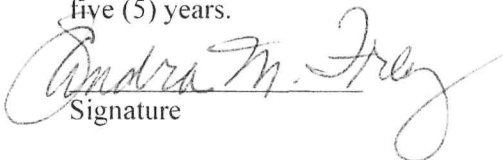
Signature

Sandra M. Frey
Print Name

Bidder/vendor has contributed a campaign contribution to a current member of the Village Council within the last five (5) years.

Print the following information:

Name of Contributor: _____
(company or individual)

To whom contribution was made: _____

Year contribution made: _____ Amount: \$ _____

Signature

Print Name



MSA G1™ XR SCBA 2025 Edition

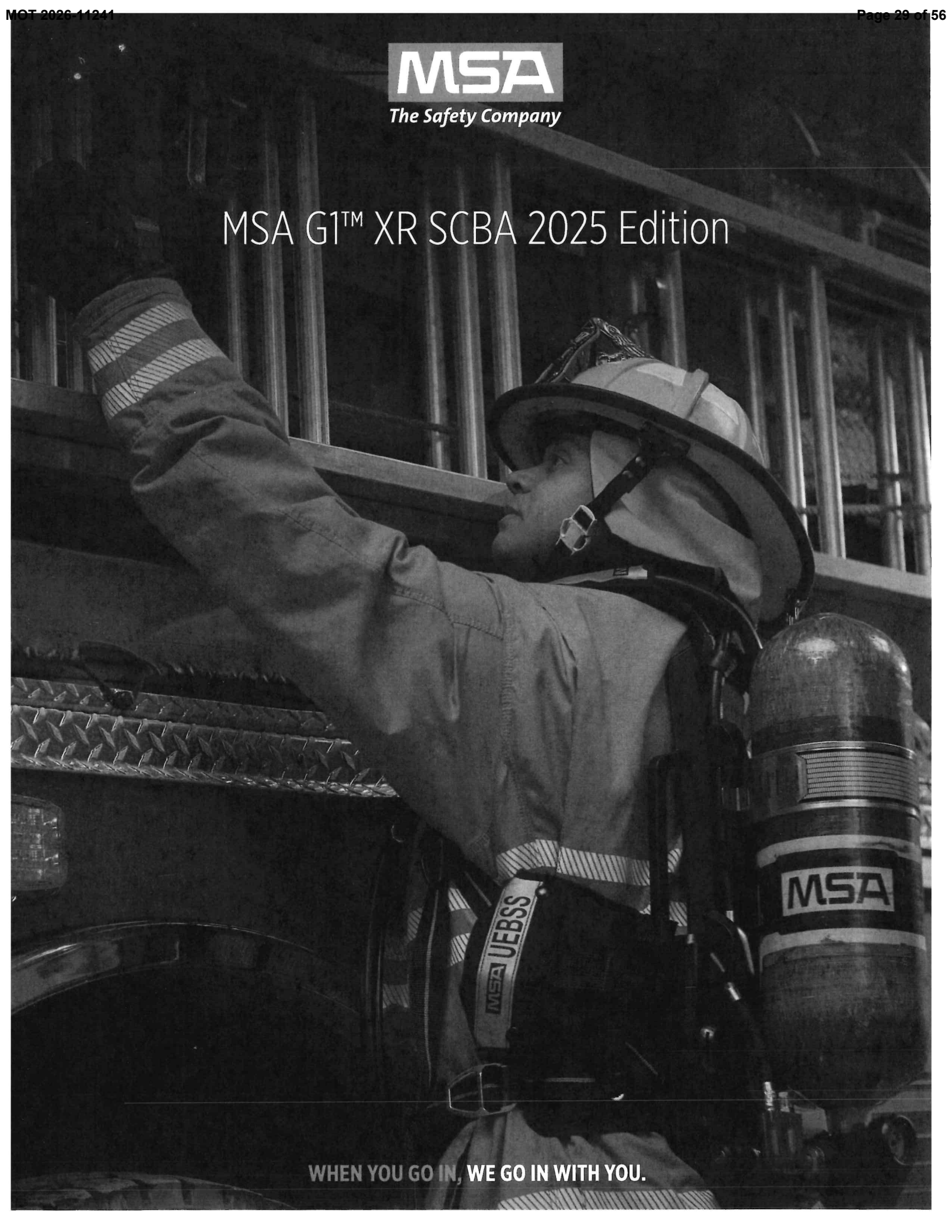

WHEN YOU GO IN, WE GO IN WITH YOU.

MSA G1 SCBA

Fire Service Equipment

Products for today that drive the future.

As your emergency responder duties expand, as well as your exposure to hazards, MSA continues to provide more emergency response products to exceed your expectations and requirements. MSA supports firefighters and recognizes your role as the front line of protecting others. We are constantly improving products that you have come to rely upon as the best in the industry, to make your job safer and easier. For your protection, you can count on MSA for the most technologically advanced products, and for the best support and training assistance.



We are committed to you.

Working closely with firefighters and rescue teams for over 100 years, MSA's premier focus continues to be the fire service for product innovations, improvements and service. From our Cairns® Fire Helmets, and breakthrough ALTAIR® Gas Detectors, to the most advanced, safety driven breathing apparatus we've ever produced, the G1 SCBA, you can rely upon MSA to offer the very best in personal protective equipment. Your options in gas detection instruments and fall protection/rescue systems are more numerous and better than ever. Our MSA-U® Training Center online training tool provides in-depth product training with team-tracking capability that allows 24/7 instruction for your entire squad. And now Globe, the world's leading maker of innovative protective clothing for firefighters, is part of MSA. Equipping firefighters with the highest level of protection – head to toe, Cairns helmet to Globe boots – no one is as committed to your health and safety as we are.

Our people set us apart from the competition.

MSA's SCBA are manufactured at our award-winning Murrysville, PA facility. Whether your needs include the revolutionary G1 SCBA or a Cairns® Helmet made in Jacksonville, NC, you can be sure that each of them has been made with the dedicated care and skill of an MSA associate whose average time on the job of 18 years means consistent quality, time after time.

Assistance is everywhere.

Your personalized service starts locally with your trained MSA-authorized distributor and MSA's fire service field sales managers. To locate your nearest MSA fire service distributor, or find an answer to an urgent technical question, our award winning, dedicated team of customer service professionals is ready to help, as they understand your hazards as well as regulatory compliance. Contact them at 1-877-MSA-FIRE or visit us at www.MSAFIRE.com.

MSA G1 SCBA

 MSA
The Safety Company

MSA G1 SCBA iTIC

Find the Hot Spots. And the Heartbeats.

MSA provides personal thermal imaging to every firefighter—from 360 to rescue; egress to overhaul.

The FIRST and ONLY TIC Integrated Directly into the SCBA.

- No additional bulky equipment added to your facepiece or hanging from your gear
- Compatible with all G1 SCBA via simple field upgrade
- Powered by the G1 SCBA's single integrated power source – never check multiple battery locations again
- Single button functionality allows for simple, intuitive use

Take Advantage of the Latest Technology.

- Lightweight—only adds 4.2 oz. compared to standard MSA G1 Control Module
- Up to five user-selectable palettes – 10+ additional palettes available via MSA A2 Software
- 220 x 176 resolution ensures crystal clear images
- Compliant to the 2025 Edition of the NFPA 1970 standard
- A full five-year warranty on thermal imager. Additional 15 years extended warranties available.

MSA G1 SCBA

The MSA G1 SCBA stands out from the crowd.



1 Facepiece

- Open port design with cross-contamination protection
- Comfortable and easy to use, with low breathing resistance on and off air
- Zero electronics, reducing weight, snag hazards and cost

2 Control

- Integrated Thermal Imaging Camera (TIC) allows firefighter to see within dark, smoke-filled environments
- Five user-selectable palettes – 10+ additional programmable palettes available via MSA A2 Software
- Compatible with all G1 SCBA via simple field upgrade
- Control module provides both color LCD and analog displays
- Display automatically turns on when control module is lifted into viewing position
- No matter which button is pressed, necessary information displays
- Improved visibility through buddy lights

3 Situational Awareness

- Wide field of view through the G1 Facepiece
- Seven three-stage buddy lights providing 360-degree visibility of pressure status
- Highly reflective material on shoulder straps and cylinder band
- Optional integrated TIC provides visibility when it is needed most

4 Information

- HUD provides more information than ever before and can be customized to meet your SOP; cylinder pressure, battery status, evacuation (optional), and so much more

5 Communications

- Loud and clear communications are included with every G1 SCBA
- Intelligently removes background and inhalation noise, helping your commands to be heard

MSA G1 SCBA



6 Comfort

- Swiveling, adjustable lumbar pad properly positions SCBA weight
- Improved comfort, balance, fit
- Low profile swiveling lumbar pad reduces weight and positions backframe close to the body

7 Power

- Single power source
- Uses alkaline or rechargeable battery
- Eliminates the need to maintain multiple battery sizes or multiple battery locations
- Low cost of ownership

8 Ready for the Future

- Bluetooth connectivity, RFID, Near Field Communication (NFC), long-range radio
- Quickly update the G1 SCBA with the latest advancements through Bluetooth technology, ensuring the SCBA you buy today can easily adapt to meet your needs far into the future

9 Built Just for You

- Control module and HUD display required information; easily customized to meet your existing standard operating procedure
- Modular designs allows for quick component change

MSA G1 SCBA

About FACE

The G1 Facepiece was designed without electronic components to minimize weight, reduce your stress and fatigue and improve your overall performance level. There are no electronic components on the outside of the facepiece that may result in snag and entanglement hazards. What's more, by eliminating costly electronic components, the price is reduced substantially, allowing personal-issue facepieces to be a cost-effective measure. The G1 facepiece utilizes an inhalation check valve when the second stage regulator is connected, which directs potentially contaminated exhaled air away from the second stage regulator. But MSA didn't stop there. The MSA G1 SCBA is also equipped with a speaking diaphragm to increase speech clarity while off air.

Taking the preferred features of the Ultra Elite Facepiece—Comfort, Field of View, Superior Communications, and Fit—we've taken the G1 Facepiece to the next level with an Open-Port that provides low breathing resistance in standby modes.

The G1 Facepiece can help you to conserve energy for when you need it most.

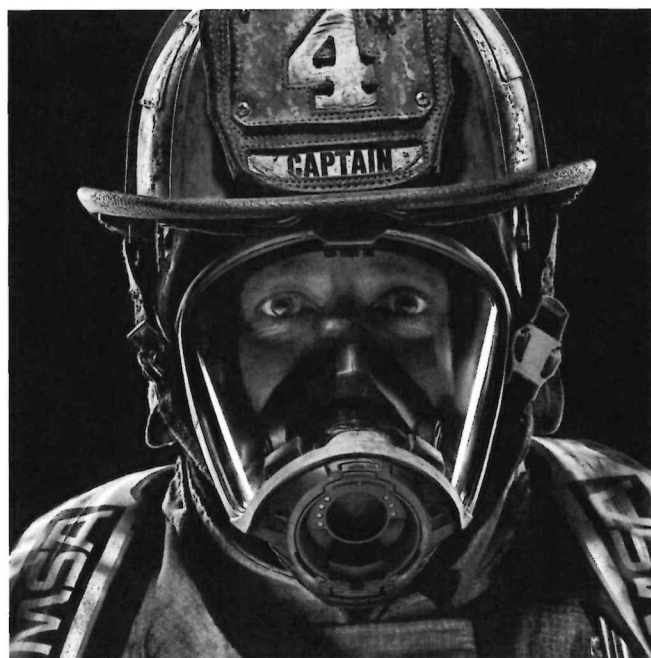

Be Heard

Electronic Voice Amplification Shouldn't Be Optional. Every MSA G1 SCBA is equipped with electronic voice amplification because high quality fireground communications shouldn't be optional. With patent-pending design, dual microphones integrated into the regulator eliminate the Darth Vader-like inhalation sound. This unique feature automatically activates and shuts down with the unit. Shoulder strap-mounted speaker module provides loud and clear communications from the regulator microphone while maintaining low profile to aid in reducing snag points. Every MSA G1 SCBA is equipped with this cutting-edge technology.

Heads Up

Internal HUD display. No facepiece electronics? It's not only possible, it's here. By placing electronics that power the heads up display within the regulator, MSA has effectively reduced weight, profile, pairing, and cross talk. The HUD is inside the facepiece, so external contaminants cannot block the view and vital displayed relayed information. This design means that you no longer have to buy HUDs for each facepiece, reducing costs and maintenance. By using revolutionary light pipes, the MSA G1 SCBA heads up display is clear and simple to understand; it's a HUD system made easy!



MSA G1 SCBA

Designed to Fit YOUR Needs

Cutting-edge technology. The MSA G1 SCBA with Integrated TIC meets your demands, providing more functionality and safety than ever before. G1 Control Module integrates TIC technology to eliminate the need to carry more gear while adding speed and effectiveness. The iTIC draws power from G1 Power Module—no separate battery is necessary. Control Module offers both analog and color digital LCD displays to make certain that your status is available at all times. Autostart motion control mechanism built into the control module intuitively provides the information you need when you need it. Adding yet another layer to ease-of-use: no matter which button is pressed, your information displays.

Highly configurable and customizable. The MSA G1 SCBA's user-selectable configurations are an industry first: pressure, time remaining calculation, breathing time, temperature (the ability to set your own temperature alarm), and pressure drop (to alert you to leaks, either primary or secondary). What's more, the control module and HUD can be programmed to display information required by your particular specification. But best of all, electronics can be adjusted to YOUR needs. The MSA G1 SCBA provides the ability to configure this device to follow any standard operating procedure, with alarm settings, lights and information provided on the control module. The MSA G1 SCBA is designed for the flexibility you need! The G1 Facepiece can help you to conserve energy for when you need it most.



Always in Demand

G1 Mask-Mounted Regulator. The G1 T4 Regulator houses easy-to-operate heads up display and communications, yet is the smallest and lightest regulator available. The G1 Regulator has an optional purge cover that can be used to start air flow during emergency situations. The G1 Regulator can also be shut off and removed from the mask with one simple action!

The G1 Regulator is always in DEMAND!

MSA G1 SCBA

The Power of One

Central Power System. With only one centralized power source, you can use either alkaline or an industry-first rechargeable battery. As the first manufacturer to offer rechargeable batteries, we've taken SCBA protection to a whole new level — finally, an SCBA that doesn't require multiple battery sizes! No need to manage battery types, compartments and change-outs, resulting in lower cost of ownership.

Finally, an SCBA Where One Size Really Can Fit All

Ergonomics. The MSA G1 SCBA is the only SCBA on the market that offers harness customization to ensure improved comfort, balance and fit. By providing an adjustable lumbar pad, you can have a tailored unit with up/down and pivot capabilities that can actually move with you. Widened, adjustable shoulder straps enhance weight distribution and comfort.

Through use of interlocking shoulder straps and strategically placed friction pads, the MSA G1 SCBA provides increased fit and stability while allowing for easy donning and doffing.

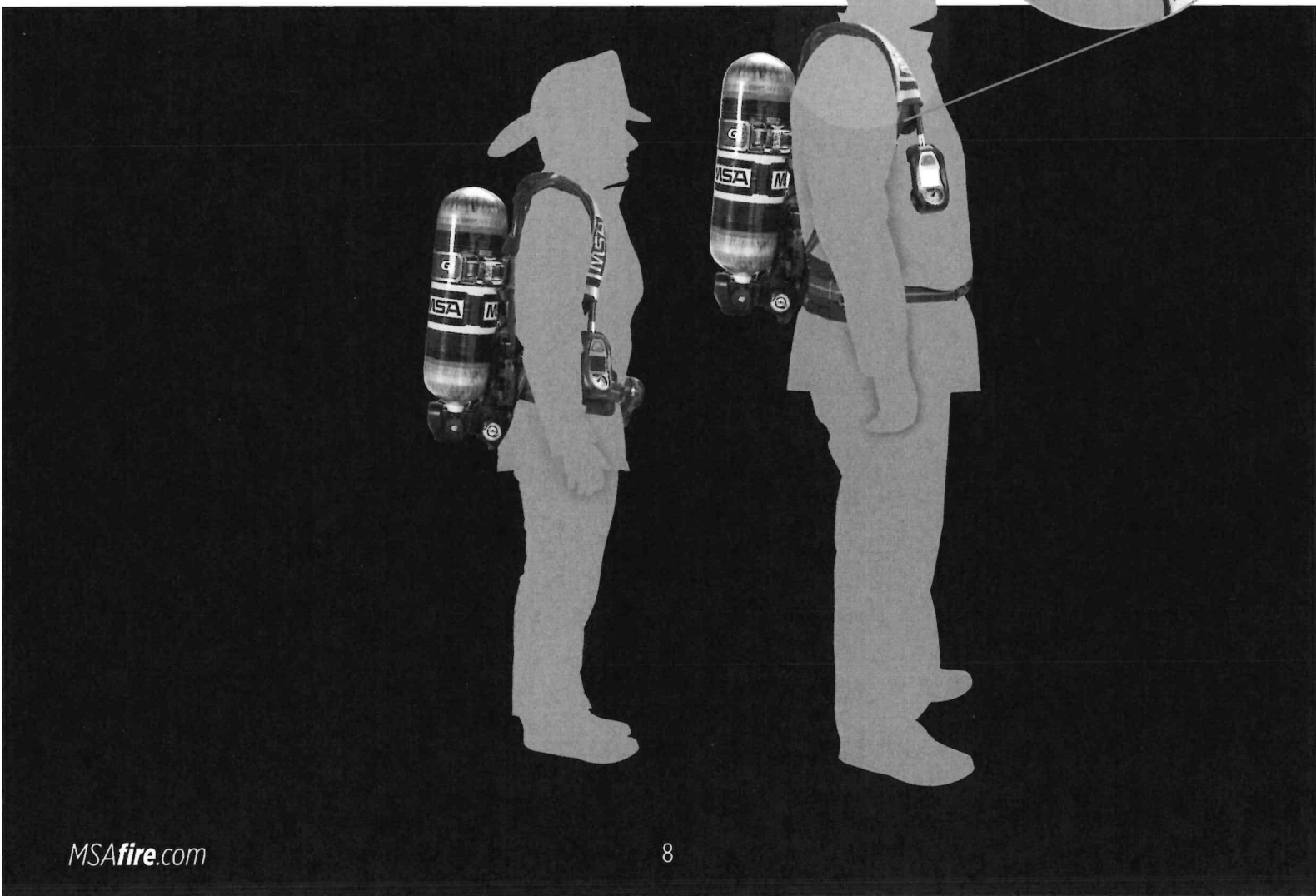
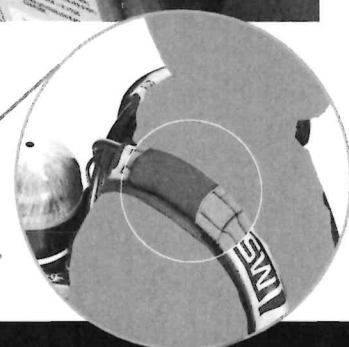

MSA G1 SCBA

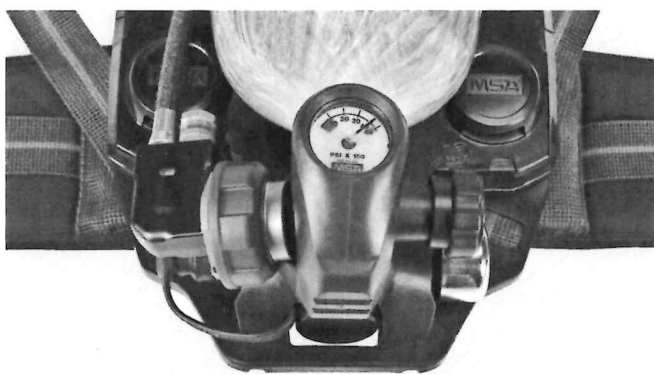

Make a Connection

Pressure Reducer. Designed to work with quick-connect or CGA threaded cylinders, there's a connection to meet your needs. Pressure reducer accessory ports allow for future upgrades, including the high pressure Quick-Fill® System. The MSA G1 SCBA is available in both quick-connect and threaded-connection options. With minimal parts, you can easily upgrade from one option to the other! All in all, this unit provides each user with many choices, all of which result in lower cost of ownership.



When Air is Low, Seconds Matter

Universal Air Connection (UAC). When air is low and you must access the UAC for emergency purposes, seconds matter. That's why MSA invented the patent-pending RIT light to shine a bright white LED on the UAC connection, making it easier to find and connect to a rescue air source. The primary UAC illuminates when end of service time indicator (EOSTI) is initiated.



Find the Hot Spots. And the Heartbeats.

The MSA G1 SCBA with Integrated Thermal Imaging Camera provides EVERY firefighter with the ability to see within dark and smoke-filled environments, aiding in your operation's speed and effectiveness from the initial 360, to working the fire, overhaul and rescue. This sight is provided through a thermal imaging camera that is integrated into the G1 SCBA Control Module, eliminating the need to carry additional equipment and the concern of snag hazards.

- Compatible with all G1 SCBA via simple field upgrade
- Powered by the G1 SCBA single integrated power source – never check multiple batteries again
- Single button functionality allows for simple, intuitive use
- Lightweight - Adds only 4.2 oz. as compared to standard G1 Control Module
- Up to five user-selectable palettes
 - 10+ additional palettes available via MSA A2 Software
- 220 x 176 display ensures crystal clear images

MSA G1 SCBA

A Faster Responder

Conditions faced by firefighters on a daily basis have changed dramatically through the years. The MSA G1 SCBA is designed with technology to drive firefighting into the future. Use of Bluetooth, Radio-Frequency Identification (RFID), Near Field Communication (NFC), and long-range capability allows for fast and easy integration of current and future technologies, providing firefighters with the latest tools available to get their job done.

- MSA G1 SCBA Bluetooth module uses audio and data channels to communicate with Motorola, Kenwood, BKR, and L3 Harris. Use of the same Bluetooth connection lets users connect to the G1 SCBA via MSA A2 Software for custom configuration to your department's standard operating procedures.
- RFID reader/writer stores comprehensive tag information and enables pairing with Bluetooth devices. Incorporated Bluetooth provides data link capability for SCBA data log retrieval and electronics troubleshooting.
- Long-range radio communication provides incident command with specific personnel information through MSA A2 or FireGrid software.



Bluetooth link status

Long-range radio status

Configurable display



MSA G1 5500 SCBA

Staying at the forefront of safety means constantly evolving to meet the ever-changing demands you face each day on the job. Helping meet these demands MSA's tried-and-trusted G1 SCBA now comes available in a 5500 psig operating system. The MSA G1 offers our lowest profile, most comfortable, streamlined, balanced and configurable SCBA with the lightest weight 5500 psi cylinders on the market today, providing its users:

- Reduced stress and fatigue
- Increased maneuverability in tight spaces, reducing your chance of getting snagged, improving your mobility, and helping keep you safe in dangerous environments
- 30-, 45-, or 60-minute duration cylinders allows you to keep the same operating system, while reducing weight, profile, additional training time and overall expenses

MSA G1 SCBA Accessories

MSA G1 SCBA Rechargeable Battery

MSA offers the first NIOSH-approved and NFPA-compliant SCBA platform to provide a rechargeable battery, eliminating the need for disposable replacement batteries. Portable and compact rapid charger can charge up to six batteries at once; batteries can reach full charge in just six hours.

- Reduced cost of ownership, never waste money on disposable batteries
- No need for multiple battery sizes in multiple locations
- Never waste time on alkaline battery replacement
- Single source powers entire SCBA
- Save 1/2 lb. when compared to alkaline battery pack
- Rapid charging with available smart charger.



PART NUMBER	Description
10148741-SP	MSA Rechargeable Battery
10158385	MSA G1 Charger

* Charger not included

MSA G1 ExtendAire II System

MSA G1 ExtendAire II System is a Universal Emergency Breathing Supply System (UEBSS) accessory that uses intermediate-pressure air to provide firefighters with emergency breathing air by allowing firefighters to quickly and easily interconnect to fellow firefighter's air supply. System integrates into G1 SCBA, providing unrestricted mobility and easy access during emergency situations. Locking quick-connects with integrated check valve prevent contamination of breathing air pathway by ambient atmosphere.

G1 ExtendAire II System features integrated rescue hose and manifold assembly that uses both male and female quick-connect fittings, and stows in low-profile pouch that mounts on carrier assembly.

G1 ExtendAire II System is NIOSH-approved and NFPA 1970-2025 edition-compliant.



EXTENDAIRE II SYSTEM	10205767	ExtendAire II System Conversion Kit for G1 SCBA, UEBSS, 2018/2025 ed
	10203820	Replacement pouch for G1 ExtendAire II System, UEBSS, 2018/2025 ed.
	10156464	ExtendAire II System Conversion Kit for G1 SCBA, 2013 ed.
	10156466-SP	Replacement pouch for G1 ExtendAire II System, 2013 ed.

MSA G1 SCBA

The Quick-Fill System

The Quick-Fill System lets MSA air mask users refill and transfill air cylinders* while SCBA is worn, without removing the air cylinder—even in IDLH atmospheres. Use this MSA option to:

- Fill SCBA cylinder from a mobile compressor or cascade system in less than a minute.
- Transfill between two cylinders, providing emergency breathing system.*
- Extend air supply over longer durations, using a remote compressed-air source.

Air masks compliant to recent NFPA standards have Quick-Fill System URC fitting located at the Audi-Larm Audible Alarm warning device. Quick-Fill System hose with quick-disconnect connects air source to adapter for air transfer. See Bulletin 0105-92-MC for a Quick-Fill System Q&A.



QUICK-FILL SYSTEM REPLACEMENT	10156465	Waist-mounted Quick-Fill System for MSA G1 SCBA
	10156467	Replacement Quick-Fill System pouch for MSA G1 SCBA
	10156468	3-ft. Quick-Fill System hose in pouch for MSA G1 SCBA

	25 ft.	12 ft.	10 ft.	8 ft.	6 ft.	3 ft.	
QUICK-FILL SYSTEM HOSES	485332	802690	802689	802688	802687	485331	FQD x FQD *
	487907	802677	802675	802673	802671	492796	FQD x CGA-347 outlet
	487909	802685	802683	802681	802679	487427	FQD x CGA-347 CN
	487906	802704	802703	802702	802701	802705	FQD x SAE-4
	487908	802678	802676	802674	802672	492797	FQD x CGA-346 outlet
	487910	802686	802684	802682	802680	487428	FQD x CGA-346 CN

MSA G1 RIT Systems

The Quick-Fill System lets MSA air mask users refill and transfill air cylinders* while SCBA is worn, without removing the air cylinder—even in IDLH atmospheres. Use this MSA option to:

- Fill SCBA cylinder from a mobile compressor or cascade system in less than a minute.
- Transfill between two cylinders, providing emergency breathing system.*
- Extend air supply over longer durations, using a remote compressed-air source.

Air masks compliant to recent NFPA standards have Quick-Fill System URC fitting located at the Audi-Larm Audible Alarm warning device. Quick-Fill System hose with quick-disconnect connects air source to adapter for air transfer. See Bulletin 0105-92-MC for a Quick-Fill System Q&A.

PART NUMBERS	Operating Pressure	Description
10206310	2216	G1 RIT System, FCPC, Regulator, 6-Ft Quick-Fill & ExtendAire II Systems (UEBSS, 2018/2025 ed.), remote gauge, URC, Quick-Connect
10169710	2216	G1 RIT System, FCPC, Regulator, 6-Ft Quick-Fill & ExtendAire II Systems (2013 ed.), remote gauge, URC, Quick-Connect
10206311	4500	G1 RIT System, FCPC, Regulator, 6-Ft Quick-Fill & ExtendAire II Systems (UEBSS, 2018/2025 ed.), remote gauge, URC, Thread Connect
10206313	4500	G1 RIT System, FCPC, Regulator, 6-Ft Quick-Fill & ExtendAire II Systems (UEBSS, 2018/2025 ed.), remote gauge, URC, Quick-Connect
10169711	4500	G1 RIT System, FCPC, Regulator, 6-Ft Quick-Fill & ExtendAire II Systems (2013 ed.), remote gauge, URC, Quick-Connect
10192465	4500	G1 RIT System, FCPC, Regulator, 6-Ft Quick-Fill & ExtendAire II Systems (2013 ed.), remote gauge, URC, Thread Connect
10206312	5500	G1 RIT System, FCPC, Regulator, 6-Ft Quick-Fill & ExtendAire II Systems (UEBSS, 2018/2025 ed.), remote gauge, URC, Quick-Connect
10197179	5500	G1 RIT System, FCPC, Regulator, 6-Ft Quick-Fill & ExtendAire II Systems (2013 ed.), remote gauge, URC, Quick-Connect

Note: This RIT system does NOT include cylinder. Please see cylinder ordering information.

MSA G1 SCBA



G1 RescueAire® II System

The MSA G1 RescueAire II System for Rapid Intervention Teams (RITs) provides firefighters with emergency breathing air, including air supply to trapped firefighters wearing SCBA with compatible system(s). Built for extreme fire service conditions, G1 RescueAire II System offers two operating pressures, 2216 and 4500 psi. Optional-use shoulder strap provides hands-free carrying.

System incorporates G1 Regulator; RIT teams can provide air to downed firefighter wearing G1 Facepiece. G1 Regulator connects directly to G1 Facepiece for maximum rescue capability, supported by flame and heat-resistant carrying harness of Nomex and Kevlar materials.

G1 RescueAire II System includes:



- SuperLite® Cylinder
- 36" Quick-Fill System EBS Connection
- ExtendAire System EBS Connection
- G1 PR-14 Pressure Reducer
- G1 Regulator
- Carrying harness with adjustable shoulder strap
- Audi-Larm™ Audible Alarm low pressure warning device

PART NUMBER	Description
10161130	RescueAire II System, Snap-Tite, 4500, 60-min cylinder
10161142	RescueAire II System, Snap-Tite, 4500, less cylinder
10161141	RescueAire II System, Snap-Tite, 2216, 30-min cylinder
10161143	RescueAire II System, Snap-Tite, 2216, less cylinder
10207540	RescueAire II System, UEBSS, 4500, 60-min cylinder
10207542	RescueAire II System, UEBSS, 4500, less cylinder
10207541	RescueAire II System, UEBSS, 2216, 30-min cylinder
10207543	RescueAire II System, UEBSS, 2216, less cylinder

MSA Rescue Belt II System for MSA G1 SCBA

MSA's innovative device for emergency egress, the Rescue Belt II System for the G1 SCBA, is an integrated personal escape system that allows firefighters to rappel to safety should they become trapped in a building's upper level. G1 Rescue Belt II System is NFPA 2500-certified for use as a personal escape system for emergency escape when installed on MSA-approved air masks. Device can also be used as a standalone product when not installed on an air mask. The Rescue Belt II System can be ordered as an MSA G1 SCBA option or as an individually-sold component for upgrade of your existing MSA G1 SCBA.



Rope	Connectors		
	 Crosby Hook	 Carabiner	 Lightning GT Hook
50-FT. MSA SAFETECH	10173102	10173103	10173105

MSA G1 SCBA

MSA G1 PremAire® Cadet Escape Respirator

This combination supplied-air respirator with escape cylinder is used for entry into or escape from hazardous, confined space or immediately dangerous to life or health atmospheres. Streamlined, lightweight design incorporates a technologically advanced, light, low profile, open-port facepiece that provides cross-contamination protection.

- One-piece cylinder valve and first-stage regulator incorporates downstream design to reduce moisture buildup and dual springs for maximum reliability.
- Low-profile escape cylinder is worn on either right or left hip for easier movement within tight spaces.
- Shoulder support strap incorporates hose keeper; regulator hose stays close to body to reduce snagging.
- Escape cylinders rated at 5-, 10- and 15-minutes.
- Pressure gauge recessed into valve housing protects gauge and reduces size and profile.
- Two harness materials: standard nylon for chemical resistance and Kevlar for high heat environments or those with spark potential.
- Regulator offers bypass and purge cover.
- NIOSH-approved as combination supplied-air respirator and self-contained breathing apparatus.



Ordering Selection Matrix

A Type

PCG PremAire Cadet Escape G1

B Carrier & Harness Type

- 1 Nylon, strap carrier, standard
- 2 Kevlar, strap carrier, standard
- 3 Nylon, bag carrier, standard
- 4 Kevlar, bag carrier, standard

Notes:

Aluminum escape cylinders are not compatible with bag carriers.

C Pad Option

- 0 None
- 1 Shoulder

D Escape Cylinder

- A 5-minute aluminum
- B 10-minute aluminum
- C 5-minute carbon
- D 10-minute carbon
- E 15-minute carbon
- F 5-minute aluminum, less air
- G 10-minute aluminum, less air
- H 5-minute carbon, less air
- J 10-minute carbon, less air
- K 15-minute carbon, less air

E MMR Regulator

A G1 Regulator, purge cover

F G1 Facepiece

- 1 None
- 2 G1 Facepiece with 4-pt adjustable head harness, medium^m
- 3 G1 Facepiece with 5-pt adjustable head harness, medium^m
- 4 G1 Facepiece with rubber head harness, medium^m

Notes:

If desired facepiece is not available here, choose "None" and select from the G1 Facepiece ATO.

G Quick Disconnect

- 0 None
- A Snap-Tite, aluminum
- B Snap-Tite, stainless steel
- C Snap-Tite, brass
- D Hansen, stainless steel
- E Hansen, brass
- F Foster, steel
- G Foster, stainless steel
- H Foster, brass
- J Snap-Tite, locking, aluminum
- K Snap-Tite, locking, stainless steel
- M Snap-Tite, locking, brass
- N Foster, stainless steel
- P Cejn, locking

H Case

- 0 None
- 1 Hard plastic case

Key:

^m Facepiece includes nosecup, but does not include neckstrap.

Note:

An additional surcharge will be added to configurations that are classified as hazardous materials

A	PCG								Quantity
	A	B	C	D	E	F	G	H	

PART NUMBER

MSA A2 Configuration Software

MSA A2 Software offers the ability to customize your SCBA to meet your SOP, analyze use data and reliably enhance firefighter safety and accountability on the fire scene. Software monitors firefighter status remotely from incident command. In-depth reporting capabilities include data log search for incident reports by date and/or alarm type; reports can be exported, filtered, printed, and more. Users can also retrieve event logs for any recorded incidents.

- Software provides the ability to configure alarm, control module, accountability, speaker module, and HUD settings.
- MSA G1 SCBA stores usage data; MSA A2 Software allows viewing of incident date, duration, air used, alarm status, and more.
- Tag creation allows G1 SCBA customization to meet your needs and track the location of each component. Incident event logs include date, time, duration, incident number, dispatch center number, firefighter name, firefighter team, PASS device serial number, time firefighter went on-air, any event recorded, and pressure remaining when event occurred.



Additional G1 SCBA Accessories

Part Number	Description
10148740-SP	Replacement alkaline battery pack
10148741-SP	Replacement rechargeable battery pack
10158385	Rechargeable battery charging station
10149701-SP	Quick-connect adapter for 2216 psig cylinders
10149702-SP	Quick-connect adapter for 4500/5500 psig cylinders
10158389	Retainer Kit for H-30 carbon (807587) 4500 psig (Type 2 - dovetail)
10158390	Retainer Kit for H-45 LP carbon (10035644) 4500 psig (Type 3 - dovetail)
10158401	Retainer Kit for L-30 carbon (807586) 2216 psig (Type 4 - dovetail)
10162403	Quick-connect adapter for fill station
10158401	Retainer Kit for H-45 carbon (807570) 4500 psig (Type 4 - dovetail)

Part Number	Description
10158402	Retainer Kit for H-60 carbon (807588) 4500 psig (Type 5 - dovetail)
10158408	Quick-connect adapter for fill station
10164940	G1 Custom Tool Kit
10083875	RFID Tag
10158407	RFID reader/writer (primary use with A2)
10186214	RFID read only (primary use with AIMS)
10175010-SP	G1 Control Module w/ Integrated TIC upgrade kit - 2216 psig
10175021-SP	G1 Control Module w/ Integrated TIC upgrade kit - 4500/5500 psig
10183992	Kit, Protective Cap & Boot for 30 min cylinder
10183993	Kit, Protective Cap & Boot for 45 min LP cylinder

MSA Connected Firefighter Platform

FireGrid

FireGrid is a suite of cloud-connected applications that provide accurate and timely safety information, with minimal to no additional burden, to enable fire departments to make faster, more informed, and confident decisions during live events and post-scene. FireGrid's applications enhance, automate, and digitize manually burdensome existing incident management, reporting, and inventory management processes.

MSA's applications leverage on-scene device data to enable Incident Commanders to make more-informed decisions and aid in reducing cognitive overload through increased situational awareness of devices, personnel and event data. Post-scene, FireGrid provides automated report generation, capturing detailed device and personnel data from cloud-connected devices. On-scene product usage information is automatically stored in the cloud to access from anywhere.

Inventory management is enabled by a centralized, cloud-based digital asset management and compliance application. Simply using the connected devices drives usage-based preventative maintenance, enhanced fleet management, improved resource efficiency and the ability to avoid over-servicing product due to the on-scene data automatically documenting and storing in the inventory management application.

FireGrid aids in ensuring all products are compliant and ready for use through summary dashboards and assigning inspection and service procedure reminders. Dashboard analytics visualize department trends to understand what's happening over time.

LOCAL MONITORING

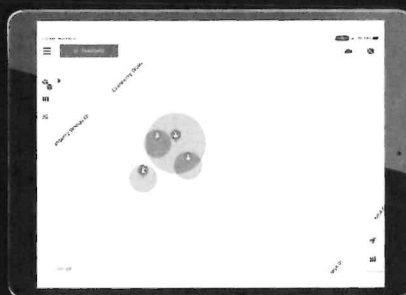
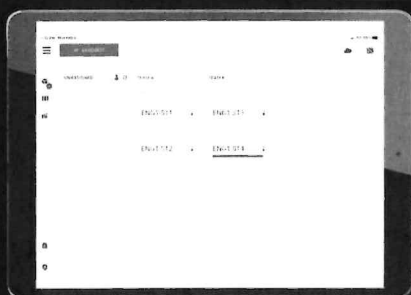

INVENTORY MANAGEMENT

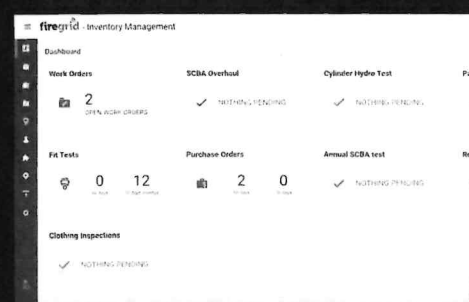

REPORTS AND ANALYTICS

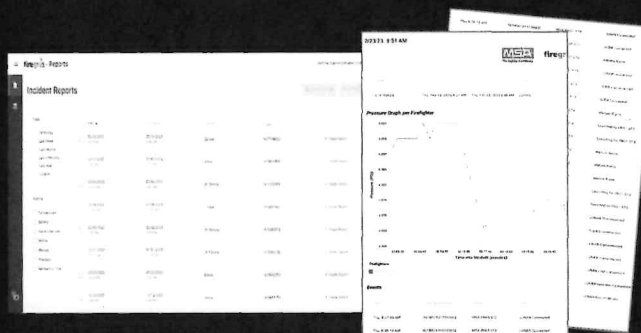

MSA G1 SCBA



The MSA Connected Firefighter Platform is a network of products expanding the connectivity offering of MSA solutions to enhance firefighter safety. The Connected Firefighter Platform is comprised of MSA's cloud-connected products enabling incident command, inventory management compliance as well as reporting and analytics. It includes the G1 SCBA at the center, MSA HUB Fire Service, LUNAR® Connected Device, and FireGrid™.



MSA HUB

The MSA HUB provides a wireless gateway to the cloud, enabling local monitoring of device and personnel data. The MSA HUB creates its own hotspot for local use with no internet connection needed or connects to the cloud via an existing internet connection, inclusive of LTE. It connects to the tablet application for local monitoring and sends all data to the FireGrid web-based platform for post-scene evaluation, reporting and inventory management.

LUNAR CONNECTED DEVICE

As part of MSA's Connected Firefighter Platform, LUNAR® Connected Device and FireGrid provide search and rescue technology, situational awareness, and an enhanced incident command experience—on and off scene. This Connected Firefighter solution aids in locating a downed team member, automatically notifying team members including Incident Command that there is a device in alarm, situational awareness, and connectivity for more informed and confident decision making. LUNAR's direct cloud connection provides device data to Incident Command on MSA's tablet-based local monitoring application and is available for use on FirstNet®, ensuring priority on AT&T's cellular network.



MSA G1 SCBA



G1 SCBA Cylinders

Standard, Lightweight Carbon Cylinders

MSA Standard, Lightweight Carbon Cylinders (also known as SuperLite Cylinders) are a staple in the Fire Service. Available in 2216, 4500, and 5500 psi, these cylinders are durable and lightweight. The cylinder is wound thousands of times with high-strength carbon fibers impregnated with epoxy resin.

A final over-wrap of fiberglass fibers enhances abrasion resistance. Then, a glow-in-the-dark luminescent band is applied for improved night visibility.

Eclipse Cylinders

The Eclipse Cylinder is a new option for the G1 SCBA that provides an exciting, sleek black finish. The Eclipse Cylinders incorporate a lightweight and streamlined design and are available in 4500 psi with 30-minute and 45-minute Low-Profile rated service duration.



MSA G1 SCBA

G1 SCBA Cylinder Options

MSA G1 SCBA Cylinders are available for purchase in a wide variety of options and ability for customization.

Connection Type

Threaded Remote Connection

Threaded Remote Connection is available in CGA 346 (2216 psi) and CGA 347 (4500 and 5500 psi) for a traditional, thread on connection.

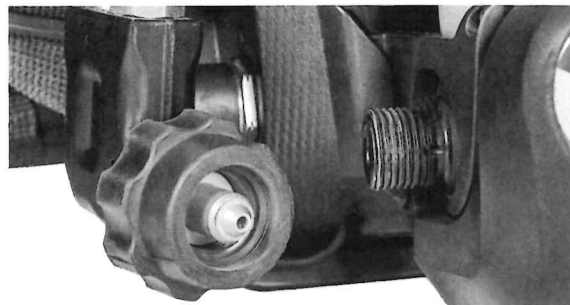

Quick-Connect Remote Connection

The Quick-Connect option is available for rapid, quick changing of cylinders. The Quick-Connect Cylinders come with an installed adapter to easily push-to-connect with the remote handwheel.

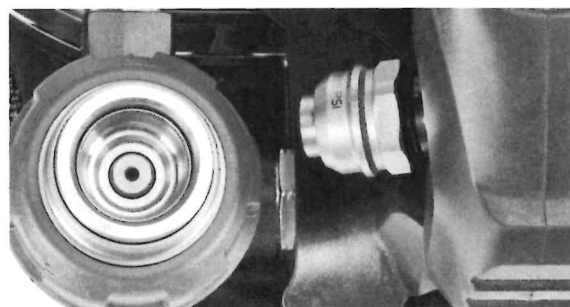

Handwheel Type



Standard Handwheel

The Standard handwheel allows for simple and easy opening and closing of the cylinder valve by turning the handwheel knob.

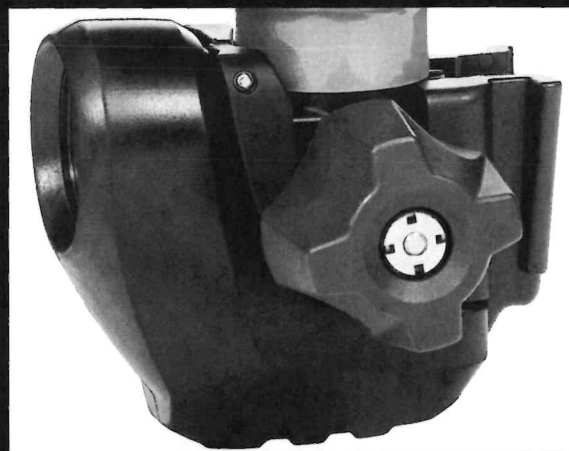

Locking Handwheel

The Locking handwheel locks when the cylinder valve is in an open position. It requires only a simple turning motion of the handwheel to open the cylinder, but to close the cylinder valve the user must pull the handwheel outward and then turn to close.

MSA G1 SCBA



Custom Logo

For easy-to-read cylinder identification, MSA can customize any G1 Cylinder to have a department's logo wrapped under the clear coat of the cylinder.

This customization can be done by either a reflective or paper band in single or multi-color.

Custom Labels



Single Color



Multi Color

G1 SCBA Cylinder Specs

Standard, Lightweight Carbon Cylinders					
Cylinder Pressure	Service Time	Available Breathable Air	Cylinder Height (w/Valve)	Cylinder Diameter	Cylinder Weight (Full)
<i>30-minute Cylinders</i>					
2216 PSI	30 Minutes	45 ft. ³	22.8" (579 mm)	6.7" (170 mm)	11.3 lb. (5.1 kg)
4500 PSI	30 Minutes	45 ft. ³	21.4" (544 mm)	5.4" (137 mm)	10.4 lb. (4.7 kg)
5500 PSI	30 Minutes	45 ft. ³	21.0" (533 mm)	5.0" (127 mm)	9.9 lb. (4.5 kg)
<i>45-minute Cylinders</i>					
4500 PSI	45 Minutes (<i>low-profile</i>)	65 ft. ³	23.1" (587 mm)	6.3" (160 mm)	13.9 lb. (6.3 kg)
4500 PSI	45 Minutes	65 ft. ³	21.0" (533 mm)	6.8" (173 mm)	14.4 lb. (6.5 kg)
5500 PSI	45 Minutes	65 ft. ³	22.7" (577 mm)	5.8" (147 mm)	13.5 lb. (6.1 kg)
<i>60-minute Cylinders</i>					
4500 PSI	60 Minutes	87 ft. ³	23.9" (607 mm)	7.1" (180 mm)	17.2 lb. (7.8 kg)
5500 PSI	60 Minutes	87 ft. ³	22.7" (577 mm)	6.7" (170 mm)	17.4 lb. (7.9 kg)
<i>Eclipse Cylinders</i>					
4500 PSI	30 Minutes	45 ft. ³	21.7" (551 mm)	5.4" (137 mm)	10.2 lb. (4.6 kg)
4500 PSI	45 Minutes (<i>low-profile</i>)	65 ft. ³	23.5" (597 mm)	6.1" (155 mm)	13.5 lb. (6.1 kg)



2216 psi Standard
yellow band



4500 psi Standard
green band



5500 psi Standard
blue band



4500 psi Eclipse
green band

MSA G1 SCBA

MSA G1 SCBA Cylinder Ordering Information

MSA G1 SCBA Cylinders for Threaded Remote Connection

Cylinder Pressure	Cylinder Type	Connection Type	Handwheel Type	Air	Less Air
2216 PSIG	30-minute	Threaded	Standard	10156422-SP	10156431-SP
4500 PSIG	30-minute	Threaded	Standard	10156423-SP	10156432-SP
4500 PSIG	45-minute (<i>low-profile</i>)	Threaded	Standard	10156424-SP	10156433-SP
4500 PSIG	45-minute	Threaded	Standard	10156425-SP	10156434-SP
4500 PSIG	60-minute	Threaded	Standard	10156426-SP	10156435-SP
5500 PSIG	30-minute	Threaded	Standard	10185508	10185602
5500 PSIG	45-minute	Threaded	Standard	10185509	10185603
5500 PSIG	60-minute	Threaded	Standard	10185510	10185604

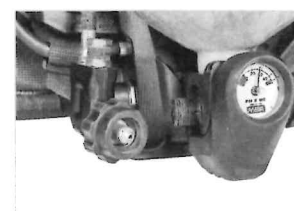

Threaded Remote Connection

MSA G1 SCBA Cylinders for Quick-Connect Remote Connection

Cylinder Pressure	Cylinder Type	Connection Type	Handwheel Type	Air	Less Air
2216 PSIG	30-minute	Quick-Connect	Standard	10175706	10175711
4500 PSIG	30-minute	Quick-Connect	Standard	10175707	10175712
4500 PSIG	45-minute (<i>low-profile</i>)	Quick-Connect	Standard	10175708	10175713
4500 PSIG	45-minute	Quick-Connect	Standard	10175709	10175714
4500 PSIG	60-minute	Quick-Connect	Standard	10175710	10175715
5500 PSIG	30-minute	Quick-Connect	Standard	10181628	10181708
5500 PSIG	45-minute	Quick-Connect	Standard	10181629	10181709
5500 PSIG	60-minute	Quick-Connect	Standard	10181630	10181710

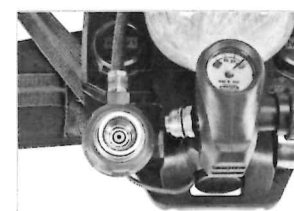

Threaded Remote Connection

MSA G1 SCBA Standard Cylinders for Threaded & Quick-Connect Remote Connection w/Locking Handwheel

Cylinder Pressure	Cylinder Type	Connection Type	Handwheel Type	Air	Less Air
4500 PSIG	30-minute	Threaded	Locking	10191802	10191838
4500 PSIG	45-minute (<i>low-profile</i>)	Threaded	Locking	10191806	10191842
4500 PSIG	45-minute	Threaded	Locking	10191804	10191840
4500 PSIG	60-minute	Threaded	Locking	10191808	10191844
4500 PSIG	30-minute	Quick-Connect	Locking	10191803	10191839
4500 PSIG	45-minute (<i>low-profile</i>)	Quick-Connect	Locking	10191807	10191843
4500 PSIG	45-minute	Quick-Connect	Locking	10191805	10191841
4500 PSIG	60-minute	Quick-Connect	Locking	10191809	10191845

MSA G1 SCBA

MSA G1 SCBA Eclipse Cylinders

Cylinder Pressure	Cylinder Type	Connection Type	Handwheel Type	Air	Less Air
4500 PSIG	30-minute	Threaded	Standard	10204941	10204965
4500 PSIG	45-minute (<i>low-profile</i>)	Threaded	Standard	10204945	10204969
4500 PSIG	30-minute	Quick-Connect	Standard	10204942	10204966
4500 PSIG	45-minute (<i>low-profile</i>)	Quick-Connect	Standard	10204946	10204970
4500 PSIG	30-minute	Threaded	Locking	10204943	10204967
4500 PSIG	45-minute (<i>low-profile</i>)	Threaded	Locking	10204947	10204971
4500 PSIG	30-minute	Quick-Connect	Locking	10204944	10204968
4500 PSIG	45-minute (<i>low-profile</i>)	Quick-Connect	Locking	10204948	10204972

MSA G1 SCBA Cylinder Accessories

Part Number	Description
10149701-SP	Quick-Connect adapter for 2216 psig cylinders
10149702-SP	Quick-Connect adapter for 4500/5500 psig cylinders
10158389	Retainer kit for 4500 psig, 30-min. cylinder (type 2 dovetail)
10158390	Retainer kit for 4500 psig, 45-min. low-profile cylinder (type 3 dovetail)
10158401	Retainer kit for 4500 psig, 45-min. cylinder (type 4 dovetail)
10158402	Retainer kit for 4500 psig, 60-min. cylinder (type 5 dovetail)
10162403	Quick-Connect adapter for fill station
10183992	Kit, protective cap & boot for 30-min. cylinder
10183993	Kit, protective cap & boot for 45-min. low-profile cylinder

**Cap & Boot**

The Cap & Boot provide a protective, rubber cover to the top and bottom of the cylinder. Only available for Standard, Lightweight Carbon Cylinders in 30-minute and 45-minute LP 4500 psi.

MSA G1 SCBA Accessories

Part Number	Description
10148740-SP	Replacement alkaline battery pack
10148741-SP	Replacement rechargeable battery pack
10158385	Rechargeable battery charging station
10164940	G1 Custom Tool Kit
10083875	RFID Tag
10158407	RFID reader/writer (primary use with A2)
10186214	RFID read only (primary use with AIMS)
10175010-SP	G1 Control Module w/ Integrated TIC upgrade kit - 2216 psig
10175021-SP	G1 Control Module w/ Integrated TIC upgrade kit -4500/5500 psig

MSA G1 SCBA Facepieces

Part Number	Type	Size	Nosecup Size	Head Harness	ATO Configuration
10156458	Fire service	Small	Small	4-pt. adjustable	G1FP-F-S-1-S-4-0-1
10156459	Fire service	Medium	Medium	4-pt. adjustable	G1FP-F-M-1-M-4-0-1
10156460	Fire service	Large	Large	4-pt. adjustable	G1FP-F-L-1-L-4-0-1
10156461	Fire service	Small	Small	Rubber	G1FP-F-S-1-S-R-0-1
10156462	Fire service	Medium	Medium	Rubber	G1FP-F-M-1-M-R-0-1
10156463	Fire service	Large	Large	Rubber	G1FP-F-L-1-L-R-0-1
10161812	Fire service	Small	Small	5-pt. adjustable	G1FP-F-S-1-S-5-0-1
10161813	Fire service	Medium	Medium	5-pt. adjustable	G1FP-F-M-1-M-5-0-1
10161814	Fire service	Large	Large	5-pt. adjustable	G1FP-F-L-1-L-5-0-1



MSA SCBA Facepiece Accessories

Part Number	Description
496081	PAPR Type H filter cartridge (6-pk.)
10042346	PAPR Type H filter cartridge (20-pk.)
10067469	P100/OV canister (1-pk.)
10094315	P100/OV canister (12-pk.)
10144230	Spectacle Kit for G1 Facepiece
10152979	Riot control P100/CN/CS canister (1-pk.)
10160594	Multigas GME/CS/CN/P100 cartridge (1-pk.)

Part Number	Description
805078	Quik Chek® Fit Test Adapter
10144220-SP	Replacement cloth neck strap
10159699-SP	Replacement rubber neck strap
10144231-SP	APR filter adapter assembly
10189322	G1 CBRN Nosecup, Large
10189323	G1 CBRN Nosecup, Medium/Small
10046570	CBRN Canister
10144230	G1 Spectacle Kit

Ordering Selection Matrix

A Application

F Fire

B Size

S Small
M Medium
L Large

C Material

1 Hycar

D Nosecup

0 None
S Small
M Medium
L Large

E Head Harness

0 None
4 4 pt Adjustable
5 5 pt Adjustable
R Rubber

F Neckstrap

0 None
C Cloth
R Rubber

G Regulator Connection

1 Fixed Push-to- Connect

Note:

Part numbered facepieces are also available
An additional surcharge will be added to configurations that are classified as hazardous materials

A-G1FP			1				1	Quantity
	A	B	C	D	E	F	G	

PART NUMBER



MSA G1 SCBA Fire Service Edition

Ordering Selection Matrix

A System Pressure

- 4 4500 psig
- 5 5500 psig ^[1]

B Cylinder Connection

- 2 CGA Threaded Remote Connection
- 4 CGA Quick Connect Remote Connection

C Harness

- 3 Serviceable Tunnel without Chest Strap
- 4 Serviceable Tunnel with Chest Strap
- 9 Serviceable Tunnel without Chest Strap No PASS
- 10 Serviceable Tunnel with Chest Strap No PASS

D Cradle Type

- M Metal Band

E Lumbar Type

- A Adjustable Swiveling Lumbar Pad
- D Adjustable Swiveling, Solid buckle
- P Low Profile Swiveling Lumbar Pad
- R Low Profile Swiveling Lumbar Pad, Solid Buckle
- 1 Rescue Belt II Crosby Hook, 50'
- 2 Rescue Belt II Carabiner, 50'
- 8 Rescue Belt II Lightning GT Hook, 50' Aramid/ Nylon Rope

F Regulator Type

- 1 Purge Cover T4 Left Shoulder
- 2 Solid Cover T4 Left Shoulder

G Regulator Hose Type

- C Continuous
- Q Quick Connect

H Emergency Breathing Support

- 0 None
- 1 Waist Mounted Quick-Fill ^[1]
- 2 ExtendAire II
- 3 Waist Mounted Quick-Fill and ExtendAire II ^[1]
- 4 Hose and pouch
- 5 Waist-mounted Quick-Fill w/hose and pouch ^[1]
- 6 ExtendAire II w/ hose and pouch
- 7 Waist-mounted Quick-Fill w/hose and pouch, ExtendAire II ^[1]

- A Pouch only

J Speaker Module

- L Left Chest ^[2]
- 0 None

K PASS

- A PASS Right Shoulder ^[2]
- C PASS Telemetry Right Shoulder ^[2]
- E PASS Right Shoulder w/ Integrated TIC ^[2]
- G PASS Telemetry Right Shoulder w/ Integrated TIC ^[2]
- H No PASS Right Shoulder ^{[2][4]}
- J No PASS Telemetry Right Shoulder ^{[2][4]}
- K No PASS Right Shoulder w/ Integrated TIC ^{[2][4]}
- L No PASS Telemetry Right Shoulder w/ Integrated TIC ^{[2][4]}

L Battery Type

- A Alkaline
- R Rechargeable ^[3]

Notes:
If Telemetry is ordered R must be selected.

Key:

- ^[1] SCBA to SCBA Transfiling is not available with the 5500psig operating system
- ^[2] As Worn
- ^[3] Charger sold separately
- ^[4] Can only be combined with Harness option 9 or 10

Note:

An additional surcharge will be added to configurations that are classified as hazardous materials

A-GIFS													Qty
	A	B	C	D	E	F	G	H	J	K	L		

PART NUMBER

Note: This Bulletin contains only a general description of the products shown. While product uses and performance capabilities are generally described, the products shall not, under any circumstances, be used by untrained or unqualified individuals. The products shall not be used until the product instructions/user manual, which contains detailed information concerning the proper use and care of the products, including any warnings or cautions, have been thoroughly read and understood. Specifications are subject to change without prior notice. MSA is a registered trademark of MSA Technology, LLC in the US, Europe, and other Countries. For all other trademarks visit <https://us.msasafety.com/Trademarks>.

MSA operates in over 40 countries worldwide. To find an MSA office near you, please visit [MSAsafety.com/offices](https://us.msasafety.com/offices).



360 Production Drive
South Elgin, IL 60177-2637
Phone: 888-247-1204
Fax: 847-289-9001
Email: airone@aoe.net

G1 SCBA TRAINING PLAN

(3) Days of training (each shift) or until personnel are comfortable with SCBA units. Normally, 2-3 hours of training required per day. Training dates to be determined per fire department's request. Future training as needed by fire department. Training is at no charge to fire department.

PREVENTITIVE MAINTENANCE

- 1) No labor charge for warranty parts replaced during warranty period. (15 years)
- 2) Air One Equipment, Inc. 24/7 emergency service available.
- 3) (8) factory trained MSA service technicians
- 4) Loaner SCBA available
- 5) (6) Mobile service trucks working/traveling in the States of Illinois/Wisconsin
- 6) On-Site Annual NFPA Flow Testing.

ONGOING MAINTENANCE AND SUPPORT

Manufacturer recommends annual flow testing of SCBA units and facepieces. Hydrostatic testing of air cylinders every (5) years per D.O.T. **1-888-247-1204** for 24-hour emergency service. 24-48 hour response time for repairs. Emergencies are next day. (8) MSA SCBA trained technicians.



360 Production Drive
South Elgin, IL 60177-2637
Phone: 888-247-1204
Fax: 847-289-9001
Email: airone@aoe.net

SERVICE AND REPAIR FACILITIES

Air One Equipment, Inc.
360 Production Drive
South Elgin, Il 60177
(847) 289-9000

Air One Equipment, Inc.
N50W13740 Overview Drive, Unit F
Menomonee Falls, WI 53051
(262) 373-1890

Air One Equipment, Inc.
1201 East Bell
Bloomington, IL 61701
(309) 373-1890

MSA – The Safety Company

MSA G1 SCBA

Limited Warranty and Terms of Sale

Express Warranty — MSA - The Safety Company (MSA) warrants MSA G1 SCBA (SCBA) to be free from defects in materials and/or faulty workmanship for a period of fifteen (15) years from the date of sale by MSA. This warranty applies to all components* of the SCBA including all accessories and optional equipment purchased and supplied at the time of the original sale. MSA's obligation under this warranty is limited to the repair or replacement, at MSA's option, of the SCBA or components shown to be defective in either workmanship or materials.

No agent, employee or representative of MSA may bind MSA to any affirmation, representation or modification of the warranty concerning the goods sold under this contract.

MSA shall be released from all obligations under this warranty in the event that repairs or modifications are made by persons other than its own or authorized service personnel, or if the warranty claim results from accident, alteration, misuse, or abuse.

*This warranty expressly excludes the G1 SCBA Integrated Thermal Imaging Camera. For warranty information regarding the G1 SCBA Integrated Thermal Imaging Camera please see the *G1 SCBA Integrated Thermal Imaging Camera Warranty*.

THIS WARRANTY IS IN LIEU OF ALL OTHER WARRANTEES, EXPRESSED, IMPLIED, OR STATUTORY INCLUDING, BUT NOT LIMITED TO, ANY IMPLIED WARRANTY OF MERCHANTABILITY OR FITNESS FOR A PARTICULAR PURPOSE. IN ADDITION, MSA EXPRESSLY DISCLAIMS ANY LIABILITY FOR ECONOMIC, SPECIAL, INCIDENTAL, OR CONSEQUENTIAL DAMAGES IN ANY WAY CONNECTED WITH THE SALE OR USE OF MSA PRODUCTS, INCLUDING, BUT NOT LIMITED TO, LOSS OF ANTICIPATED PROFITS.



4111 Rev 0 10162874
ID 0105-176-MC/Aug 2017
© MSA 2015 Printed in U.S.A

MSA – The Safety Company
1000 Cranberry Woods Drive
Cranberry Township, PA 16066
Phone 724-776-8600
www.MSAFire.com

Fire Service Customer Service Center
Phone 1-877-MSA-FIRE
Fax 1-800-967-0398

MSA Canada
Phone 1-800-672-2222
Fax 1-800-967-0398

MSA Mexico
Phone 01 800 672 7222
Fax 52-44 2227 3943

MSA International
Phone 724-776-8626
Toll-Free 1-800-672-7777
Fax 724-741-1553



